

# 4

## UNI Dicht

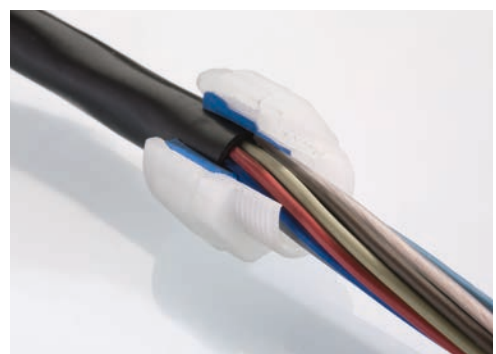

## Die bewährte UNI Dicht – metrisch

*Reliable and tested: UNI Dicht –  
metric*



Abb. 1 – UNI Mehrfach mit geteiltem Dichteinsatz für konfektionierte  
Kabel  
Fig. 1 – UNI Multiple with split sealing insert for pre-assembled cables

### Anwendungsorientierte Individualität

Das PFLITSCH Kabelverschraubungssystem UNI Dicht erfüllt mit seiner Typenvielfalt viele weltweite Anforderungen an Kabel- und Leitungseinführungen. Dabei können EMV- und Ex-Schutz ebenso realisiert werden wie das Einführen von Flach- und Sonderkabeln (z. B. ASi-Bus) oder konfektionierten Kabeln durch geteilte Dichteinsätze. Aber auch Mehrfach-Kabelverschraubungen oder Winkel- und Flanschverschraubungen können verwendet werden. Zudem sind Kombinationen mit Wellrohren und Schutzschläuchen für einen umfassenden mechanischen Kabelschutz möglich.

### Individualität in Metall und Kunststoff

Die UNI Dicht Kabelverschraubung besteht aus dem Verschraubungskörper und dem gewünschten Dichteinsatz. Aus diesen Systemteilen stellt sich der Anwender seine individuelle Verschraubung zusammen – passend zu Einsatzbedingungen, Kabeldurchmessern, Umgebungstemperaturen, Anzahl der Kabel usw. Das ist Individualität in Serienqualität!

UNI Dicht gibt es in den aktuellen Größen M4 bis M120, weiterhin aber auch mit den gängigen Pg-Anschlussgewinden und mit internationalen Sondergewinden wie NPT- oder Zoll-Gewinden. Die Verschraubungskörper sind verfügbar in den Metallen Messing, Zink, Edelstahl und in den Kunststoffen PVDF, Polycarbonat sowie weiteren Materialien auf Anfrage. Die Dichteinsätze fertigt PFLITSCH aus den hochwertigen Materialien TPE, TPE-V und Silikon. Die eingesetzten Werkstoffe sind somit gegen eine Vielzahl unterschiedlichster Chemikalien resistent. Darüber hinaus erfüllen UNI Dicht Kabelverschraubungen serienmäßig hohe Schutzarten bis zu IP 68 (bis 10 bar) bzw. IP 69.

### Baukastensystem für alle Anforderungen

Entsprechend den Einsatzanforderungen der Anwendung kann eine individuelle Kabelverschraubung zusammengestellt werden. Die benötigte Sonderkabelverschraubung mit Pg-Anschlussgewinde für Ihre Applikation ist nicht im Katalog aufgeführt? Viele Sonderlösungen aus dem UNI Dicht Baukastensystem mit metrischem Gewinde sind auf Anfrage auch mit Pg-Anschlussgewinde erhältlich. Auch das „Lochen nach Wunsch“ ist auf Anfrage möglich.

### Application-specific individuality

With its broad variety of types, the PFLITSCH cable gland system UNI Dicht fulfils all the EU requirements for cable entries. Solutions for EMC and explosion protection can be realised and flat and special cables (e.g. ASi bus) or pre-assembled cables fed through split sealing inserts. Multiple cable glands or elbow and flange glands can also be used. Combinations with corrugated conduits and protective hoses for comprehensive mechanical cable protection are likewise possible.

### Individuality in metal and plastic

The UNI Dicht gland comprises the gland body and an individual sealing insert. Users assemble their individual gland from these system components according to the operating conditions, cable diameters, ambient temperatures, number of cables, etc. We call this individuality in serial quality!

UNI Dicht currently comes in sizes M4 to M120 as well as with the widely used Pg connection threads or with special international threads such as NPT or imperial. The system is available in brass, zinc, stainless steel as well as in the plastics PVDF, polycarbonate and other materials on request. PFLITSCH manufactures the sealing inserts from high-grade TPE, TPE-V and silicone (LSR). The materials used are therefore resistant to a wide range of chemicals. Furthermore, UNI Dicht cable glands achieve high protection ratings of up to IP 68 (up to 10 bar) or IP 69 as standard.

### Modular system for all requirements

Individual cable glands can be assembled to meet specific application requirements. Is the special cable gland with Pg connection thread you need for your application not listed in the catalogue? Many special solutions from the UNI Dicht modular system with metric threads are also available with Pg connection threads on request, as are customised hole patterns.



PFLITSCH Produktsuche



PFLITSCH product search



Abb. 1 – Kabelverschraubung mit geschlossenem Dichteinsatz  
Fig. 1 – Cable gland with closed sealing insert

Abb. 2 – UNI Biegeschutz Dicht Kabelverschraubung  
Fig. 2 – UNI Dicht Bending protection cable gland

Abb. 3 – UNI Dicht Varianten in einer Schaltschrankanwendung  
Fig. 3 – UNI Dicht variants in a control cabinet application

**DS = Druckschraube**  
DS = pressure screw

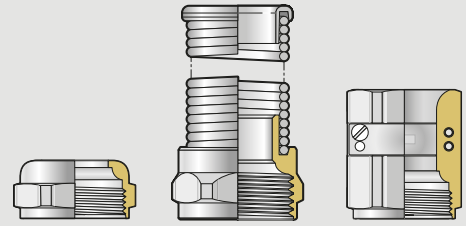

## Das PFLITSCH System UNI Dicht metrisch Systemteile/Seitenübersicht

The PFLITSCH system  
UNI Dicht metric  
System components/page overview

Werkstoff Material	Standard Standard	UNI Flex UNI Flex	UNI Klemm UNI Clamping
Messing Brass	Seite 72-73 Page 72-73	Seite 116 Page 116	Seite 111 Page 111
Edelstahl Stainless steel	Seite 74-75 Page 74-75		
Polycarbonat Polycarbonate	Seite 76 Page 76		
PVDF PVDF	Seite 77-78 Page 77-78		

**E = Dichteinsatz**  
E = sealing insert



Werkstoff Material	Standard Standard	Erweitert kurz Extended short	Erhöhte Zugentlastung Increased strain relief	EMV HF EMC HF	EMV-Konus EMC cone	Mehrfach Form N Multiple form N
TPE TPE	Seite 72-79 Page 72-79	Seite 82-85 Page 82-85	Seite 108-111 Page 108-111	Seite 208-210 Page 208-210	Seite 228-229 Page 228-229	Seite 88 Page 88
TPE-V TPE-V	Seite 72-79 Page 72-79	Seite 82-85 Page 82-85	Seite 108-111 Page 108-111	Seite 208-210 Page 208-210	Seite 228-229 Page 228-229	Seite 88 Page 88
Silikon Silicone	Seite 72-79 Page 72-79	Seite 82-85 Page 82-85	Seite 111 Page 111	Seite 208-210 Page 208-210	Seite 228 Page 228	Seite 95 Page 95

**DN = Doppelnippel**  
DN = double nipple



Werkstoff Material	Gewindelänge Standard Standard thread length
Messing Brass	Seite 72-73 Page 72-73
Edelstahl Stainless steel	Seite 74-75 Page 74-75
Polycarbonat Polycarbonate	Seite 76 Page 76
PVDF PVDF	Seite 77-78 Page 77-78
Zink Zinc	

**DS & DN = VK (Verschraubungskörper)**  
DS & DN = VK (gland body)

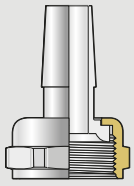

**Glatte Schläuche dünnwandig**  
*Plain, thin-walled hoses*

Seite 365  
Page 365

Auf Anfrage  
On request

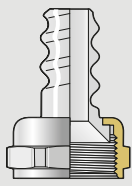

**UL-Schlauch**  
*UL hose*

Seite 363  
Page 363

Auf Anfrage  
On request

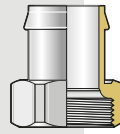

**Glatte Schläuche**  
*Plain hose*

Seite 367-368  
Page 367-368

Auf Anfrage  
On request

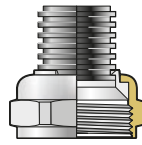

**UNI Wellrohr**  
*UNI corrugated conduit*

Seite 350  
Page 350

Auf Anfrage  
On request



**Mehrfach Form E**  
*Multiple form E*

Seite 88  
Page 88

Auf Anfrage  
On request

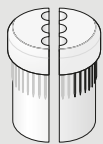

**Mehrfach – geteilt**  
*Multiple – split version*

Seite 97-98  
Page 97-98



**Geschlossen**  
*Closed*

Auf Anfrage  
On request

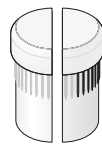

**Geschlossen – geteilt**  
*Closed – split version*

Seite 97-98  
Page 97-98

Auf Anfrage  
On request



**Flachkabel**  
*Flat cable*

Seite 100-104  
Page 100-104

Seite 100-104  
Page 100-104



**ASi-Bus-Kabel**  
*ASi bus cable*

Seite 99  
Page 99

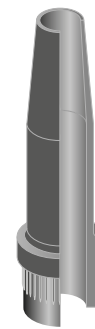

**Biegeschutz**  
*Bending protection*

Seite 113-115  
Page 113-115



**Biegeschutz/erhöhte Zugentlastung**  
*Bending protection incl. strain relief*

Seite 117-119  
Page 117-119

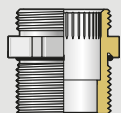

**Gewindelänge lang**  
*Long thread length*

Seite 72-73, 79  
Page 72-73, 79

Seite 74-75  
Page 74-75

Seite 77  
Page 77

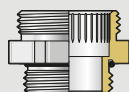

**Form E erweitert**  
*Form E extended*

Seite 82  
Page 82

Seite 83  
Page 83

Seite 84  
Page 84

Seite 85  
Page 85

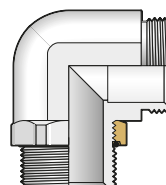

**Winkel**  
*Elbow*

Seite 338-343  
Page 338-343

**Das PFLITSCH System**  
**UNI Dicht metrisch**  
**Aufbau der Artikelnummern**

*The PFLITSCH system*  
*UNI Dicht metric*  
*Article number structure*

	<b>Anschluss- gewinde:</b>	<b>Kopfgewinde:</b>
	<i>Connection thread:</i>	<i>Head thread:</i>
	10 = M10x1,0	49 = Pg 7
	10 = M10x1,5	50 = Pg 9
2 = metrisch	12 = M12x1,5	51 = Pg 11
2 = <i>metric</i>	16 = M16x1,5	52 = Pg 13,5
8 = metrisch, lang	20 = M20x1,5	53 = Pg 16
8 = <i>metric, long</i>	25 = M25x1,5	54 = Pg 21
Weitere Gewinde:	32 = M32x1,5	55 = Pg 29
Zoll, NPT	40 = M40x1,5	56 = Pg 36
<i>Other threads:</i>	50 = M50x1,5	57 = Pg 42
<i>Imperial, NPT</i>	63 = M63x1,5	58 = Pg 48

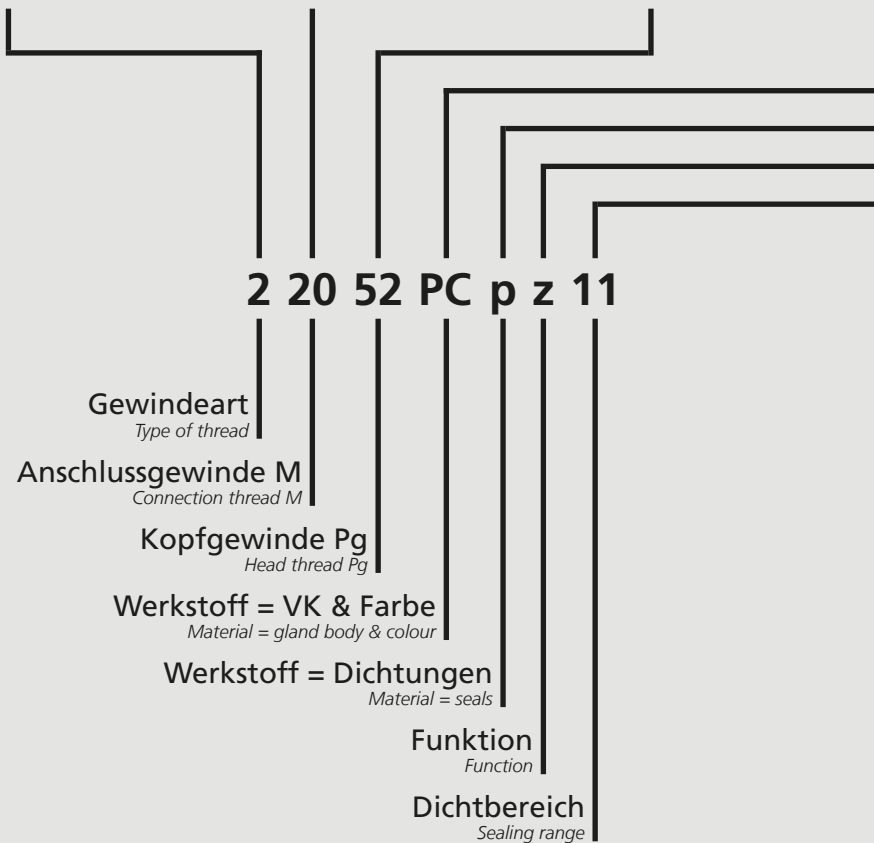

## Werkstoffe

### Verschraubungskörper:

*Materials gland body:*

d	= Messing vernickelt <i>Brass, nickel-plated</i>	
st	= Edelstahl 1.4305 <i>AISI 303</i>	
PC	= Polycarbonat <i>Polycarbonate</i>	
PCn	= Polycarbonat <i>Polycarbonate</i>	Farbe Schwarz <i>Colour black</i>
PCw	= Polycarbonat <i>Polycarbonate</i>	Winkel <i>Elbow</i>
y	= PVDF	Farbe Transparent <i>Colour transparent</i>
ya	= PVDF	Farbe Blau <i>Colour blue</i>
yn	= PVDF	Farbe Schwarz <i>Colour black</i>
VW	= Zink <i>Zinc</i>	Winkel <i>Elbow</i>

## Werkstoffe Dichtungen:

*Materials seals:*

-	= TPE
p	= TPE-V
H	= Silikon HT <i>Silicone HT</i>
B	= T80s
Bi	= S55

## Funktion:

*Function:*

-	= Standard-Dichteinsatz <i>Standard sealing insert</i>
z	= Zugentlastung <i>Strain relief</i>
e	= Entstörung <i>Interference suppression</i>
ez	= Entstörung & Zugentlastung <i>Interference suppression &amp; strain relief</i>
L	= Biegeschutz <i>Bending protection</i>
Lz	= Biegeschutz & Zugentlastung <i>Bending protection &amp; strain relief</i>
m	= Mehrfach <i>Multiple</i>
mK	= Multifunktion (Stecker) <i>Multi-function (connector)</i>

s	= Schlauch <i>Hose</i>
f...g	= flach, gerundet <i>Flat, rounded</i>
f...v	= flach, oval <i>Flat, oval</i>
f...e	= flach, eckig <i>Flat, angular</i>
F	= Flex <i>Flex</i>
W	= Wellrohr <i>Corrugated conduit</i>
UL	= UL-Schlauchverschraubung <i>UL hose gland</i>
g	= geschlossen <i>Closed</i>

## Dichtbereich:

*Sealing range:*

7	= 6,5 – 4,0
8	= 8,0 – 5,0
9	= 9,5 – 6,5
11	= 10,5 – 7,0
13	= 13,0 – 9,0
16	= 15,5 – 11,5
18	= 18,0 – 14,0
20	= 20,5 – 17,0
25	= 25,0 – 20,0
28	= 28,0 – 24,0
32	= 32,0 – 27,0
34	= 34,0 – 29,0
36	= 36,0 – 32,0
40	= 40,0 – 36,0
44	= 44,0 – 39,0

## Das PFLITSCH System UNI Dicht – Komponenten

The PFLITSCH system  
UNI Dicht – components

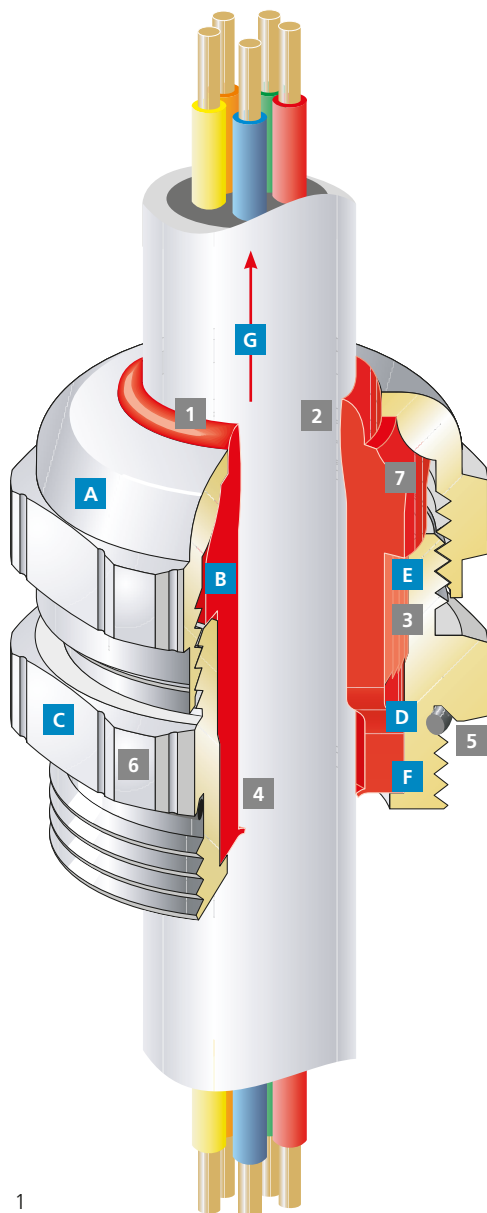

1

Abb. 1 – Querschnitt einer UNI Dicht Kabelverschraubung  
Fig. 1 – Cross section of a UNI Dicht cable gland

### Komponenten:

Components:

- A** Druckschraube (DS)  
Pressure screw (DS)  
- Messing/Messing bleifrei, galvanisch vernickelt  
Brass/lead-free brass, galvanically nickel-plated  
- Edelstahl 1.4305  
Stainless steel AISI 303  
- Edelstahl 1.4571  
Stainless steel AISI 316 Ti  
- Kunststoff: Polycarbonat (PC)  
Plastic: Polycarbonate (PC)  
- Hochleistungskunststoff PVDF  
High-performance plastic PVDF
- B** Dichteinsatz (E, Ek)  
Sealing insert (E, Ek)  
- TPE  
TPE  
- TPE-V  
TPE-V  
- Silikon HT  
Silicone HT
- C** Doppelnippel (DN)  
Double nipple (DN)  
- Messing/Messing bleifrei, galvanisch vernickelt  
Brass/lead-free brass, galvanically nickel-plated  
- Edelstahl 1.4305  
Stainless steel AISI 303  
- Edelstahl 1.4571  
Stainless steel AISI 316 Ti  
- Kunststoff: Polycarbonat (PC)  
Plastic: Polycarbonate (PC)  
- Hochleistungskunststoff PVDF  
High-performance plastic PVDF
- D** O-Ring  
O-ring  
Bei metallischen Doppelnippeln (DN)  
With metal double nipple (DN)  
- Kautschuk (HNBR)  
Rubber (HNBR)  
- Silikon HT  
Silicone HT
- E** Kopfgewinde  
Head thread  
- Standard  
Standard  
- Erweitert – für Varianten mit größeren Dichtbereichen  
Extended – for variants with larger sealing ranges  
- Reduziert (auf Anfrage) – für kompakte Bauformen und kleine Kabeldurchmesser  
Reduced (on request) – for compact designs and small cable diameters
- F** Anschlussgewinde  
Connection thread  
- Metrisch  
Metric  
- Pg  
Pg  
- NPT  
NPT  
- Zoll  
Imperial  
- Standard/Lang  
Standard/long
- G** Sehr hohe Auszugskräfte (EN 62444, bis Klasse A)  
High strain relief (EN 62444 up to class A)



### Vorteile:

Advantages:

- 1 - IP 68 bis 10 bar zum Kabel und zur Druckschraube  
IP 68 up to 10 bar to the cable and pressure screw
- 2 - Radialsymmetrisch weiche Kabelpressung  
Radially symmetrical soft cable pressing
  - Großflächige Zugentlastung  
Strain relief over a large area
  - Keine Beschädigung des Kabels  
No damage to the cable
- 3 - Verdrehenschutz durch Rändelung am Doppelnippel (DN) und Dichteinsatz (E, EK)  
Anti-twist protection with knurling of the double nipple (DN) and sealing insert (E, EK)
  - Kein Verdrehen des Kabels bei Montage/Demontage  
No twisting of the cable during installation/disassembly
- 4 - IP 54 durch Membrane am Dichteinsatz ohne Anziehen der Druckschraube (DS)  
IP 54 due to diaphragms on the sealing insert without tightening the pressure screw (DS)
- 5 - Nutgeführter O-Ring sichert Abdichtung zum Gehäuse  
O-ring held in the groove provides seal to the enclosure
- 6 Das PFLITSCH Markenzeichen – zwölf Riefen als Zeichen für Innovation und Qualität  
The PFLITSCH trademark – twelve grooves as a sign of innovation and quality
- 7 - Farbcodierung der TPE-Dichteinsätze (E, EK), zur eindeutigen Zuordnung der Dichteinsätze zu den verwendeten Kabeldurchmessern  
Colour coding of the TPE sealing inserts (E, EK) for clear assignment of the inserts to the cable diameters used
  - Erhältlich in verschiedenen Materialien  
Available in different materials



### UNI Farbcode (FC) für TPE-Dichteinsätze

UNI colour code (CC) for TPE sealing inserts

	Farbcode FC Colour code CC	Dichtbereich Sealing range max./min. Ø	Anschlussgewinde Connection thread
	<b>Gelb</b> Yellow	(ge) 6,5 – 4,0	M10, M12, M16, M20, M25 Pg 7, Pg 9, Pg 11, Pg 13,5, Pg 16
	<b>Grau</b> Grey	(gu) 8,0 – 5,0	M12, M16, M20, M25 Pg 9, Pg 11, Pg 13,5, Pg 16
	<b>Schwarz</b> Black	(sw) 9,5 – 6,5	M12, M16, M20, M25 Pg 9, Pg 11, Pg 13,5, Pg 16
	<b>Grün</b> Green	(gr) 10,5 – 7,0	M16, M20, M25, M32 Pg 11, Pg 13,5, Pg 16, Pg 21
	<b>Rot</b> Red	(rt) 13,0 – 9,0	M16, M20, M25, M32 Pg 9, Pg 13,5, Pg 16, Pg 21
	<b>Weiß</b> White	(ws) 15,5 – 11,5	M20, M25, M32, M40 Pg 16, Pg 21, Pg 29
	<b>Blau</b> Blue	(bl) 18,0 – 14,0	M20, M25, M32, M40 Pg 16, Pg 21, Pg 29
	<b>Braun</b> Brown	(br) 20,5 – 17,0	M20, M25, M32, M40 Pg 13,5, Pg 16, Pg 21, Pg 29
	<b>Orange</b> Orange	(or) 25,0 – 20,0	M32, M40 Pg 16, Pg 21, Pg 29
	<b>Hellgelb</b> Light yellow	(hg) 28,0 – 24,0	M32, M40 Pg 16, Pg 21, Pg 29
	<b>Anthrazit</b> Anthracite	(an) 32,0 – 27,0	M32, M40, M50 Pg 21, Pg 29, Pg 36
	<b>Hellblau</b> Light blue	(hb) 34,0 – 29,0	M32, M40, M50 Pg 21, Pg 29, Pg 36
	<b>Rosa</b> Pink	(rs) 36,0 – 32,0	M32, M40, M50 Pg 21, Pg 29, Pg 36
	<b>Weiß</b> White	(ws) 40,0 – 36,0	M50 Pg 36, Pg 42
	<b>Weiß</b> White	(ws) 44,0 – 39,0	M63 Pg 48

Ab Größe M63 standardmäßig weiße Dichteinsätze  
White sealing inserts as standard from size M63

**UNI Dicht Kabelverschraubung**

UNI Dicht cable gland



Abb. 1  
Fig. 1



Abb. 2  
Fig. 2

**Messing vernickelt**  
**Metrisches Anschlussgewinde nach EN 60423**  
**Mit O-Ring aus HNBR**  
**Schutzart IP 68 bis 10 bar, Type 4X**  
**Zugentlastung bis Klasse A, EN 62444**

Brass, nickel-plated  
Metric connection thread according to EN 60423  
With o-ring made of HNBR  
Type of protection IP 68 up to 10 bar, Type 4X  
Strain relief up to class A, EN 62444

**i Gewinde-Varianten:** Standard-Maß D = Art.-Nr. 22052...  
Thread variants: 15 mm Länge = Art.-Nr. 82052...  
Standard size D = Art. no. 22052...  
15 mm length = Art. no. 82052...

Werkstoff Verschraubungskörper Material gland body	Ausführung/Farbe Version/colour	Werkstoff Dichteinsatz Material sealing insert	Farbe Colour	Bestellschlüssel Art. no. supplement	Temperaturbereich min./max. Temperature range (min./max.)
Messing Brass	Vernickelt Nickel-plated	TPE	s. FC See CC		-40 °C / +130 °C
Messing Brass	Vernickelt Nickel-plated	TPE-V	Natur Natural	p	-40 °C / +135 °C
Messing Brass	Vernickelt Nickel-plated	Silikon HT Silicone HT	Schwarz Black	H	-55 °C / +200 °C



Abb. 3  
Fig. 3



Abb. 4 – Ausführung lang, D = 15 mm  
Fig. 4 – Long version, D = 15 mm

Anschlussgewinde/-länge Connection thread/length		Art.-Nr. Art. no.	Dichtbereich Sealing range		Bauhöhe Mounting height	Schlüsselweite Spanner width		
		Ausführung bitte ergänzen Please indicate product details						
		TPE =						
		TPE-V = p						
		Silikon HT/Silicone HT = H						
A	D mm		max./min. ø mm	C mm	SW <sub>1</sub> x E <sub>1</sub> /SW <sub>2</sub> x E <sub>2</sub> mm			
M4x0,7	2,7	204d	1,6 * **	1,6 – 0,9	8,8	6x6,8	50	
M6x0,75	4,5	206d	3 * **	3,0 – 2,5	14,0	8x9	50	
M8x1,0	6,5	208210d	4,5	4,5 – 3,0	15,5	11x12,2	50	
M10x1,0	5,0	21049d	7/1mm	6,5 – 4,0	19,5	14x15,5	50	
M10x1,5	5,0	21049d	7/1,5mm *	6,5 – 4,0	19,5	14x15,5	50	
M12x1,5	5,0	21249d	7 *	6,5 – 4,0	19,0	14x15,5	50	
M16x1,5	6,0	21650d	7	6,5 – 4,0	20,0	18x20/17x18,9	50	
		21650d	8	8,0 – 5,0	20,0	18x20/17x18,9	50	
		21650d	9	9,5 – 6,5	20,0	18x20/17x18,9	50	
M20x1,5	6,5	22052d	7	6,5 – 4,0	21,0	22x24,4	50	
		22052d	8	8,0 – 5,0	21,0	22x24,4	50	
		22052d	9	9,5 – 6,5	21,0	22x24,4	50	
		22052d	11	10,5 – 7,0	21,0	22x24,4	50	
		22052d	13	13,0 – 9,0	21,0	22x24,4	50	
M25x1,5	7,5	22553d	7	6,5 – 4,0	21,0	28x31,2/24x26,7	50	
		22553d	8	8,0 – 5,0	21,0	28x31,2/24x26,7	50	
		22553d	9	9,5 – 6,5	21,0	28x31,2/24x26,7	50	
		22553d	11	10,5 – 7,0	21,0	28x31,2/24x26,7	50	
		22553d	13	13,0 – 9,0	21,0	28x31,2/24x26,7	50	
		22553d	16	15,5 – 11,5	21,0	28x31,2/24x26,7	50	
M32x1,5	8,0	23254d	11	10,5 – 7,0	26,0	35x38,5/30x33,5	25	
		23254d	13	13,0 – 9,0	26,0	35x38,5/30x33,5	25	
		23254d	16	15,5 – 11,5	26,0	35x38,5/30x33,5	25	
		23254d	18	18,0 – 14,0	26,0	35x38,5/30x33,5	25	
		23254d	20	20,5 – 17,0	26,0	35x38,5/30x33,5	25	
M40x1,5	8,0	24055d	16	15,5 – 11,5	29,0	43x47,3/40x43,5	10	
		24055d	18	18,0 – 14,0	29,0	43x47,3/40x43,5	10	
		24055d	20	20,5 – 17,0	29,0	43x47,3/40x43,5	10	
		24055d	25	25,0 – 20,0	29,0	43x47,3/40x43,5	10	
		24055d	28	28,0 – 24,0	29,0	43x47,3/40x43,5	10	

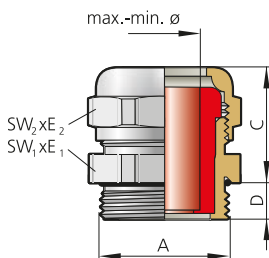
\* Dichteinsatz kurz = Art.-Nr. Ek... \*\* Dichteinsatz aus Silikon HT nicht lieferbar.  
\* Sealing insert short = Art. no. Ek... \*\* Silicone HT sealing insert not available.

Technische Details und Informationen zu Zulassungen ab Seite 419  
For technical details and information on certifications, see page 419 ff.

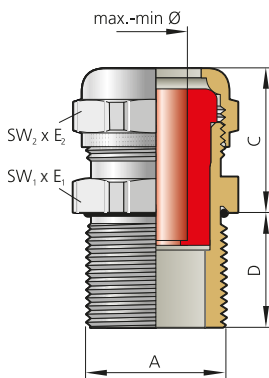
Fortsetzung auf der nächsten Seite  
Continued on next page

## UNI Dicht Kabelverschraubung

UNI Dicht cable gland

Fortsetzung von vorheriger Seite  
Continued from previous page

Anschlussgewinde/-länge Connection thread/length		Art.-Nr. Art. no.	Dichtbereich Sealing range	Bauhöhe Mounting height	Schlüsselweite Spanner width		
Ausführung bitte ergänzen Please indicate product details							
A	D mm	TPE =	max./min. ø mm	C mm	SW <sub>1</sub> x E <sub>1</sub> /SW <sub>2</sub> x E <sub>2</sub> mm		
		TPE-V = p					
		Silikon HT/Silicone HT = H					
M50x1,5	10,0	25056d	32	32,0–27,0	30,0	54x58/50x54	5
		25056d	34	34,0–29,0	30,0	54x58/50x54	5
		25056d	36	36,0–32,0	30,0	54x58/50x54	5
M63x1,5	10,0	26358d	44 *	44,0–39,0	30,0	68x74/64x69	5
M63x1,5	16,0	26375	45 *	45,0–40,0	55,0	81x87	1
		26375	51 *	51,0–45,0	55,0	81x87	1
		26375	56 *	56,0–51,0	55,0	81x87	1
M72x2	16,0	27275	45 *	45,0–40,0	56,0	81x87	1
		27275	51 *	51,0–45,0	56,0	81x87	1
		27275	56 *	56,0–51,0	56,0	81x87	1
M75x1,5	15,0	275212d	47 *	47,0–42,0	46,0	81x87	1
		275212d	52 *	52,0–45,0	46,0	81x87	1
		275212d	55 *	55,0–51,0	46,0	81x87	1
		275212d	58 *	58,0–54,0	46,0	81x87	1
M80x2,0	15,0	280300d	57 *	57,0–50,0	61,0	95x102	1
		280300d	64 *	64,0–58,0	61,0	95x102	1
		280300d	70 *	70,0–63,0	61,0	95x102	1
M90x2	20,0	290400d	76 *	76,0–69,0	62,0	120x128	1
		290400d	85 *	85,0–70,0	62,0	120x128	1
M100x2,0	20,0	2100400d	76 *	76,0–69,0	63,0	120x128	1
		2100400d	85 *	85,0–70,0	63,0	120x128	1
		2100400d	90 *	90,0–75,0	63,0	120x128	1
M120x2,0	30,0	2120500d	100 *	100,0 – 90,0	70,0	145x155	1
		2120500d	110 *	110,0 – 100,0	70,0	145x155	1

\* Dichteinsatz aus Silikon HT nicht lieferbar.  
\* Silicone HT sealing insert not available.

**i** Auf Anfrage erhältlich: Messing bleifrei  
Available on request: Brass, lead-free

**i** Passende Gegenmuttern ab Seite 384  
For matching lock nuts, see from page 384

11400 | ITT00400

**UNI Dicht Kabelverschraubung**

UNI Dicht cable gland



Abb. 1  
Fig. 1

Abb. 2  
Fig. 2

**Edelstahl 1.4305**  
**Metrisches Anschlussgewinde nach EN 60423**  
**Mit O-Ring aus Silikon**  
**Schutzart IP 68 bis 10 bar, Type 4X**  
**Zugentlastung bis Klasse A, EN 62444**

*Stainless steel AISI 303*  
*Metric connection thread according to EN 60423*  
*With o-ring made of silicone*  
*Type of protection IP 68 up to 10 bar, Type 4X*  
*Strain relief up to class A, EN 62444*

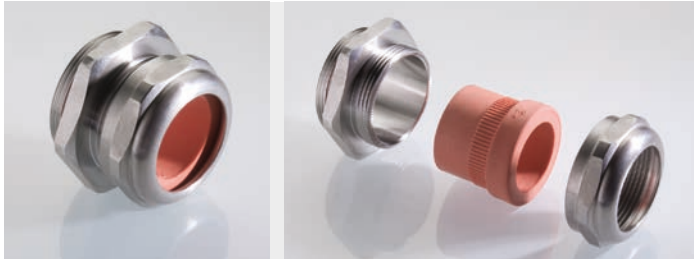
**i Gewinde-Varianten:** Standard-Maß D = Art.-Nr. 22052...  
 15 mm Länge = Art.-Nr. 82052...  
*Thread variants:* Standard size D = Art. no. 22052...  
 15 mm length = Art. no. 82052...

Werkstoff Verschraubungskörper <i>Material gland body</i>	Ausführung/Farbe <i>Version/colour</i>	Werkstoff Dichteinsatz <i>Material sealing insert</i>	Farbe <i>Colour</i>	Bestellschlüssel <i>Art. no. supplement</i>	Temperaturbereich min./max. <i>Temperature range (min./max.)</i>
VA 1.4305 AISI 303	Blank	TPE	s. FC See CC		-40 °C / +130 °C
VA 1.4305 AISI 303	Blank	TPE-V	Natur <i>Natural</i>	p	-40 °C / +135 °C
VA 1.4305 AISI 303	Blank	Silikon HT <i>Silicone HT</i>	Schwarz <i>Black</i>	H	-55 °C / +200 °C



Abb. 3  
Fig. 3



Abb. 4  
Fig. 4

Anschlussgewinde/-länge <i>Connection thread/length</i>		Art.-Nr. <i>Art. no.</i>	Dichtbereich <i>Sealing range</i>	Bauhöhe <i>Mounting height</i>	Schlüsselweite <i>Spanner width</i>		
Ausführung bitte ergänzen <i>Please indicate product details</i>							
A	D mm	TPE = TPE-V = p Silikon HT/Silicone HT = H	max./min. Ø mm	C mm	SW <sub>1</sub> x E <sub>1</sub> /SW <sub>2</sub> x E <sub>2</sub> mm		
M10x1,0	5,0	21049st	7/1mm *	6,5 – 4,0	19,0	14x15,5	50
M10x1,5	5,0	21049st	7/1,5mm *	6,5 – 4,0	19,0	14x15,5	50
M12x1,5	5,0	21249st	7 *	6,5 – 4,0	19,0	14x15,5	50
M16x1,5	6,0	21650st	7	6,5 – 4,0	20,0	19x21/17x18,9	50
		21650st	8	8,0 – 5,0	20,0	19x21/17x18,9	50
		21650st	9	9,5 – 6,5	20,0	19x21/17x18,9	50
M20x1,5	6,5	22051st	7	6,5 – 4,0	20,0	22x24,4	50
		22051st	8	8,0 – 5,0	20,0	22x24,4	50
		22051st	9	9,5 – 6,5	20,0	22x24,4	50
		22051st	11	10,5 – 7,0	20,0	22x24,4	50
		22052st	7	6,5 – 4,0	21,0	22x24,4	50
		22052st	8	8,0 – 5,0	21,0	22x24,4	50
		22052st	9	9,5 – 6,5	21,0	22x24,4	50
		22052st	11	10,5 – 7,0	21,0	22x24,4	50
		22052st	13	13,0 – 9,0	21,0	22x24,4	50
M25x1,5	7,5	22553st	7	6,5 – 4,0	21,0	27x29,5/24x26,7	50
		22553st	8	8,0 – 5,0	21,0	27x29,5/24x26,7	50
		22553st	9	9,5 – 6,5	21,0	27x29,5/24x26,7	50
		22553st	11	10,5 – 7,0	21,0	27x29,5/24x26,7	50
		22553st	13	13,0 – 9,0	21,0	27x29,5/24x26,7	50
		22553st	16	15,5 – 11,5	21,0	27x29,5/24x26,7	50
M32x1,5	8,0	23254st	11	10,5 – 7,0	26,0	36x39,5/30x33,5	25
		23254st	13	13,0 – 9,0	26,0	36x39,5/30x33,5	25
		23254st	16	15,5 – 11,5	26,0	36x39,5/30x33,5	25
		23254st	18	18,0 – 14,0	26,0	36x39,5/30x33,5	25
		23254st	20	20,5 – 17,0	26,0	36x39,5/30x33,5	25
M40x1,5	8,0	24055st	16	15,5 – 11,5	28,0	46x50/41x44,5	10
		24055st	18	18,0 – 14,0	28,0	46x50/41x44,5	10
		24055st	20	20,5 – 17,0	28,0	46x50/41x44,5	10
		24055st	25	25,0 – 20,0	28,0	46x50/41x44,5	10
		24055st	28	28,0 – 24,0	28,0	46x50/41x44,5	10
M50x1,5	10,0	25056st	32	32,0 – 27,0	29,0	55x60,5/50x54	5
		25056st	34	34,0 – 29,0	29,0	55x60,5/50x54	5
		25056st	36	36,0 – 32,0	29,0	55x60,5/50x54	5
M63x1,5	10,0	26358st	44 **	44,0 – 39,0	30,0	68x74/65x70	5

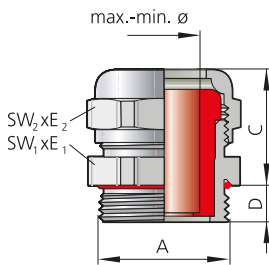
\* Dichteinsatz kurz = Art.-Nr. Ek... \*\* Dichteinsatz aus Silikon HT nicht lieferbar.  
 \* Sealing insert short = Art. no. Ek... \*\* Silicone HT sealing insert not available.

**i Passende Gegenmuttern ab Seite 384**  
*For matching lock nuts, see from page 384*

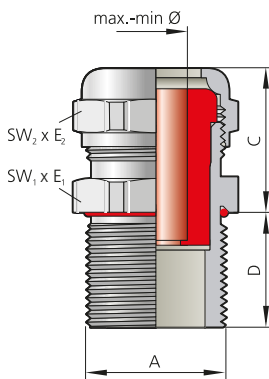
Technische Details und Informationen zu Zulassungen ab Seite 419  
*For technical details and information on certifications, see page 419 ff.*

**UNI Dicht Kabelverschraubung**

UNI Dicht cable gland



Abb. 1  
Fig. 1



Abb. 2  
Fig. 2

**Edelstahl 1.4571**  
**Metrisches Anschlussgewinde nach EN 60423**  
**Mit O-Ring aus Silikon**  
**Schutzart IP 68 bis 10 bar, Type 4X**  
**Zugentlastung bis Klasse A, EN 62444**

*Stainless steel AISI 316Ti*  
*Metric connection thread according to EN 60423*  
*With o-ring made of silicone*  
*Type of protection IP 68 up to 10 bar, Type 4X*  
*Strain relief up to class A, EN 62444*

i	<b>Gewinde-Varianten:</b>	<b>Standard-Maß D</b>	<b>= Art.-Nr. 22052...</b>
		<b>15 mm Länge</b>	<b>= Art.-Nr. 82052...</b>
	<i>Thread variants:</i>	<i>Standard size D</i>	<i>= Art. no. 22052...</i>
		<b>15 mm length</b>	<b>= Art. no. 82052...</b>

Werkstoff Verschraubungskörper <i>Material gland body</i>	Ausführung/Farbe <i>Version/colour</i>	Werkstoff Dichteinsatz <i>Material sealing insert</i>	Farbe <i>Colour</i>	Bestellschlüssel <i>Art. no. supplement</i>	Temperaturbereich min./max. <i>Temperature range (min./max.)</i>
VA 1.4571 AISI 316Ti	Blank	TPE	s. FC See CC		-40 °C / +130 °C
VA 1.4571 AISI 316Ti	Blank	TPE-V	Natur Natural	P	-40 °C / +135 °C
VA 1.4571 AISI 316Ti	Blank	Silikon HT Silicone HT	Schwarz Black	H	-55 °C / +200 °C



Abb. 3  
Fig. 3



Abb. 4  
Fig. 4

Anschlussgewinde/-länge <i>Connection thread/length</i>		Art.-Nr. <i>Art. no.</i>	Dichtbereich <i>Sealing range</i>	Bauhöhe <i>Mounting height</i>	Schlüsselweite <i>Spanner width</i>	
Ausführung bitte ergänzen <i>Please indicate product details</i>						
A	D mm	TPE =	max./min. Ø mm	C mm	SW <sub>1</sub> x E <sub>1</sub> / SW <sub>2</sub> x E <sub>2</sub>	mm
		TPE-V = p				
		Silikon HT/Silicone HT = H				
M12x1,5	5,0	21249st	7 V4A *	6,5– 4,0	19,0	14x15,5
M16x1,5	6,0	21650st	7 V4A	6,5– 4,0	20,0	19x21/17x18,9
		21650st	8 V4A	8,0– 5,0	20,0	19x21/17x18,9
		21650st	9 V4A	9,5– 6,5	20,0	19x21/17x18,9
M20x1,5	6,5	22051st	7 V4A	6,5– 4,0	20,0	22x24,4
		22051st	8 V4A	8,0– 5,0	20,0	22x24,4
		22051st	9 V4A	9,5– 6,5	20,0	22x24,4
		22051st	11V4A	10,5– 7,0	20,0	22x24,4
		22052st	7 V4A	6,5– 4,0	21,0	22x24,4
		22052st	8 V4A	8,0– 5,0	21,0	22x24,4
		22052st	9 V4A	9,5– 6,5	21,0	22x24,4
		22052st	11V4A	10,5– 7,0	21,0	22x24,4
		22052st	13V4A	13,0– 9,0	21,0	22x24,4
M25x1,5	7,5	22553st	7 V4A	6,5– 4,0	21,0	27x29,5/24x26,7
		22553st	8 V4A	8,0– 5,0	21,0	27x29,5/24x26,7
		22553st	9 V4A	9,5– 6,5	21,0	27x29,5/24x26,7
		22553st	11V4A	10,5– 7,0	21,0	27x29,5/24x26,7
		22553st	13V4A	13,0– 9,0	21,0	27x29,5/24x26,7
		22553st	16V4A	15,5– 11,5	21,0	27x29,5/24x26,7
M32x1,5	8,0	23254st	11V4A	10,5– 7,0	26,0	36x39,5/30x33,5
		23254st	13V4A	13,0– 9,0	26,0	36x39,5/30x33,5
		23254st	16V4A	15,5– 11,5	26,0	36x39,5/30x33,5
		23254st	18V4A	18,0– 14,0	26,0	36x39,5/30x33,5
		23254st	20V4A	20,5– 17,0	26,0	36x39,5/30x33,5
		23254st	25V4A	25,0– 20,0	28,0	46x50/41x44,5
M40x1,5	8,0	24055st	16V4A	15,5– 11,5	28,0	46x50/41x44,5
		24055st	18V4A	18,0– 14,0	28,0	46x50/41x44,5
		24055st	20V4A	20,5– 17,0	28,0	46x50/41x44,5
		24055st	25V4A	25,0– 20,0	28,0	46x50/41x44,5
		24055st	28V4A	28,0– 24,0	28,0	46x50/41x44,5
M50x1,5	10,0	25056st	32V4A	32,0– 27,0	29,0	55x60,5/50x54
		25056st	34V4A	34,0– 29,0	29,0	55x60,5/50x54
		25056st	36V4A	36,0– 32,0	29,0	55x60,5/50x54
		25057st	40V4A * **	40,0– 36,0	32,0	60x65
M63x1,5	10,0	26358st	44V4A **	44,0– 39,0	30,0	68x74/65x70

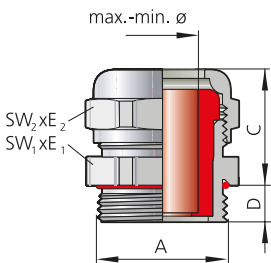
\* Dichteinsatz kurz = Art.-Nr. Ek... \*\* Dichteinsatz aus Silikon HT nicht lieferbar.  
 \* Sealing insert short = Art. no. Ek... \*\* Silicone HT sealing insert not available.

**i** **Passende Gegenmuttern ab Seite 384**  
*For matching lock nuts, see from page 384*

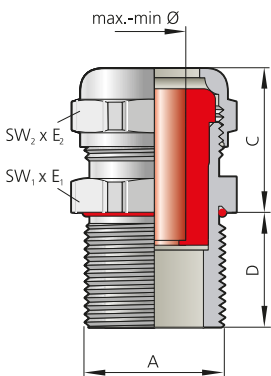
**UNI Dicht Kabelverschraubung**

UNI Dicht cable gland



Abb. 1  
Fig. 1

Abb. 2  
Fig. 2

**Polycarbonat, Farben: Grau (RAL 7035), Schwarz (RAL 9005)**  
**Metrisches Anschlussgewinde nach EN 60423**  
**Schutzart IP 68 bis 10 bar, Type 4X**  
**Zugentlastung bis Klasse A, EN 62444**

*Polycarbonate, colours: grey (RAL 7035), black (RAL 9005)*  
*Metric connection thread according to EN 60423*  
*Type of protection IP 68 up to 10 bar, Type 4X*  
*Strain relief up to class A, EN 62444*

**i Schutzart IP 68/Type 4X ausschließlich in Verbindung mit separat erhältlicher Flachdichtung auf Seite 407**  
*Type of protection IP 68/Type 4X only in combination with separately available flat gasket on page 407*

Werkstoff Verschraubungskörper Material gland body	Ausführung/Farbe Version/colour	Bestellschlüssel Art. no. supplement	Werkstoff Dichteinsatz Material sealing insert	Farbe Colour	Bestellschlüssel Art. no. supplement	Temperaturbereich min./max. Temperature range (min./max.)
PC	Grau Grey		TPE	s. FC See CC		-20 °C / +100 °C
PC	Grau Grey		TPE-V	Natur Natural	p	-20 °C / +100 °C
PC	Grau Grey		Silikon HT Silicone HT	Schwarz Black	H	-20 °C / +100 °C
PC	Schwarz Black	n	TPE	s. FC See CC		-20 °C / +100 °C
PC	Schwarz Black	n	TPE-V	Natur Natural	p	-20 °C / +100 °C
PC	Schwarz Black	n	Silikon HT Silicone HT	Schwarz Black	H	-20 °C / +100 °C



Abb. 3  
Fig. 3

Anschlussgewinde/-länge Connection thread/length		Art.-Nr. Art. no.	Dichtbereich Sealing range	Bauhöhe Mounting height	Schlüsselweite Spanner width	
Ausführung bitte ergänzen Please indicate product details						
<b>A</b>	<b>D</b> mm	Grau/Grey = p Schwarz/Black = n	= TPE = TPE-V = Silikon HT/Silicone HT	<b>max./min. ø</b> mm	<b>C</b> mm	<b>SW<sub>1</sub> x E<sub>1</sub>/SW<sub>2</sub> x E<sub>2</sub></b> mm
M12x1,5	8,0	21249PC	7 *	6,5 – 4,0	23,0	15x16,5 50
M16x1,5	9,0	21650PC	7	6,5 – 4,0	22,0	19x21,2 50
		21650PC	8	8,0 – 5,0	22,0	19x21,2 50
		21650PC	9	9,5 – 6,5	22,0	19x21,2 50
M20x1,5	9,0	22051PC	7	6,5 – 4,0	23,0	24x26,5/22x24,4 50
		22051PC	8	8,0 – 5,0	23,0	24x26,5/22x24,4 50
		22051PC	9	9,5 – 6,5	23,0	24x26,5/22x24,4 50
		22051PC	11	10,5 – 7,0	23,0	24x26,5/22x24,4 50
		22052PC	7 *	6,5 – 4,0	23,0	24x26,5 50
		22052PC	8 *	8,0 – 5,0	23,0	24x26,5 50
		22052PC	9 *	9,5 – 6,5	23,0	24x26,5 50
		22052PC	11 *	10,5 – 7,0	23,0	24x26,5 50
M25x1,5	9,0	22553PC	7	6,5 – 4,0	24,0	30x33,5/27x29,5 50
		22553PC	8	8,0 – 5,0	24,0	30x33,5/27x29,5 50
		22553PC	9	9,5 – 6,5	24,0	30x33,5/27x29,5 50
		22553PC	11	10,5 – 7,0	24,0	30x33,5/27x29,5 50
		22553PC	13	13,0 – 9,0	24,0	30x33,5/27x29,5 50
		22553PC	16	15,5 – 11,5	24,0	30x33,5/27x29,5 50
M32x1,5	11,0	23254PC	11	10,5 – 7,0	29,0	36x39,5/33x36,5 25
		23254PC	13	13,0 – 9,0	29,0	36x39,5/33x36,5 25
		23254PC	16	15,5 – 11,5	29,0	36x39,5/33x36,5 25
		23254PC	18	18,0 – 14,0	29,0	36x39,5/33x36,5 25
		23254PC	20	20,5 – 17,0	29,0	36x39,5/33x36,5 25
M40x1,5	11,5	24055PC	16	15,5 – 11,5	33,0	46x50/43x46,5 10
		24055PC	18	18,0 – 14,0	33,0	46x50/43x46,5 10
		24055PC	20	20,5 – 17,0	33,0	46x50/43x46,5 10
		24055PC	25	25,0 – 20,0	33,0	46x50/43x46,5 10
		24055PC	28	28,0 – 24,0	33,0	46x50/43x46,5 10
M50x1,5	14,0	25056PC	32	32,0 – 27,0	34,0	56x61/53x57 5
		25056PC	34	34,0 – 29,0	34,0	56x61/53x57 5
		25056PC	36	36,0 – 32,0	34,0	56x61/53x57 5

\* Dichteinsatz kurz = Art.-Nr. Ek...  
 \* Sealing insert short = Art. no. Ek...

**i Passende Gegenmuttern ab Seite 384**  
 For matching lock nuts, see from page 384

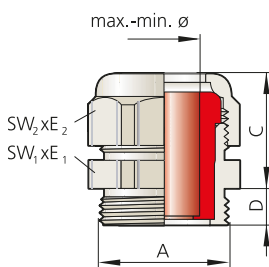
Technische Details und Informationen zu Zulassungen ab Seite 419  
 For technical details and information on certifications, see page 419 ff.

**UNI Dicht Kabelverschraubung**

UNI Dicht cable gland



Abb. 1  
Fig. 1



Abb. 2  
Fig. 2

**PVDF, Farben: Transparent, Blau (RAL 5015), Schwarz (RAL 9005)**  
**Metrisches Anschlussgewinde nach EN 60423**  
**Schutzart IP 68 bis 10 bar**  
**Zugentlastung bis Klasse A, EN 62444**

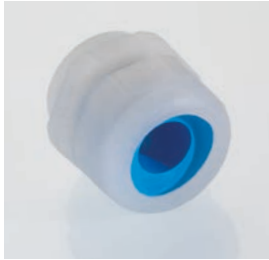
*PVDF, colours: transparent, blue (RAL 5015), black (RAL 9005)*  
*Metric connection thread according to EN 60423*  
*Type of protection IP 68 up to 10 bar*  
*Strain relief up to class A, EN 62444*

<b>i</b>	<b>Gewinde-Varianten:</b>	<b>Standard-Maß D</b>	<b>= Art.-Nr. 22052...</b>
	Thread variants:	<b>15 mm Länge</b> Standard size D 15 mm length	<b>= Art.-Nr. 82052...</b> = Art. no. 22052... = Art. no. 82052...

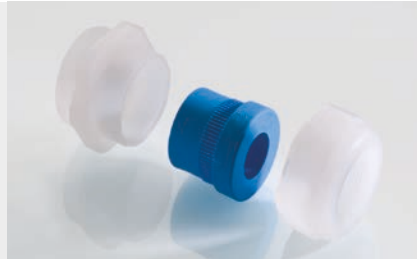
Werkstoff Verschraubungskörper Material gland body	Ausführung/Farbe Version/colour	Bestellschlüssel Art. no. supplement	Werkstoff Dichteinsatz Material sealing insert	Farbe Colour	Bestellschlüssel Art. no. supplement	Temperaturbereich min./max. Temperature range (min./max.)
PVDF	Transparent		TPE	s. FC See CC		-40 °C / +130 °C
PVDF	Transparent		TPE-V	Natur Natural	p	-40 °C / +135 °C
PVDF	Transparent		Silikon HT Silicone HT	Schwarz Black	H	-40 °C / +150 °C
PVDF	Blau Blue	a	TPE	s. FC See CC		-40 °C / +130 °C
PVDF	Blau Blue	a	TPE-V	Natur Natural	p	-40 °C / +135 °C
PVDF	Blau Blue	a	Silikon HT Silicone HT	Schwarz Black	H	-40 °C / +150 °C
PVDF	Schwarz Black	n	TPE	s. FC See CC		-40 °C / +130 °C
PVDF	Schwarz Black	n	TPE-V	Natur Natural	p	-40 °C / +135 °C
PVDF	Schwarz Black	n	Silikon HT Silicone HT	Schwarz Black	H	-40 °C / +150 °C



Abb. 3  
Fig. 3



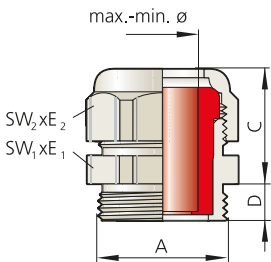

Abb. 4 – Ausführung lang, D = 15 mm  
 Fig. 4 – Long version, D = 15 mm

Anschlussgewinde/-länge Connection thread/length	Art.-Nr. Art. no.	Dichtbereich Sealing range	Bauhöhe Mounting height	Schlüsselweite Spanner width
Ausführung bitte ergänzen Please indicate product details				
<b>A</b>	<b>D</b> mm	Transparent = a Blau/Blue = a p Schwarz/Black = n	<b>max./min. ø</b> mm	<b>C</b> mm
		= TPE = TPE-V = Silikon HT/Silicone HT		<b>SW<sub>1</sub> x E<sub>1</sub>/SW<sub>2</sub> x E<sub>2</sub></b> mm 
M12x1,5	8,0	21249y 7 *	6,5– 4,0	23,0
M16x1,5	9,0	21650y 7	6,5– 4,0	24,0
		21650y 8	8,0– 5,0	24,0
		21650y 9	9,5– 6,5	24,0
M20x1,5	9,0	22051y 7	6,5– 4,0	23,0
		22051y 8	8,0– 5,0	23,0
		22051y 9	9,5– 6,5	23,0
		22051y 11	10,5– 7,0	23,0
		22052y 7 *	6,5– 4,0	25,0
		22052y 8 *	8,0– 5,0	25,0
		22052y 9 *	9,5– 6,5	25,0
		22052y 11 *	10,5– 7,0	25,0
		22052y 13 *	13,0– 9,0	25,0
M25x1,5	9,0	22553y 7	6,5– 4,0	26,0
		22553y 8	8,0– 5,0	26,0
		22553y 9	9,5– 6,5	26,0
		22553y 11	10,5– 7,0	26,0
		22553y 13	13,0– 9,0	26,0
		22553y 16	15,5– 11,5	26,0
M32x1,5	11,0	23254y 11	10,5– 7,0	29,0
		23254y 13	13,0– 9,0	29,0
		23254y 16	15,5– 11,5	29,0
		23254y 18	18,0– 14,0	29,0
		23254y 20	20,5– 17,0	29,0

\* Dichteinsatz kurz = Art.-Nr. Ek...  
 \* Sealing insert short = Art. no. Ek...

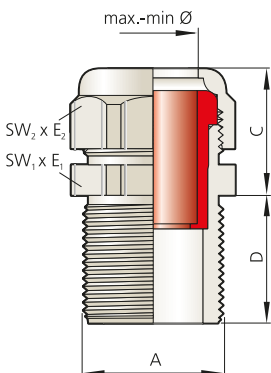
## UNI Dicht Kabelverschraubung

UNI Dicht cable gland

Fortsetzung von vorheriger Seite  
Continued from previous page

Anschlussgewinde/-länge Connection thread/length		Art.-Nr. Art. no.	Dichtbereich Sealing range	Bauhöhe Mounting height	Schlüsselweite Spanner width	
		Ausführung bitte ergänzen Please indicate product details				
A	D mm	Transparent =	= TPE	max./min. ø mm	C mm	SW <sub>1</sub> x E <sub>1</sub> /SW <sub>2</sub> x E <sub>2</sub> mm
		Blau/Blue = a	p = TPE-V			
		Schwarz/Black = n	H = Silikon HT/Silicone HT			
M40x1,5	11,5	24055y	16	15,5 – 11,5	34,0	46x50/43x46
		24055y	18	18,0 – 14,0	34,0	46x50/43x46
		24055y	20	20,5 – 17,0	34,0	46x50/43x46
		24055y	25	25,0 – 20,0	34,0	46x50/43x46
		24055y	28	28,0 – 24,0	34,0	46x50/43x46
M50x1,5	13,0	25056y	32	32,0 – 27,0	35,0	56x61/53x57
		25056y	34	34,0 – 29,0	35,0	56x61/53x57
		25056y	36	36,0 – 32,0	35,0	56x61/53x57
M50x1,5	14,0	25057y	40 * * * * *	40,0 – 36,0	38,0	60x65
M63x1,5	14,0	26358y	44 * * * * *	44,0 – 39,0	41,0	68x73/65x70

\* Dichteinsatz kurz = Art.-Nr. Ek... \*\* Dichteinsatz aus Silikon HT nicht lieferbar. \*\*\* Werkstoff POM (Farbe Weiß), Temperaturbereich: -40 °C bis +110 °C.

\* Sealing insert short = Art. no. Ek... \*\* Silicone HT sealing insert not available. \*\*\* Material POM (white), temperature range: -40 °C up to +110 °C.

**i** Schutzart IP 68/IP 69 ausschließlich in Verbindung mit separat erhältlicher Flachdichtung auf Seite 407  
Type of protection IP 68/IP 69 only in combination with separately available flat gasket on page 407

12x000 | TT000500



**UNI Dicht Schottverschraubung**

UNI Dicht bulkhead gland



Abb. 1  
Fig. 1



Abb. 2  
Fig. 2

**Messing vernickelt**  
**Metrisches Anschlussgewinde nach EN 60423**  
**Sondergewindelänge: 50 mm (weitere auf Anfrage)**  
**Mit O-Ring aus HNBR, Schutzart IP 68 bis 10 bar**  
**Zugentlastung bis Klasse A, EN 62444**

*Brass, nickel-plated*  
*Metric connection thread according to EN 60423*  
*Special thread length: 50 mm (additional lengths available on request)*  
*With o-ring made of HNBR, type of protection IP 68 up to 10 bar*  
*Strain relief up to class A, EN 62444*

**i** **Passende Gegenmuttern ab Seite 384**  
*For matching lock nuts, see from page 384*

Werkstoff Verschraubungskörper Material gland body	Ausführung/Farbe Version/colour	Werkstoff Dichteinsatz Material sealing insert	Farbe Colour	Bestellschlüssel Art. no. supplement	Temperaturbereich min./max. Temperature range (min./max.)
Messing Brass	Vernickelt Nickel-plated	TPE	s. FC See CC		-40 °C / +130 °C
Messing Brass	Vernickelt Nickel-plated	TPE-V	Natur Natural	p	-40 °C / +135 °C
Messing Brass	Vernickelt Nickel-plated	Silikon HT Silicone HT	Schwarz Black	H	-55 °C / +200 °C



Abb. 3  
Fig. 3

Anschlussgewinde/-länge Connection thread/length		Art.-Nr. Art. no.	Dichtbereich Sealing range	Bauhöhe Mounting height	Schlüsselweite Spanner width		
		Ausführung bitte ergänzen Please indicate product details					
		TPE =					
		TPE-V = p					
		Silikon HT/Silicone HT = H					
A	D mm		max./min. ø mm	C mm	SW <sub>1</sub> x E <sub>1</sub> /SW <sub>2</sub> x E <sub>2</sub> mm		
M20x1,5	50,0	22052d	7/50lg	6,5 – 4,0	21,0	22x24,4	10
		22052d	8/50lg	8,0 – 5,0	21,0	22x24,4	50
		22052d	9/50lg	9,5 – 6,5	21,0	22x24,4	10
		22052d	11/50lg	10,5 – 7,0	21,0	22x24,4	10
		22052d	13/50lg	13,0 – 9,0	21,0	22x24,4	50
M25x1,5	50,0	22553d	7/50lg	6,5 – 4,0	21,0	28x31,2/24x26,7	10
		22553d	8/50lg	8,0 – 5,0	21,0	28x31,2/24x26,7	10
		22553d	9/50lg	9,5 – 6,5	21,0	28x31,2/24x26,7	10
		22553d	11/50lg	10,5 – 7,0	21,0	28x31,2/24x26,7	10
		22553d	13/50lg	13,0 – 9,0	21,0	28x31,2/24x26,7	10
		22553d	16/50lg	15,5 – 11,5	21,0	28x31,2/24x26,7	50
M32x1,5	50,0	23254d	11/50lg	10,5 – 7,0	26,0	35x38,5/30x33,5	5
		23254d	13/50lg	13,0 – 9,0	26,0	35x38,5/30x33,5	5
		23254d	16/50lg	15,5 – 11,5	26,0	35x38,5/30x33,5	5
		23254d	18/50lg	18,0 – 14,0	26,0	35x38,5/30x33,5	5
		23254d	20/50lg	20,5 – 17,0	26,0	35x38,5/30x33,5	5
M40x1,5	50,0	24055d	16/50lg	15,5 – 11,5	29,0	43x47,3/40x43,5	5
		24055d	18/50lg	18,0 – 14,0	29,0	43x47,3/40x43,5	5
		24055d	20/50lg	20,5 – 17,0	29,0	43x47,3/40x43,5	5
		24055d	25/50lg	25,0 – 20,0	29,0	43x47,3/40x43,5	5
		24055d	28/50lg	28,0 – 24,0	29,0	43x47,3/40x43,5	5

11600 IT09000

## **UNI Dicht Erweitert – metrisch**

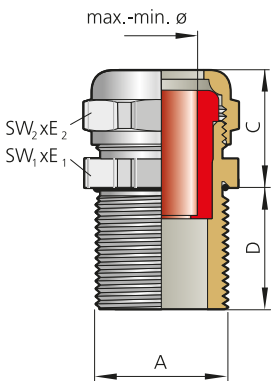
*UNI Dicht Extended – metric*



1

Abb. 1 – UNI Dicht Erweitert – Messing  
Fig. 1 – UNI Dicht Extended – brass

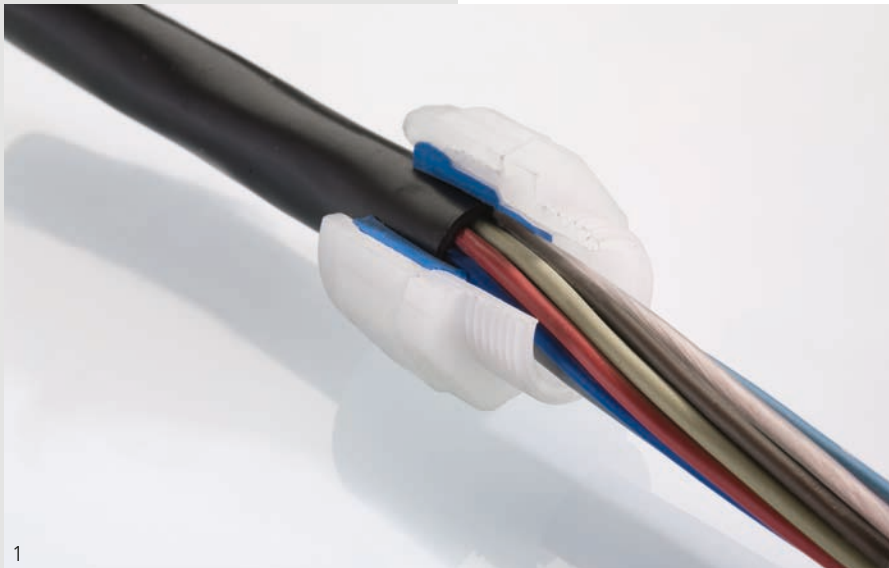

### Dicke Kabel durch kleine Bohrung

Sollen Kabel mit dickerem Durchmesser durch eine bestehende Bohrung geführt werden, lässt sich das mit sogenannten „erweiterten“ Doppelnippeln einfach realisieren. Diese verfügen über ein vergrößertes Kopfteil für die Aufnahme eines entsprechend kurzen Dichtensatzes. Das abgemantelte Kabel mit seinem deutlich kleineren Adernquerschnitt wird sicher durch den Anschlussbereich der Kabelverschraubung geführt.

### Thick cables through small holes

*If a thicker cable has to be fed through an existing hole, this can be done simply with an "extended" double nipple. This has an enlarged head to accept a correspondingly short sealing insert. The stripped cable with its significantly smaller diameter fits easily through the connection area of the cable gland.*



Abb. 1 – UNI Dicht Erweitert – PVDF  
Fig. 1 – UNI Dicht Extended – PVDF

Abb. 2 – UNI Dicht Erweitert – PVDF  
Fig. 2 – UNI Dicht Extended – PVDF

Abb. 3 – Querschnitt UNI Dicht Erweitert  
Fig. 3 – Cross section of the UNI Dicht Extended

**UNI Dicht Erweitert**

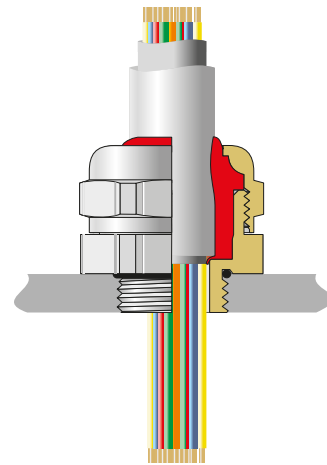
UNI Dicht Extended



Abb. 1  
Fig. 1



Abb. 2  
Fig. 2

**Messing vernickelt**  
**Metrisches Anschlussgewinde nach EN 60423**  
**Mit O-Ring aus HNBR**  
**Schutzart IP 68 bis 10 bar, Type 4X**  
**Zugentlastung bis Klasse A, EN 62444**

*Brass, nickel-plated*  
*Metric connection thread according to EN 60423*  
*With o-ring made of HNBR*  
*Type of protection IP 68 up to 10 bar, Type 4X*  
*Strain relief up to class A, EN 62444*

**i Achtung: für Dichteinsätze mit kurzer Bauform Art.-Nr. Ek... verwenden**  
*Note: For short sealing inserts, use Art. no. Ek...*

Werkstoff Verschraubungskörper <i>Material gland body</i>	Ausführung/Farbe <i>Version/colour</i>	Werkstoff Dichteinsatz <i>Material sealing insert</i>	Farbe <i>Colour</i>	Bestellschlüssel <i>Art. no. supplement</i>	Temperaturbereich min./max. <i>Temperature range (min./max.)</i>
Messing Brass	Vernickelt Nickel-plated	TPE	s. FC See CC		-40 °C / +130 °C
Messing Brass	Vernickelt Nickel-plated	TPE-V	Natur Natural	p	-40 °C / +135 °C
Messing Brass	Vernickelt Nickel-plated	Silikon HT Silicone HT	Schwarz Black	H	-55 °C / +200 °C



Abb. 3  
Fig. 3

Anschlussgewinde/-länge <i>Connection thread/length</i>	Art.-Nr. <i>Art. no.</i>	Dichtbereich <i>Sealing range</i>	Innendurchmesser <i>Inside diameter</i>	Durchlass Druckschraube max. <i>Opening pressure screw max.</i>	Bauhöhe <i>Mounting height</i>	Schlüsselweite <i>Spanner width</i>
Ausführung bitte ergänzen <i>Please indicate product details</i>						
<b>A</b>	TPE = TPE-V = p Silikon HT/Silicone HT = H	<b>max./min. ø</b> <b>mm</b>	<b>E</b> <b>mm</b>	<b>F</b> <b>mm</b>	<b>C</b> <b>mm</b>	<b>SW x E</b> <b>mm</b>
M12x1,5	21250d 21250d	8 9	8,0– 5,0 9,5– 6,5	7,5 7,5	10,0 10,0	21,0 17x18,9 50
M16x1,5	21651d 21652d	11 13	10,5– 7,0 13,0– 9,0	12,0 12,0	11,5 13,5	21,0 22x24,4 50
M20x1,5	22053d 22054d 22054d	16 18 20	15,5– 11,5 18,0– 14,0 20,5– 17,0	16,0 16,0 16,0	16,0 18,5 20,0	21,0 24,0 30x33,5 25
M25x1,5	22554d 22554d	18 20	18,0– 14,0 20,5– 17,0	20,5 20,5	18,5 21,0	26,0 30x33,5 25
M32x1,5	23255d 23255d 23256d 23256d 23256d	25 28 32 34 36	25,0– 20,0 28,0– 24,0 32,0– 27,0 34,0– 29,0 36,0– 32,0	26,5 26,5 26,0 26,0 26,0	29,0 29,0 38,0 38,0 38,0	29,0 40x43,5 10 28,0 50x54 5 28,0 50x54 5
M40x1,5	24056d 24056d 24056d	32 34 36	32,0– 27,0 34,0– 29,0 36,0– 32,0	34,5 34,5 34,5	38,0 38,0 38,0	28,0 50x54 10 28,0 50x54 10 28,0 50x54 10
M50x1,5	25057d 25057d	38 * 40 *	38,0– 34,0 40,0– 36,0	42,0 42,0	42,0 42,0	32,0 57x61 5 32,0 57x61 5

\* Dichteinsatz aus Silikon HT nicht lieferbar.  
\* Silicone HT sealing insert not available.

**i Passende Gegenmuttern ab Seite 384**  
*For matching lock nuts, see from page 384*

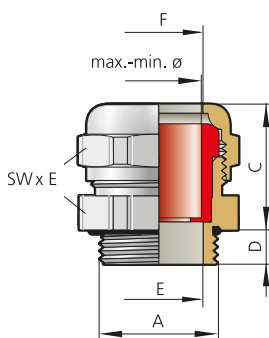
12100 | IT00430

**UNI Dicht Erweitert**

UNI Dicht Extended



Abb. 1  
Fig. 1



Abb. 2  
Fig. 2

**Edelstahl 1.4305**  
**Metrisches Anschlussgewinde nach EN 60423**  
**Mit O-Ring aus Silikon**  
**Schutzart IP 68 bis 10 bar, Type 4x**  
**Zugentlastung bis Klasse A, EN 62444**

*Stainless steel AISI 303*  
*Metric connection thread according to EN 60423*  
*With o-ring made of silicone*  
*Type of protection IP 68 up to 10 bar, Type 4x*  
*Strain relief up to class A, EN 62444*

**i Achtung: für Dichteinsätze mit kurzer Bauform Art.-Nr. Ek... verwenden**  
*Note: For short sealing inserts, use Art. no. Ek...*

Werkstoff Verschraubungskörper Material gland body	Ausführung/Farbe Version/colour	Werkstoff Dichteinsatz Material sealing insert	Farbe Colour	Bestellschlüssel Art. no. supplement	Temperaturbereich min./max. Temperature range (min./max.)
VA 1.4305 AISI 303	Blank	TPE-V	Natur Natural	P	-40 °C / +135 °C
VA 1.4305 AISI 303	Blank	Silikon HT Silicone HT	Schwarz Black	H	-55 °C / +200 °C



Abb. 3  
Fig. 3

Anschlussgewinde/-länge Connection thread/length	Art.-Nr. Art. no.	Dichtbereich Sealing range	Innendurchmesser Inside diameter	Durchlass Druckschraube max. Opening pressure screw max.	Bauhöhe Mounting height	Schlüsselweite Spanner width			
Ausführung bitte ergänzen Please indicate product details									
<b>A</b>	<b>D</b>	<b>TPE-V = p</b> <b>Silikon HT/Silicone HT = H</b>	<b>max./min. ø</b>	<b>E</b>	<b>F</b>	<b>C</b>			
<b>mm</b>	<b>mm</b>	<b>mm</b>	<b>mm</b>	<b>mm</b>	<b>mm</b>	<b>mm</b>			
M12x1,5	5,0	21250st	8	8,0– 5,0	7,5	10,0	19,5	17x18,9/0x0	50
		21250st	8	8,0– 5,0	7,5	10,0	19,5	17x18,9	50
		21250st	9	9,5– 6,5	7,5	10,0	19,5	17x18,9	50
		21250st	9	9,5– 6,5	7,5	10,0	19,5	17x18,9/0x0	50
M16x1,5	6,0	21651st	11	10,5– 7,0	12,0	11,5	20,0	22x24,4	50
		21651st	11	10,5– 7,0	12,0	11,5	20,0	22x24,4/0x0	50
M20x1,5	6,5	22053st	16	15,5– 11,5	16,0	16,2	20,0	24x26,7	50
		22053st	16	15,5– 11,5	16,0	16,2	20,0	24x26,7/0x0	50
		22054st	18	18,0– 14,0	16,0	18,5	25,0	30x33,5	25
		22054st	20	20,5– 17,0	16,0	21,0	25,0	30x33,5	25
M25x1,5	7,5	22554st	18	18,0– 14,0	20,5	18,5	25,0	30x33,5	25
		22554st	18	18,0– 14,0	20,5	18,5	25,0	30x33,5/0x0	25
		22554st	20	20,5– 17,0	20,5	21,0	25,0	30x33,5	25
M32x1,5	8,0	23255st	25	25,0– 20,0	26,5	29,0	25,0	41x43,5/41x44,5	10
		23255st	28	28,0– 24,0	26,5	29,0	25,0	41x43,5/41x44,5	10
		23256st	32	32,0– 26,0	26,0	38,0	28,0	50x54	10
		23256st	32	32,0– 27,0	26,0	38,0	28,0	50x54/0x0	10
		23256st	36	36,0– 32,0	26,0	38,0	28,0	50x54/0x0	10
M40x1,5	9,0	24056st	34	34,0– 29,0	34,5	38,0	28,0	50x54	10
		24056st	36	36,0– 32,0	34,5	38,0	28,0	50x54/0x0	10
M50x1,5	10,0	25057st	38	38,0– 34,0	42,0	42,0	32,0	60x65	5
		25057st	40	40,0– 36,0	42,0	42,0	32,0	60x65	5

**i Passende Gegenmuttern ab Seite 384**  
*For matching lock nuts, see from page 384*

**UNI Dicht Erweitert**

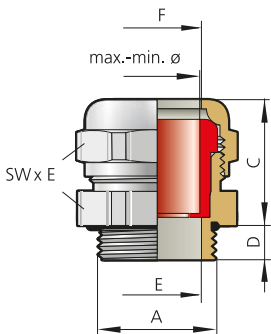
UNI Dicht Extended



Abb. 1  
Fig. 1

Abb. 2  
Fig. 2

**Polycarbonat, Farben: Grau (RAL 7035), Schwarz (RAL 9005)**  
**Metrisches Anschlussgewinde nach EN 60423**  
**Schutzart IP 68 bis 10 bar, Type 4X**  
**Zugentlastung bis Klasse A, EN 62444**

Polycarbonate, colours: grey (RAL 7035), black (RAL 9005)  
 Metric connection thread according to EN 60423  
 Type of protection IP 68 up to 10 bar, Type 4X  
 Strain relief up to class A, EN 62444

**i** **Achtung: für Dichteinsätze mit kurzer Bauform Art.-Nr. Ek... verwenden**  
 Note: For short sealing inserts, use Art. no. Ek...

Werkstoff Verschraubungskörper Material gland body	Ausführung/Farbe Version/colour	Bestellschlüssel Art. no. supplement	Werkstoff Dichteinsatz Material sealing insert	Farbe Colour	Bestellschlüssel Art. no. supplement	Temperaturbereich min./max. Temperature range (min./max.)
PC	Grau Grey		TPE	s. FC See CC		-20 °C / +100 °C
PC	Grau Grey		TPE-V	Natur Natural	p	-20 °C / +100 °C
PC	Grau Grey		Silikon HT Silicone HT	Schwarz Black	H	-20 °C / +100 °C
PC	Schwarz Black	n	TPE	s. FC See CC		-20 °C / +100 °C
PC	Schwarz Black	n	TPE-V	Natur Natural	p	-20 °C / +100 °C
PC	Schwarz Black	n	Silikon HT Silicone HT	Schwarz Black	H	-20 °C / +100 °C



Abb. 3  
Fig. 3

Anschlussgewinde/-länge Connection thread/length	Art.-Nr. Art. no.	Dichtbereich Sealing range	Innen-durchmesser Inside diameter	Durchlass Druckschraube max. Opening pressure screw max.	Bauhöhe Mounting height	Schlüsselweite Spanner width
Ausführung bitte ergänzen Please indicate product details						
<b>A</b>	<b>D</b>	Grau/Grey = p = TPE Schwarz/Black = n H = Silikon HT/Silicone HT	<b>max./min. ø</b>	<b>E</b>	<b>F</b>	<b>C</b>
	mm		mm	mm	mm	mm
M12x1,5	8,0	21250PC 21250PC	8 9	8,0 – 5,0 7,0	10,0 10,0	22,0 19x21,2
M16x1,5	8,5	21651PC 21652PC	11 13	10,5 – 7,0 11,5	11,0 13,5	23,0 24,0
M20x1,5	9,0	22053PC 22053PC	11 16	10,5 – 7,0 13,5	16,0 16,0	24,0 27x29,5
M25x1,5	11,0	22554PC 22554PC 22555PC 22555PC 22555PC	18 20 20 25 28	18,0 – 14,0 20,5 20,5 20,5 20,5	21,0 21,0 28,0 28,0 28,0	29,0 29,0 29,0 43x46 43x46
M32x1,5	11,0	23255PC 23255PC	25 28	25,0 – 20,0 25,0	28,0 28,0	32,0 43x46
M40x1,5	13,0	24056PC 24056PC 24056PC	32 34 36	32,0 – 27,0 34,5 34,5	37,0 37,0 37,0	35,0 53x57 53x57

**i** **Passende Gegenmuttern ab Seite 384**  
 For matching lock nuts, see from page 384

**i** **Schutzart IP 68/Type 4X ausschließlich in Verbindung mit separat erhältlicher Flachdichtung auf Seite 407**  
 Type of protection IP 68/Type 4X only in combination with separately available flat gasket on page 407

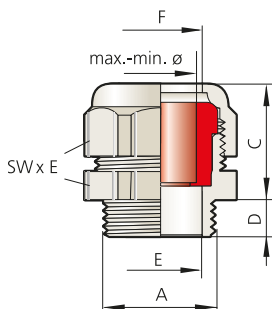
**UNI Dicht Erweitert**

UNI Dicht Extended



Abb. 1  
Fig. 1



Abb. 2  
Fig. 2

**PVDF, Farben: Transparent, Blau (RAL 5015), Schwarz (RAL 9005)**  
**Metrisches Anschlussgewinde nach EN 60423**  
**Schutzart IP 68 bis 10 bar**  
**Zugentlastung bis Klasse A, EN 62444**

*PVDF, colours: transparent, blue (RAL 5015), black (RAL 9005)*  
*Metric connection thread according to EN 60423*  
*Type of protection IP 68 up to 10 bar*  
*Strain relief up to class A, EN 62444*

**i Achtung: für Dichteinsätze mit kurzer Bauform Art.-Nr. Ek... verwenden**  
*Note: For short sealing inserts, use Art. no. Ek...*

Werkstoff Verschraubungskörper <i>Material gland body</i>	Ausführung/Farbe <i>Version/colour</i>	Bestellschlüssel <i>Art. no. supplement</i>	Werkstoff Dichteinsatz <i>Material sealing insert</i>	Farbe <i>Colour</i>	Bestellschlüssel <i>Art. no. supplement</i>	Temperaturbereich min./max. <i>Temperature range (min./max.)</i>
PVDF	Transparent		TPE	s. FC See CC		-40 °C / +130 °C
PVDF	Transparent		TPE-V	Natur Natural	p	-40 °C / +135 °C
PVDF	Transparent		Silikon HT Silicone HT	Schwarz Black	H	-40 °C / +150 °C
PVDF	Blau Blue	a	TPE	s. FC See CC		-40 °C / +130 °C
PVDF	Blau Blue	a	TPE-V	Natur Natural	p	-40 °C / +135 °C
PVDF	Blau Blue	a	Silikon HT Silicone HT	Schwarz Black	H	-40 °C / +150 °C
PVDF	Schwarz Black	n	TPE	s. FC See CC		-40 °C / +130 °C
PVDF	Schwarz Black	n	TPE-V	Natur Natural	p	-40 °C / +135 °C
PVDF	Schwarz Black	n	Silikon HT Silicone HT	Schwarz Black	H	-40 °C / +150 °C



Abb. 3  
Fig. 3

Anschlussgewinde/-länge <i>Connection thread/ length</i>	Art.-Nr. <i>Art. no.</i>	Dichtbereich <i>Sealing range</i>	Innen-durchmesser <i>Inside diameter</i>	Durchlass Druckschraube max. <i>Opening pressure screw height max.</i>	Bauhöhe <i>Mounting height</i>	Schlüsselweite <i>Spanner width</i>
Ausführung bitte ergänzen <i>Please indicate product details</i>						
	Transparent =					
	Blau/Blue = a	p	TPE-V			
	Schwarz/Black = n	H	Silikon HT/Silicone HT			
A	D mm	max./min. ø mm	E mm	F mm	C mm	SW x E mm
M16x1,5	8,5	9,5 – 6,5	11,5	11,0	23,0	22x24,5 50
M16x1,5	11,0	10,5 – 7,0	11,5	11,0	23,0	22x24,5 50
		13,0 – 9,0	11,5	13,0	25,0	24x26,5 50
M20x1,5	9,0	15,5 – 11,5	13,5	16,0	26,0	27x29,5 50
		15,5 – 11,5	15,5	21,0	29,0	33x36,5 25
M20x1,5	11,0	18,0 – 14,0	15,5	21,0	29,0	33x36,5 50
		20,5 – 17,0	15,5	21,0	29,0	33x36,5 50
		15,5 – 11,5	19,0	21,0	29,0	33x36,5 25
M25x1,5	11,0	18,0 – 14,0	19,0	21,0	29,0	33x36,5 25
		20,5 – 17,0	19,0	21,0	29,0	33x36,5 25
		18,0 – 14,0	20,5	28,0	33,0	43x46 25
		20,5 – 17,0	20,5	28,0	33,0	43x46 25
		25,0 – 20,0	20,5	28,0	33,0	43x46 25
M32x1,5	11,0	28,0 – 24,0	20,5	28,0	33,0	43x46 25
		25,0 – 20,0	25,0	28,0	33,0	43x46 10
M40x1,5	13,0	28,0 – 24,0	25,0	28,0	33,0	43x46 10
		32,0 – 27,0	34,5	37,0	35,0	53x57 5
		34,0 – 29,0	34,5	37,0	35,0	53x57 5
		36,0 – 32,0	34,5	37,0	35,0	53x57 5

**i Schutzart IP 68 ausschließlich in Verbindung mit separat erhältlicher Flachdichtung auf Seite 407**  
*Type of protection IP 68 only in combination with separately available flat gasket on page 407*

## UNI Mehrfach – metrisch

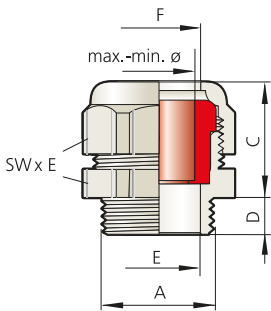
*UNI Multiple – metric*



Abb. 1 – UNI Mehrfach, montiert  
Fig. 1 – Assembled UNI Multiple

Abb. 2 – UNI Mehrfach und Verschlussbolzen für nicht belegte Löcher  
Fig. 2 – UNI Multiple and bolt for unused holes

Abb. 3 – UNI Mehrfach Dichteinsätze mit unterschiedlichen Lochbildern  
Fig. 3 – UNI Multiple sealing inserts with different hole patterns



### Mehrere Kabel sicher durch eine Bohrung führen

Wer aus Platz- oder Handlinggründen mehrere Kabel sicher durch eine Bohrung führen möchte, ersetzt den Standard-Dichteinsatz einfach durch Typen aus dem UNI Mehrfach Programm. Verschiedene Lochbilder stehen zur Verfügung, sodass sich auch unterschiedliche Kabeldurchmesser abdichten lassen. Dabei erreicht die UNI Mehrfach die Schutzart IP 65, wenn die Differenz von Kabeldurchmesser und Loch weniger als 10% beträgt. Sind beide gleich, lässt sich auch IP 68 (bis 10 bar) erreichen. Dichtigkeit und Zugentlastung sind abhängig vom verwendeten Kabel. Entsprechende Tests bietet PFLITSCH im eigenen Prüflabor an.

### Dichteinsätze nach Kundenwunsch

PFLITSCH fertigt diese Dichteinsätze exakt nach Kundenvorgabe aus dem hochwertigen Kunststoff TPE-V oder TPE. Dank dieser Fertigungsmethode kann PFLITSCH selbst Prototypen und Kleinserien zu wirtschaftlichen Preisen realisieren. Alternativ kann der Kunde geschlossene Dichteinsätze selbst mit Lochungen versehen. Nicht belegte Löcher werden mit einem Verschlussbolzen abgedichtet. Neben Lösungen mit runden Lochungen fertigt PFLITSCH auch Varianten für unterschiedliche Flachkabel und Kabel mit Sonderformen.

### Dichteinsätze für konfektionierte Kabel

Die Mehrfach-Dichteinsätze gibt es auch geteilt, z. B. für die Abdichtung von Kabeln, die bereits mit Steckern oder Sensoren konfektionierte sind. Diese Bauteile werden durch den Verschraubungskörper geführt, bevor die Kabel von den zwei Hälften des Dichteinsatzes zuverlässig umschlossen werden.

Für den gleichen Anwendungsfall bieten sich die seitlich geschlitzten Dichteinsätze an: Durch den nach außen offenen Schlitz lassen sich Kabel unkompliziert einführen.

### Feeding multiple cables safely through a single hole

Users wishing to feed multiple cables safely through a single hole for space reasons or for easier handling can replace the standard sealing insert with types from the UNI Multiple range. A number of hole patterns are available, so that a variety of cable diameters can be sealed. UNI Multiple fulfils type of protection IP 65 provided the difference between the cable and hole diameters is less than 10%. Should the values be the same, IP 68 (up to 10 bar) can be achieved. The tightness and strain relief depend on the cable used. PFLITSCH can conduct tests for this purpose in its own test laboratory.

### Customised sealing inserts

PFLITSCH manufactures these sealing inserts exactly to customer specifications from high-quality TPE-V or TPE plastic. This production method also enables PFLITSCH to make prototypes and small batches at affordable prices. Alternatively, customers can drill their own holes in closed sealing inserts. Unused holes are sealed with a bolt. In addition to solutions with round holes, PFLITSCH also offers variants for several different flat cables and cables with special shapes.

### Sealing inserts for pre-assembled cables

PFLITSCH can also supply split multiple sealing inserts, e.g. for sealing cables that are already pre-assembled with connectors or sensors. These components are fed through the gland body and the cables then reliably enclosed by the two halves of the sealing insert.

The laterally slit sealing inserts also lend themselves to this application: the slit is open to the outside, so that cables can simply be fed in.



PFLITSCH Mehrfach-Kabelverschraubungen



PFLITSCH multiple cable glands



Abb. 1 – Geteilter Mehrfach-Dichteinsatz  
Fig. 1 – Split multiple sealing insert

Abb. 2 – Kabelverschraubung für zwei ASI-Bus-Kabel  
Fig. 2 – Cable gland for two ASI bus cables

**UNI Mehrfach Kabelverschraubung**

UNI Multiple cable gland



Abb. 1  
Fig. 1



Abb. 2  
Fig. 2

**Messing vernickelt, Edelstahl 1.4305, Polycarbonat, PVDF**  
**Metrisches Anschlussgewinde nach EN 60423**  
**Schutzart IP 65**  
**Schutzart IP 68 bis 10 bar, wenn Kabel- $\phi$  = Loch- $\phi$ , Type 4X**  
**Zugentlastung bis Klasse A, EN 62444**

*Brass, nickel-plated, stainless steel AISI 303, polycarbonate, PVDF*  
*Metric connection thread according to EN 60423*

*Type of protection IP 65*

*Type of protection IP 68 up to 10 bar, achievable if cable  $\phi$  = hole  $\phi$ , Type 4X*  
*Strain relief up to class A, EN 62444*

Werkstoff Verschraubungskörper Material gland body	Ausführung/Farbe Version/colour	Bestellschlüssel Art. no. supplement	Werkstoff Dichteinsatz Material sealing insert	Farbe Colour	Bestellschlüssel Art. no. supplement	Temperaturbereich min./max. Temperature range (min./max.)
Messing Brass	Vernickelt Nickel-plated	d	TPE	Weiß White		-40 °C / +130 °C
Messing Brass	Vernickelt Nickel-plated	d	TPE-V	Natur Natural	p	-40 °C / +135 °C
VA 1.4305 AISI 303	Blank	st	TPE	Weiß White		-40 °C / +130 °C
VA 1.4305 AISI 303	Blank	st	TPE-V	Natur Natural	p	-40 °C / +135 °C
PC	Grau Grey	PC	TPE	Weiß White		-20 °C / +100 °C
PC	Grau Grey	PC	TPE-V	Natur Natural	p	-20 °C / +100 °C
PVDF	Transparent	y	TPE	Weiß White		-40 °C / +130 °C
PVDF	Transparent	y	TPE-V	Natur Natural	p	-40 °C / +135 °C



Abb. 3 – Beispiel „2 x 3“  
 2 = Anzahl Bohrungen  
 3 = Bohrungsdurchmesser in mm  
 Fig. 3 – Example “2 x 3”  
 2 = Number of holes  
 3 = Hole diameter in mm

Anschlussgewinde Connection thread	Art.-Nr. Art. no.	Ausführung bitte ergänzen Please indicate product details	
<b>A</b>		Messing/Brass = d	
		VA 1.4305/AISI 303 = st	
		PC = PC	= TPE
		PVDF = y	p = TPE-V
M6x0,8	206	m2x1 *	50
M10x1,0	21049	m1x3/1mm *	50
	21049	m1x4/1mm *	50
	21049	m1x5/1mm *	50
M10x1,5	21049	m1x3/1,5mm *	50
	21049	m1x4/1,5mm *	50
	21049	m1x5/1,5mm *	50
M12x1,5	21249	m1x3	50
	21249	m1x4	50
	21249	m1x5	50
	21250	m1x5 **	50
	21250	m2x3 **	50
	21250	m2x4 **	50
M16x1,5	21250	m3x3 **	50
	21650	m1x1,5S/1x4	50
	21650	m1x3	50
	21650	m1x4	50
	21650	m1x5	50
	21650	m2x1,2 **	50
	21650	m2x3	50
	21650	m2x3,3	50
	21650	m2x4	50
	21650	m3x3	50
21650	m3x3,5	50	
21650	m4x1,4 **	50	

\* Variante in y und PC nicht erhältlich. \*\* Dichteinsatz kurz = Art.-Nr. Ek...  
 \* Variant y and PC not available. \*\* Sealing insert short = Art. no. Ek...

Technische Details und Informationen zu Zulassungen ab Seite 419  
 For technical details and information on certifications, see page 419 ff.

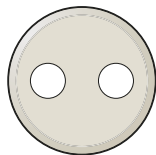
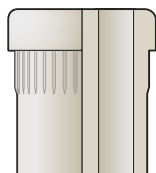
Fortsetzung auf der nächsten Seite  
 Continued on next page

## UNI Mehrfach Kabelverschraubung

UNI Multiple cable gland

Fortsetzung von vorheriger Seite  
Continued from previous page

Anschlussgewinde Connection thread	Art.-Nr. Art. no.	Ausführung bitte ergänzen Please indicate product details		
A M16x1,5	Messing/Brass	= d		
	VA 1.4305/AISI 303	= st		
	PC	= PC	= TPE	
	PVDF	= y	p = TPE-V	
	21650	m4x2		50
	21650	m4x3		50
	21650	m4x3,3		50
	21650	m5x1,4 *		50
	21651	m1x2/2x4 *		50
	21651	m2x3/1x5 *		50
	21651	m6x2 *		50
	21652	m1x4,7/1x6,4 *		50
	21652	m2x3 *		50
	21652	m2x4 *		50
	21652	m2x5 *		50
M20x1,5	22051	m1x3		50
	22051	m1x3/1x6		50
	22051	m1x4		50
	22051	m1x5		50
	22051	m2x2,3		50
	22051	m2x3		50
	22051	m2x4		50
	22051	m3x1,5		50
	22051	m3x3		50
	22051	m3x4		50
	22051	m4x1,5 *		50
	22051	m4x2,5/1x3,5		50
	22051	m5x2,5		50
	22051	m6x2		50
	22051	m6x2,5		50
	22051	m7x1,5 *		50
	22051	m9x1,5 *		50
	22052	m1x2/3x3 **		50
	22052	m1x2,5 **		50
	22052	m1x3 **		50
	22052	m1x3,5/1x6 **		50
	22052	m1x3,5/2x4,5 **		50
	22052	m1x4 **		50
	22052	m1x4,7/1x6,4 **		50
	22052	m1x5 **		50
	22052	m1x5,5/1x6 ** ***		50
	22052	m1x8S **		50
	22052	m2x3 **		50
	22052	m2x4 ** ***		50
	22052	m2x4/1x5,5 **		50

Anschlussgewinde Connection thread	Art.-Nr. Art. no.	Ausführung bitte ergänzen Please indicate product details		
A M20x1,5	Messing/Brass	= d		
	VA 1.4305/AISI 303	= st		
	PC	= PC	= TPE	
	PVDF	= y	p = TPE-V	
	22052	m2x4,5 **		50
	22052	m2x5 **		50
	22052	m3x1,9/1x6 * **		50
	22052	m3x2 * **		50
	22052	m3x3 **		50
	22052	m3x3/1x6 **		50
	22052	m3x4 **		50
	22052	m4x3 **		50
	22052	m4x4 **		50
	22052	m5x2 * **		50
	22052	m6x2,5 **		50
M25x1,5	22052	m6x3,5 **		50
	22052	m7x3,3 **		50
	22052	m8x1,5 * **		50
	22052	m8x2 * **		50
	22052	m8x3 * ** ***		50
	22052	m10x2 * **		50
	22053	m1x3/1x6/1x8 *		50
	22053	m1x5/1x9 *		50
	22053	m1x6/1x8 *		50
	22053	m2x3,2/2x6 *		50
	22053	m2x3,5 *		50
	22053	m2x4 *		50
	22053	m2x5 *		50
	22053	m2x5,3/1x6,3 *		50
	22053	m2x6 *		50
22053	m2x6/1x7 *		50	
22053	m2x6,5 *		50	
22053	m2x7 *		50	
22053	m3x5/1x8 *		50	
22053	m3x6 *		50	
22053	m4x5 *		50	
22053	m4x6 *		50	
22053	m6x4 *		50	
22053	m18x2,4 *		50	
22553	m1x2,6		50	
22553	m1x3/1x8		50	
22553	m1x3/1x9		50	
22553	m1x3,3/2x3,7		50	
22553	m1x3,5		50	
22553	m1x4		50	
22553	m1x4/1x5		50	
22553	m1x4/2x6/1x7		50	
22553	m1x4/3x5		50	
22553	m1x5		50	

20400 | ITD 1900

\* Dichteinsatz kurz = Art.-Nr. Ek... \*\* Bei Variante y und PC Dichteinsatz kurz = Art.-Nr. Ek... \*\*\* Variante in d und st nicht erhältlich.  
\* Sealing insert short = Art. no. Ek... \*\* Variant y and PC sealing insert short = Art. no. Ek... \*\*\* Variant in d and st not available.

Technische Details und Informationen zu Zulassungen ab Seite 419  
For technical details and information on certifications, see page 419 ff.

Fortsetzung auf der nächsten Seite  
Continued on next page

## UNI Mehrfach Kabelverschraubung

UNI Multiple cable gland

Fortsetzung von vorheriger Seite  
Continued from previous page

Anschlussgewinde		Art.-Nr.	
Connection thread		Art. no.	
Ausführung bitte ergänzen Please indicate product details			
	Messing/Brass	= d	
	VA 1.4305/AISI 303	= st	
A	PC	= PC	= TPE
	PVDF	= y	p = TPE-V
M25x1,5	22553	m1x5/1x9	50
	22553	m1x5/2x6	50
	22553	m1x6/1x8	50
	22553	m1x6,3/1x6,6	50
	22553	m1x8S	50
	22553	m2x3,2/2x6	50
	22553	m2x3,3	50
	22553	m2x3,5	50
	22553	m2x3,5/1x5,5	50
	22553	m2x3,5/1x8,5	50
	22553	m2x4	50
	22553	m2x5	50
	22553	m2x5/1x6	50
	22553	m2x6	50
	22553	m2x6/1x7	50
	22553	m2x6/1x8	50
	22553	m2x7	50
	22553	m3x1,9/1x2,4/1x7 *	50
	22553	m3x2,5/1x3,5/1x7	50
	22553	m3x3	50
	22553	m3x3/1x6	50
	22553	m3x3,5	50
	22553	m3x4/1x9	50
	22553	m3x5/1x8	50
	22553	m3x6	50
	22553	m4x3	50
	22553	m4x4	50
	22553	m4x5	50
	22553	m4x6	50
	22553	m6x4	50
	22553	m7x2 *	50
	22553	m7x3	50
	22553	m9x3	50
	22553	m13x2,7	50
	22554	m1x4/1x12 *	25
	22554	m1x4,5/1x12 *	25
	22554	m1x4,5/2x6,5 *	25
	22554	m1x5/1x11,2 *	25
	22554	m1x5,5/1x9 *	25
	22554	m1x5,5/1x10,5 *	25
	22554	m1x5,8/1x6,9/1x8,4 *	25
	22554	m1x6/2x9 *	25
	22554	m1x6,5/1x12 *	25
	22554	m1x6,9/1x7,4/1x8,4 *	25
	22554	m1x7/1x8,5 *	25
	22554	m1x7/1x10,5 *	25

Anschlussgewinde		Art.-Nr.	
Connection thread		Art. no.	
Ausführung bitte ergänzen Please indicate product details			
	Messing/Brass	= d	
	VA 1.4305/AISI 303	= st	
A	PC	= PC	= TPE
	PVDF	= y	p = TPE-V
M25x1,5	22554	m1x7,5/1x8,5/1x10 *	25
	22554	m1x8 *	25
	22554	m1x11,8 *	25
	22554	m2x5/1x5,5 *	25
	22554	m2x6 *	25
	22554	m2x6/2x8 *	25
	22554	m2x6,5/1x9,5 *	25
	22554	m2x7 *	25
	22554	m2x8 *	25
	22554	m2x9 *	25
	22554	m3x2,5/3x8 *	25
	22554	m3x5 *	25
	22554	m3x7 *	25
	22554	m3x8 *	25
	22554	m3x9 *	25
	22554	m4x4,6/3x5,1 *	25
	22554	m4x5 *	25
	22554	m4x5/1x6,5 *	25
	22554	m4x6 *	25
	22554	m4x6,5 *	25
	22554	m4x7,5 *	25
	22554	m4x8 *	25
	22554	m5x5 *	25
	22554	m5x6 *	25
	22554	m6x4 *	25
	22554	m6x5 *	25
	22554	m6x5,5 *	25
	22554	m7x4 *	25
	22554	m8x3 *	25
	22554	m8x4 *	25
	22554	m8x5 *	25
	22554	m8x5,5 *	25
	22554	m12x3,5 *	25
	22555	m1x10/1x12 ***	25
M32x1,5	23254	m1x3,2/2x5/1x6S	25
	23254	m1x3,2/2x6/1x6,1/1x6,8/1x7,3	25
	23254	m1x3,2/2x6/3x7	25
	23254	m1x3,2S/2x5S/1x8,5S	25
	23254	m1x4/1x5/1x13	25
	23254	m1x4,3/1x6/1x8	25
	23254	m1x4,5/1x6/2x6,5	25
	23254	m1x4,5/2x7/1x8	25
	23254	m1x4,5/2x8	25
	23254	m1x4,5/3x7,5	25
	23254	m1x5/1x7/1x12	25
	23254	m1x5/1x9	25

\* Dichteinsatz kurz = Art.-Nr. Ek... \*\* Ausführung in Edelstahl nicht lieferbar.  
\* Sealing insert short = Art. no. Ek... \*\* Version made of stainless steel not available.

Technische Details und Informationen zu Zulassungen ab Seite 419  
For technical details and information on certifications, see page 419 ff.

Fortsetzung auf der nächsten Seite  
Continued on next page

## UNI Mehrfach Kabelverschraubung

UNI Multiple cable gland

Fortsetzung von vorheriger Seite  
Continued from previous page

Anschlussgewinde Connection thread	Art.-Nr. Art. no.	Ausführung bitte ergänzen Please indicate product details		
A		Messing/Brass = d		
		VA 1.4305/AISI 303 = st		
		PC = PC	= TPE	
		PVDF = y	p = TPE-V	
M32x1,5	23254	m1x5,7/1x13	25	
	23254	m1x5,7/2x6,3/1x8,5	25	
	23254	m1x6/2x9	25	
	23254	m1x6,5/1x12	25	
	23254	m1x7	25	
	23254	m1x7/1x8,5	25	
	23254	m1x7/1x10,5	25	
	23254	m1x9/1x10	25	
	23254	m2x3,1/1x6/2x7,7	25	
	23254	m2x4,5	25	
	23254	m2x4,5/1x13	25	
	23254	m2x5,6	25	
	23254	m2x6/2x8	25	
	23254	m2x7	25	
	23254	m2x7/3x7,5	25	
	23254	m2x7,2/1x10,5	25	
	23254	m2x8	25	
	23254	m2x9	25	
	23254	m3x3	25	
	23254	m3x4	25	
	23254	m3x5	25	
	23254	m3x6	25	
	23254	m3x6/1x8	25	
	23254	m3x6/2x8	25	
	23254	m3x7	25	
	23254	m3x8	25	
	23254	m3x9	25	
	23254	m4x5	25	
	23254	m4x5/4x5,5	25	
	23254	m4x6	25	
	23254	m4x6/1x8	25	
	23254	m4x6/3x6,5	25	
	23254	m4x6,5	25	
	23254	m4x6,5/1x6,5SB	25	
	23254	m4x8	25	
	23254	m5x4	25	
	23254	m5x5	25	
	23254	m5x6	25	
	23254	m6x4	25	
	23254	m6x4/1x7	25	
	23254	m6x5	25	
	23254	m6x5,5	25	
	23254	m8x3	25	
	23254	m8x4	25	
	23254	m8x4/1x4,5B	25	

Anschlussgewinde Connection thread	Art.-Nr. Art. no.	Ausführung bitte ergänzen Please indicate product details		
A		Messing/Brass = d		
		VA 1.4305/AISI 303 = st		
		PC = PC	= TPE	
		PVDF = y	p = TPE-V	
M32x1,5	23254	m8x5	25	
	23254	m8x5,5	25	
	23254	m9x3	25	
	23254	m21x2	25	
	23255	m1x3,5/2x8/1x14 *	10	
	23255	m1x4/1x6/1x8/2x10 *	10	
	23255	m1x4/1x9,3/1x10 *	10	
	23255	m1x4/2x8 *	10	
	23255	m1x5/3x8,5/1x10,5 *	10	
	23255	m1x5,8/1x6,9/1x11 *	10	
	23255	m1x5,8/2x11 *	10	
	23255	m1x6/1x8,5/1x10,5 *	10	
	23255	m1x6,5/1x17 *	10	
	23255	m1x6,5/2x11,2 *	10	
	23255	m1x7/1x9/1x11 *	10	
	23255	m1x7/1x16 *	10	
	23255	m1x7,2/1x9,1/1x9,3 *	10	
	23255	m1x8/1x14 *	10	
	23255	m1x8/1x9/1x12 *	10	
	23255	m1x8/2x11 *	10	
	23255	m1x9/1x10 *	10	
	23255	m1x9/1x10/1x11 *	10	
	23255	m1x9/1x15 *	10	
	23255	m1x10/1x12 *	10	
	23255	m1x10/1x13 *	10	
	23255	m1x10/1x15 *	10	
	23255	m1x10,5/1x16 *	10	
	23255	m1x11/2x12 *	10	
	23255	m2x5/1x8,6/1x12,2 *	10	
	23255	m2x5/2x9 *	10	
	23255	m2x5,8/1x11 *	10	
	23255	m2x6/2x10 *	10	
	23255	m2x8,5/1x13,5 *	10	
	23255	m2x11 *	10	
	23255	m2x12 *	10	
	23255	m2x13 *	10	
	23255	m3x7 *	10	
	23255	m3x9	10	
	23255	m3x9 *	10	
	23255	m3x11 *	10	
	23255	m4x5,5/1x8 *	10	
	23255	m4x6,5 *	10	
	23255	m4x8 *	10	
	23255	m4x9 *	10	
	23255	m4x10 *	10	

20400 | ITD 1900

\* Dichteinsatz kurz = Art.-Nr. Ek...  
\* Sealing insert short = Art. no. Ek...

Technische Details und Informationen zu Zulassungen ab Seite 419  
For technical details and information on certifications, see page 419 ff.

Fortsetzung auf der nächsten Seite  
Continued on next page

## UNI Mehrfach Kabelverschraubung

UNI Multiple cable gland

Fortsetzung von vorheriger Seite  
Continued from previous page

Anschlussgewinde		Art.-Nr.	
Connection thread		Art. no.	
Ausführung bitte ergänzen Please indicate product details			
	Messing/Brass	= d	
	VA 1.4305/AISI 303	= st	
A	PC	= PC	= TPE
	PVDF	= y p	= TPE-V
M32x1,5	23255	m4x11 *	10
	23255	m4x9S *	10
	23255	m5x8 *	10
	23255	m5x9 *	10
	23255	m5x9,5 *	10
	23255	m6x6 *	10
	23255	m6x7,5 *	10
	23255	m6x8 *	10
	23255	m7x7 *	10
	23255	m8x5,5 *	10
	23255	m10x6 *	10
	23255	m11x5,2 *	10
	23255	m12x2,8/2x5/2x8 *	10
	23255	m12x5,3 *	10
	23255	m24x3 *	10
M40x1,5	24055	m1x4/1x6/1x8/2x10	10
	24055	m1x4/2x6/4x8	10
	24055	m1x4/2x7/2x9	10
	24055	m1x4/7x7	10
	24055	m1x4,5/4x8	10
	24055	m1x5/2x9/1x13	10
	24055	m1x5/4x9	10
	24055	m1x5,5/1x9	10
	24055	m1x5,8/2x11	10
	24055	m1x6/1x10	10
	24055	m1x6/1x7/1x8/1x11	10
	24055	m1x6/1x8,5/1x10,5	10
	24055	m1x6/2x6,5/2x8	10
	24055	m1x6/2x8/2x11	10
	24055	m1x6/2x9	10
	24055	m1x6,5/1x17	10
	24055	m1x6,5/2x7,5	10
	24055	m1x25,5	10
	24055	m1x6SB/3x6/3x8/1x9,2	10
	24055	m1x7/1x14	10
	24055	m1x7/1x8,5/1x17	10
	24055	m1x7/1x9,5/1x12	10
	24055	m1x7/1x9/1x11	10
	24055	m1x7/2x8,5	10
	24055	m1x7/2x8/2x10	10
	24055	m1x7/3x9	10
	24055	m1x8/2x11	10
	24055	m1x8/2x12	10
	24055	m1x8/2x8,5/1x12	10
	24055	m1x8/2x8,5/1x15	10
	24055	m1x9/1x10/1x11	10

Anschlussgewinde		Art.-Nr.	
Connection thread		Art. no.	
Ausführung bitte ergänzen Please indicate product details			
	Messing/Brass	= d	
	VA 1.4305/AISI 303	= st	
A	PC	= PC	= TPE
	PVDF	= y p	= TPE-V
M40x1,5	24055	m1x9/1x15	10
	24055	m1x9,5/1x11,5/1x13,5	10
	24055	m1x10/1x11,5/1x13	10
	24055	m1x10/1x12/1x13,5	10
	24055	m1x10/1x13	10
	24055	m1x10,5/1x16	10
	24055	m1x10,7/1x13,8	10
	24055	m1x12/1x13	10
	24055	m2x4/2x5/2x7/2x8	10
	24055	m2x4,8/2x6,3	10
	24055	m2x4,8/5x6,3	10
	24055	m2x5/1x8,6/1x12,2	10
	24055	m2x5,8/1x11	10
	24055	m2x6/1x10,5/1x12	10
	24055	m2x6/1x7,5/2x8,5	10
	24055	m2x6/1x8,5	10
	24055	m2x6/1x8/2x10	10
	24055	m2x6/2x6S/1x7/1x7S/1x10	10
	24055	m2x6,5	10
	24055	m2x6,5/1x10,5	10
	24055	m2x7/1x9	10
	24055	m2x8,5/1x13,5	10
	24055	m2x8,5/2x11,5	10
	24055	m2x9	10
	24055	m2x9/1x13	10
	24055	m2x9/1x15	10
	24055	m2x10	10
	24055	m2x11	10
	24055	m2x13	10
	24055	m3x3/7x4/1x8	10
	24055	m3x3/8x5	10
24055	m3x3/8x5/1x8	10	
24055	m3x7	10	
24055	m3x7/3x8	10	
24055	m3x9	10	
24055	m3x9/1x11,5	10	
24055	m3x10	10	
24055	m3x11	10	
24055	m3x12	10	
24055	m4x3,5/2x7/1x11	10	
24055	m4x5	10	
24055	m4x5,5	10	
24055	m4x5,5/1x8	10	
24055	m4x5,7/2x10	10	
24055	m4x6/3x8,5	10	
24055	m4x6,5	10	

\* Dichteinsatz kurz = Art.-Nr. Ek...  
\* Sealing insert short = Art. no. Ek...

Technische Details und Informationen zu Zulassungen ab Seite 419  
For technical details and information on certifications, see page 419 ff.

Fortsetzung auf der nächsten Seite  
Continued on next page

## UNI Mehrfach Kabelverschraubung

UNI Multiple cable gland

Fortsetzung von vorheriger Seite  
Continued from previous page

Anschlussgewinde		Art.-Nr.	
Connection thread		Art. no.	
Ausführung bitte ergänzen Please indicate product details			
	Messing/Brass	= d	
	VA 1.4305/AISI 303	= st	
A	PC	= PC	= TPE
	PVDF	= y p	= TPE-V
M40x1,5	24055	m4x6,5/4x6,5SB	10
	24055	m4x8	10
	24055	m4x9	10
	24055	m4x10	10
	24055	m5x3,5/2x5/1x6/2x6,5	10
	24055	m5x8	10
	24055	m5x9	10
	24055	m6x4/3x6/1x8	10
	24055	m6x6	10
	24055	m6x8	10
	24055	m7x4,8	10
	24055	m7x5,5/2x6,5	10
	24055	m7x6/1x11	10
	24055	m7x7	10
	24055	m7x8	10
	24055	m8x5,5	10
	24055	m10x6	10
	24055	m12x2,8	10
	24055	m12x4/1x8	10
	24055	m12x5,3	10
	24055	m13x3,5/1x9,5	10
	24055	m16x3,5	10
	24055	m17x3,5	10
	24055	m20x3,5	10
	24055	m24x3	10
	24056	m1x4/1x5/2x13 *	5
	24056	m1x4/2x6/4x9 *	5
	24056	m1x4/5x10 *	5
	24056	m1x8,5/1x23	10
	24056	m1x13/1x19 *	10
	24056	m1x14/1x17 *	10
	24056	m2x14 *	10
	24056	m2x15 *	10
	24056	m3x7/4x10 *	10
	24056	m3x13	10
	24056	m3x14,5 *	10
	24056	m4x7 *	10
	24056	m4x10,2 *	10
	24056	m4x13 *	10
	24056	m7x9 *	10
	24056	m8x6/4x8 *	10
	24056	m8x8 *	10
	24056	m8x9 *	10
	24056	m12x6,4 *	10

Anschlussgewinde		Art.-Nr.	
Connection thread		Art. no.	
Ausführung bitte ergänzen Please indicate product details			
	Messing/Brass	= d	
	VA 1.4305/AISI 303	= st	
A	PC	= PC	= TPE
	PVDF	= y p	= TPE-V
M50x1,5	25056	m1x3,7/4x4,8/1x5,4/1x6,5/1x10	5
	25056	m1x5/1x9/1x11/1x19	5
	25056	m1x5/2x6,5/1x8,5/1x11	5
	25056	m1x5/3x8/1x8,5/1x9,5	5
	25056	m1x8/4x12,5	5
	25056	m1x9,5/2x13,5	5
	25056	m1x10/3x11,5	5
	25056	m1x11/1x21	5
	25056	m1x11/2x13	5
	25056	m1x12,5/1x16,5	5
	25056	m1x13/1x19	5
	25056	m1x13/2x16,5	5
	25056	m1x14/1x17	5
	25056	m1x20,5	5
	25056	m1x23	5
	25056	m1x26	5
	25056	m1x28	5
	25056	m1x55B/4x7/1x14	5
	25056	m2x8/3x10	5
	25056	m2x9	5
	25056	m2x15	5
	25056	m3x10	5
	25056	m3x14,5	5
	25056	m4x7	5
	25056	m4x9	5
	25056	m4x10,2	5
	25056	m4x11,5	5
	25056	m4x12	5
	25056	m4x13	5
	25056	m5x11,5	5
	25056	m6x10	5
	25056	m7x9	5
	25056	m8x7	5
	25056	m8x8	5
	25056	m8x9	5
	25056	m11x8	5
	25056	m13x7	5
	25056	m15x5	5
	25056	m16x6	5
	25057	m1x7,5/3x11/1x13 * **	5
	25057	m1x13,5/3x15,6 * **	5
	25057	m2x17 * **	5
	25057	m3x6,7/1x11/1x14,5 * **	5
	25057	m5x11 * **	5

\* Dichteinsatz kurz = Art.-Nr. Ek... \*\* Variante PC nicht lieferbar. Variante y aus Werkstoff POM (Farbe Weiß), Temperaturbereich: -40 °C bis +110 °C. Es besteht keine CSA-Zulassung.  
\* Sealing insert short = Art. no. Ek... \*\* Variant PC not available. Variant y made of POM (white), temperature range: -40 °C up to +110 °C, no CSA approval.

## UNI Mehrfach Kabelverschraubung

UNI Multiple cable gland

Fortsetzung von vorheriger Seite  
Continued from previous page

Anschlussgewinde		Art.-Nr.		Ausführung bitte ergänzen	
Connection thread		Art. no.		Please indicate product details	
		Messing/Brass	= d		
		VA 1.4305/AISI 303	= st	= TPE	
		PVDF	= y	p = TPE-V	
M63x1,5	26358	m1x5,5/1x9/2x15,5 *	5		
	26358	m1x5,5/4x15,5 *	5		
	26358	m1x9/1x11/3x15,5 *	5		
	26358	m1x11/1x32 *	5		
	26358	m1x13/3x17 *	5		
	26358	m1x30 *	5		
	26358	m1x35 *	5		
	26358	m2x4,5/2x21 *	5		
	26358	m2x11/2x17 *	5		
	26358	m2x15 *	5		
	26358	m2x16 *	5		
	26358	m3x12,5 *	5		

Anschlussgewinde		Art.-Nr.		Ausführung bitte ergänzen	
Connection thread		Art. no.		Please indicate product details	
		Messing/Brass	= d		
		VA 1.4305/AISI 303	= st	= TPE	
		PVDF	= y	p = TPE-V	
M63x1,5	26358	m3x13,5 *	5		
	26358	m3x14,5 *	5		
	26358	m3x18 *	5		
	26358	m4x12 *	5		
	26358	m4x16 *	5		
	26358	m5x13 *	5		
	26358	m6x5,1/1x10/1x10,5/2x13 *	5		
	26358	m8x10 *	5		
	26358	m8x12 *	5		
	26358	m13x3,5/9x5,2 *	5		
	26358	m18x7 *	5		
	26358	m23x3,3/4x5,1 *	5		

\* Variante PC nicht lieferbar. Variante y aus Werkstoff POM (Farbe Weiß), Temperaturbereich: -40 °C bis +110 °C. Es besteht keine CSA-Zulassung.

\* Variant PC not available. Variant y made of POM (white), temperature range: -40 °C up to +110 °C, no CSA approval.

**i** VDE-Zulassung nur mit TPE-Dichteinsatz  
VDE approval only with TPE sealing insert

**i** Farbvarianten für  
Colour variants for

PC:	PCn = Schwarz
PVDF:	ya = Blau
	yn = Schwarz
PC:	PCn = black
PVDF:	ya = blue
	yn = black

**i** Varianten aus Polycarbonat (PC) und PVDF: Schutzart IP 68 (und Type 4X für PC) ausschließlich in Verbindung mit separat erhältlicher Flachdichtung auf Seite 407  
Polycarbonate (PC) and PVDF version: type of protection IP 68 (and Type 4X for PC) only in combination with separately available flat gasket on page 407



**UNI Silikon Mehrfach Kabelverschraubung**

UNI Silicone Multiple cable gland



Abb. 1  
Fig. 1

Abb. 2  
Fig. 2

**Messing vernickelt, Edelstahl 1.4305, Polycarbonat, PVDF**  
**Metrisches Anschlussgewinde nach EN 60423**  
**Schutzart IP 65**  
**Schutzart IP 68 bis 10 bar, wenn Kabel- $\phi$  = Loch- $\phi$**   
**Zugentlastung bis Klasse A, EN 62444**

*Brass, nickel-plated, stainless steel AISI 303, polycarbonate, PVDF*  
*Metric connection thread according to EN 60423*  
*Type of protection IP 65*  
*Type of protection IP 68 up to 10 bar, achievable if cable  $\phi$  = hole  $\phi$*   
*Strain relief up to class A, EN 62444*

i	<b>Farbvarianten für</b>	<b>PC:</b>	<b>PCn = Schwarz</b>
	Colour variants for	<b>PVDF:</b>	<b>ya = Blau</b>
			<b>yn = Schwarz</b>
		<i>PC: PCn = black</i>	<i>ya = blue</i>
		<i>PVDF: yn = black</i>	<i>yn = black</i>

Werkstoff Verschraubungskörper <i>Material gland body</i>	Ausführung/Farbe <i>Version/colour</i>	Bestellschlüssel <i>Art. no. supplement</i>	Werkstoff Dichteinsatz <i>Material sealing insert</i>	Farbe <i>Colour</i>	Temperaturbereich min./max. <i>Temperature range (min./max.)</i>
Messing <i>Brass</i>	Vernickelt <i>Nickel-plated</i>	d	Silikon HT <i>Silicone HT</i>	Schwarz <i>Black</i>	-55 °C / +200 °C
VA 1.4305 <i>AISI 303</i>	Blank	st	Silikon HT <i>Silicone HT</i>	Schwarz <i>Black</i>	-55 °C / +200 °C
PC	Grau <i>Grey</i>	PC	Silikon HT <i>Silicone HT</i>	Schwarz <i>Black</i>	-20 °C / +100 °C
PVDF	Transparent	y	Silikon HT <i>Silicone HT</i>	Schwarz <i>Black</i>	-40 °C / +150 °C



Abb. 3 – Beispiel „2 x 3“  
 2 = Anzahl Bohrungen  
 3 = Bohrungsdurchmesser in mm  
 Fig. 3 – Example “2 x 3”  
 2 = Number of holes  
 3 = Hole diameter in mm

Anschlussgewinde <i>Connection thread</i>	Art.-Nr. <i>Art. no.</i>	Ausführung bitte ergänzen <i>Please indicate product details</i>	
<b>A</b>		Messing/Brass	= d
		VA 1.4305/AISI 303	= st
		PC	= PC
		PVDF	= y
M16x1,5	21650	im2x4HT	50
M20x1,5	22052	im2x5HT	50
	22052	im4x3HT	50
	22052	im4x4HT	50
	22052	im5x2HT	50
M25x1,5	22553	im4x5HT	50
	22553	im4x6HT	50
M32x1,5	23254	im3x7HT	25
	23254	im3x9HT	25
	23254	im4x4HT	25
	23254	im4x6HT	25
	23254	im4x8HT	25
M40x1,5	24055	im2x13HT	10
	24055	im3x11HT	10
	24055	im5x9HT	10
	24055	im7x7HT	10

**UNI Dicht mit geschlossenem Dichteinsatz**

UNI Dicht with closed sealing insert

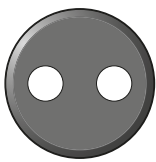
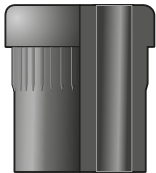

Abb. 1  
Fig. 1



Abb. 2  
Fig. 2

**Messing vernickelt, Edelstahl 1.4305, Polycarbonat, PVDF**  
**Metrisches Anschlussgewinde nach EN 60423**  
**Schutzart IP 68 bis 10 bar**

Brass, nickel-plated, stainless steel AISI 303, polycarbonate, PVDF  
Metric connection thread according to EN 60423  
Type of protection IP 68 up to 10 bar

**i** **Maximaler Kabeldurchlass der Druckschraube (F) und maximaler Kabeldurchlass des Doppelnippels (E) siehe Technischer Anhang**  
For maximum cable passage of pressure screw (F) and maximum cable passage of double nipple (E), see Technical Appendix

Werkstoff Verschraubungskörper Material gland body	Ausführung/Farbe Version/colour	Bestellschlüssel Art. no. supplement	Werkstoff Dichteinsatz Material sealing insert	Farbe Colour	Temperaturbereich min./max. Temperature range (min./max.)
Messing Brass	Vernickelt Nickel-plated	d	TPE-V	Natur Natural	-40 °C / +135 °C
VA 1.4305 AISI 303	Blank	st	TPE-V	Natur Natural	-40 °C / +135 °C
PC	Grau Grey	PC	TPE-V	Natur Natural	-20 °C / +100 °C
PVDF	Transparent	y	TPE-V	Natur Natural	-40 °C / +135 °C



Abb. 3  
Fig. 3

Anschlussgewinde Connection thread	Art.-Nr. Art. no.	Ausführung bitte ergänzen Please indicate product details	
A	Messing/Brass	= d	
	VA 1.4305/AISI 303	= st	
	PC	= PC	
	PVDF	= y	
M16x1,5	21650	pg	50
M20x1,5	22051	pg	50
		pg *	50
M25x1,5	22553	pg	50
		pg	25
M32x1,5	23254	pg	25
		pg/21 **	25
M40x1,5	24055	pg	10
		pg ***	10
M50x1,5	25056	pg	5
		pg *** ****	5
M63x1,5	26358	pg ****	5

\* Bei Variante y und PC Dichteinsatz kurz = Art.-Nr. Ek... \*\* Variante in y und PC nicht erhältlich. \*\*\* Dichteinsatz kurz = Art.-Nr. Ek...  
\*\*\*\* Variante y und PC aus Werkstoff POM (Farbe Weiß); Temperaturbereich: -40 °C bis +110 °C.

\* Variant y and PC sealing insert short = Art. no. Ek... \*\* Variant y and PC not available. \*\*\* Sealing insert short = Art. no. Ek... \*\*\*\* Variant y and PC made of POM (white), temperature range: -40 °C up to +110 °C.

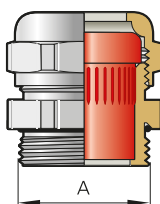
**i** **Die Anleitung zur Herstellung einer Kabelverschraubung mit eigenem Lochbild aus einem geschlossenem Dichteinsatz finden Sie im Technischen Anhang.**  
The instructions for making a cable gland with your own hole pattern from a closed sealing insert can be found in the Technical Appendix.

**i** **Varianten aus Polycarbonat (PC) und PVDF: Schutzart IP 68 ausschließlich in Verbindung mit separat erhältlicher Flachdichtung auf Seite 407**  
Polycarbonate (PC) and PVDF version: type of protection IP 68 only in combination with separately available flat gasket on page 407

**i** **Farbvarianten für** **PC: PCn = Schwarz**  
**PVDF: ya = Blau**  
**yn = Schwarz**  
Colour variants for **PC: PCn = black**  
**PVDF: ya = blue**  
**yn = black**

## UNI Stecker-Kabelverschraubung mit geteiltem Dichteinsatz

UNI connector cable gland with split sealing insert

CE RoHS



Abb. 1  
Fig. 1



Abb. 2  
Fig. 2

**Messing vernickelt, Edelstahl 1.4305, Polycarbonat, PVDF**  
**Metrisches Anschlussgewinde nach EN 60423**  
**Schutzart IP 68 bis 10 bar**

*Brass, nickel-plated, stainless steel AISI 303, polycarbonate, PVDF*  
*Metric connection thread according to EN 60423*  
*Type of protection IP 68 up to 10 bar*

i	<b>Farbvarianten für</b>	<b>PC:</b>	<b>PCn = Schwarz</b>
	<i>Colour variants for</i>	<b>PVDF:</b>	<b>ya = Blau</b>
			<b>yn = Schwarz</b>
		<i>PC:</i>	<i>PCn = black</i>
		<i>PVDF:</i>	<i>ya = blue</i>
			<i>yn = black</i>

Werkstoff Verschraubungskörper <i>Material gland body</i>	Ausführung/Farbe <i>Version/colour</i>	Bestellschlüssel <i>Art. no. supplement</i>	Werkstoff Dichteinsatz <i>Material sealing insert</i>	Farbe <i>Colour</i>	Temperaturbereich min./max. <i>Temperature range (min./max.)</i>
Messing <i>Brass</i>	Vernickelt <i>Nickel-plated</i>	d	TPE-V	Natur <i>Natural</i>	-40 °C / +135 °C
VA 1.4305 <i>AISI 303</i>	Blank	st	TPE-V	Natur <i>Natural</i>	-40 °C / +135 °C
PC	Grau <i>Grey</i>	PC	TPE-V	Natur <i>Natural</i>	-20 °C / +100 °C
PVDF	Transparent	y	TPE-V	Natur <i>Natural</i>	-40 °C / +135 °C

Anschlussgewinde <i>Connection thread</i>	Art.-Nr. <i>Art. no.</i>	Ausführung bitte ergänzen <i>Please indicate product details</i>	
A		Messing/Brass	= d
		VA 1.4305/AISI 303	= st
		PC	= PC
		PVDF	= y
M40x1,5	24055	pmK	10
	24055	pmK 1/ 5	10
	24055	pmK 1/ 6	10
	24055	pmK 1/ 7	10
	24055	pmK 1/ 8	10
	24055	pmK 1/10	10
	24055	pmK 1/12	10
	24055	pmK 1/13,5	10
	24055	pmK 1/17	10
	24055	pmK 1/21	10
	24055	pmK 1/6-1/ 8,5	10
	24055	pmK 2/6	10
	24055	pmK 2/8	10
	24055	pmK 2/10	10
24056	pmK *	10	
M50x1,5	25056	pmK	5
	25056	pmK 1/ 4,5	5
	25056	pmK 1/ 8	5
	25056	pmK 1/10	5
	25056	pmK 1/11	5
	25056	pmK 1/12	5
	25056	pmK 1/21	5
	25056	pmK 1/23	5
	25056	pmK 1/4,5-1/ 9-1/9,5	5
	25056	pmK 1/5-1/10-1/10,5	5
	25056	pmK 1/8-1/10,5-1/12	5
	25056	pmK 2/6	5
	25056	pmK 2/8	5
	25056	pmK 2/11,5	5
25056	pmK 2/5,5-1/11,5	5	

Technische Details und Informationen zu Zulassungen ab Seite 419  
For technical details and information on certifications, see page 419 ff.

\* Dichteinsatz kurz = Art.-Nr. Ek...  
\* Sealing insert short = Art. no. Ek...

Fortsetzung auf der nächsten Seite  
Continued on next page

## UNI Stecker-Kabelverschraubung mit geteiltem Dichteinsatz

UNI connector cable gland with split sealing insert

Fortsetzung von vorheriger Seite  
Continued from previous page

Anschlussgewinde Connection thread	Art.-Nr. Art. no.	Ausführung bitte ergänzen Please indicate product details		
		Messing/Brass	= d	
A		VA 1.4305/AISI 303	= st	
		PC	= PC	
		PVDF	= y	
	M50x1,5	25056	pmK 3/7,2	5
		25056	pmK 3/7,5	5
		25056	pmK 3/7,8	5
		25056	pmK 3/10	5
		25057	pmK * **	5
		25057	pmK 1/9 * **	5
		25057	pmK 1/22	5

Anschlussgewinde Connection thread	Art.-Nr. Art. no.	Ausführung bitte ergänzen Please indicate product details		
		Messing/Brass	= d	
A		VA 1.4305/AISI 303	= st	
		PC	= PC	
		PVDF	= y	
	M50x1,5	25057	pmK 1/32 * **	5
		25057	pmK 2/9 * **	5
	M63x1,5	26358	pmK **	5
		26358	pmK 1/6 **	5
		26358	pmK 1/6-1/8 **	5
		26358	pmK 1/8 **	5
		26358	pmK 1/28 **	5

\* Dichteinsatz kurz = Art.-Nr. Ek... \*\* Variante y und PC aus Werkstoff POM (Farbe Weiß); Temperaturbereich: -40 °C bis +110 °C.  
\* Sealing insert short = Art. no. Ek... \*\* Variant y and PC made of POM (white), temperature range: -40 °C up to +110 °C.

**i** Varianten aus Polycarbonat (PC) und PVDF: Schutzart IP 68 ausschließlich in Verbindung mit separat erhältlicher Flachdichtung auf Seite 407  
Polycarbonate (PC) and PVDF version: type of protection IP 68 only in combination with separately available flat gasket on page 407

210000 | TT01920

## UNI Dicht ASI-Bus-Kabelverschraubung

UNI Dicht ASI-Bus cable gland

CE RoHS



Abb. 1  
Fig. 1



Abb. 2  
Fig. 2

**Messing vernickelt, Edelstahl 1.4305, Polycarbonat, PVDF**  
**Metrisches Anschlussgewinde nach EN 60423**  
**Für ASI-Kabel nach IEC 62026-2**  
**Schutzart IP 68 bis 10 bar**

*Brass, nickel-plated, stainless steel AISI 303, polycarbonate, PVDF*  
*Metric connection thread according to EN 60423*  
*For ASI cable according to IEC 62026-2*  
*Type of protection IP 68 up to 10 bar*

**Farbvarianten für**  
 Colour variants for

<b>PC:</b>	<b>PCn = Schwarz</b>
<b>PVDF:</b>	<b>ya = Blau</b>
	<b>yn = Schwarz</b>
	<i>PCn = black</i>
	<i>ya = blue</i>
	<i>yn = black</i>

Werkstoff Verschraubungskörper Material gland body	Ausführung/Farbe Version/colour	Bestellschlüssel Art. no. supplement	Werkstoff Dichteinsatz Material sealing insert	Farbe Colour	Temperaturbereich min./max. Temperature range (min./max.)
Messing Brass	Vernickelt Nickel-plated	d	TPE-V	Natur Natural	-40 °C / +135 °C
VA 1.4305 AISI 303	Blank	st	TPE-V	Natur Natural	-40 °C / +135 °C
PC	Grau Grey	PC	TPE-V	Natur Natural	-20 °C / +100 °C
PVDF	Transparent	y	TPE-V	Natur Natural	-40 °C / +135 °C



Abb. 3  
Fig. 3



Abb. 4 – ASI-Kabel-Querschnitt 2x links = lange Bezugs-kante  
 Fig. 4 – ASI cable cross section dual left = long reference edge

Anschlussgewinde Connection thread	Art.-Nr. Art. no.	Version ASI Version Asi
	Ausführung bitte ergänzen Please indicate product details	
	Messing/Brass = d	
	VA 1.4305/AISI 303 = st	
<b>A</b>	PC = PC	
	PVDF = y	
M20x1,5	22052	pm2xASI L 2x links/2x left 50
	22052	pm2xASI R 2x rechts/2x right 50
	22052	pf4,2ASI10L links/left 50
	22052	pfm2xASIL/R links & rechts/left & right 50
	22052	pf4,2ASI10R rechts/right 50

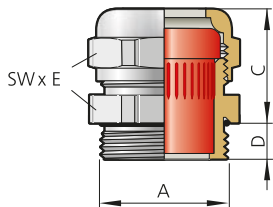
70100 | TT02510

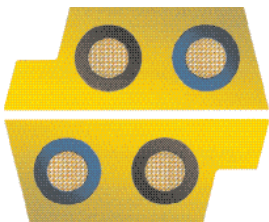

Abb. 1  
Fig. 1



Abb. 2  
Fig. 2

**Messing vernickelt, Edelstahl 1.4305, Polycarbonat, PVDF**  
**Schutzart IP 65**  
**Form: gerundet**

Brass, nickel-plated, stainless steel AISI 303, polycarbonate, PVDF  
Type of protection IP 65  
Rounded shape

**i** **Farbvarianten für** **PC:** **PCn = Schwarz**  
**Color variants for** **PVDF:** **ya = Blau**  
**PC:** **yn = Schwarz**  
**PVDF:** **PCn = black**  
**ya = blue**  
**yn = black**

Werkstoff Verschraubungskörper	Ausführung/Farbe	Bestellschlüssel	Werkstoff Dichteinsatz	Farbe	Bestellschlüssel	Temperaturbereich min./max.
Material gland body	Version/colour	Art. no. supplement	Material sealing insert	Colour	Art. no. supplement	Temperature range (min./max.)
Messing Brass	Vernickelt Nickel-plated	d	TPE	Weiß White		-40 °C / +130 °C
Messing Brass	Vernickelt Nickel-plated	d	TPE-V	Natur Natural	p	-40 °C / +135 °C
VA 1.4305 AISI 303	Blank	st	TPE	Weiß White		-40 °C / +130 °C
VA 1.4305 AISI 303	Blank	st	TPE-V	Natur Natural	p	-40 °C / +135 °C
PC	Grau Grey	PC	TPE	Weiß White		-20 °C / +100 °C
PC	Grau Grey	PC	TPE-V	Natur Natural	p	-20 °C / +100 °C
PVDF	Transparent	y	TPE	Weiß White		-40 °C / +130 °C
PVDF	Transparent	y	TPE-V	Natur Natural	p	-40 °C / +135 °C



Abb. 3  
Fig. 3

Anschlussgewinde	Art.-Nr.		
Connection thread	Art. no.	Ausführung bitte ergänzen Please indicate product details	
		Messing/Brass = d	
		VA 1.4305/AISI 303 = st	
<b>A</b>		PC = PC	= TPE
		PVDF = y	p = TPE-V
M16x1,5	21650	f 3,5g 5,5	50
M20x1,5	22051	f 2,8g10,5	50
	22051	f 3,5g 9	50
	22051	f 4 g 6	50
	22052	f 3 g12 *	50
	22052	f 4,5g10 *	50
	22052	f 5 g11 *	50
	22052	f 5 g12 *	50
M25x1,5	22553	f 6,5g11 *	50
	22553	f 5 g16	50
	22553	f 5 g10	50
	22553	f 5 g12	50
	22553	f 5,5g14	50
	22553	f 6 g13	50
M32x1,5	23254	f 7,5g14	50
	23254	f 5 g17	25
M40x1,5	24055	f 7 g18	25
	24055	f 6 g29	10
	24055	f 8 g25	10
	24055	f10 g25	10
	24055	f10 g29	10
M50x1,5	25056	f13 g28	10
	25056	f 6 g30	5

\* Bei Variante y und PC Dichteinsatz kurz = Art.-Nr. Ek...

\* Variant y and PC sealing insert short = Art. no. Ek...

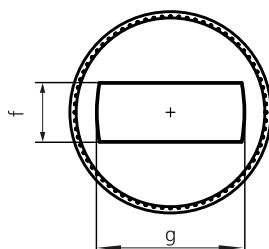
Technische Details und Informationen zu Zulassungen ab Seite 419  
For technical details and information on certifications, see page 419

Fortsetzung auf der nächsten Seite  
Continued on next page

## UNI Flach Kabelverschraubung – Gerundet

UNI Flat cable gland – Rounded

Fortsetzung von vorheriger Seite  
Continued from previous page

Anschlussgewinde Connection thread	Art.-Nr. Art. no.	Ausführung bitte ergänzen Please indicate product details		
		Messing/Brass	= d	
A M50x1,5		VA 1.4305/AISI 303	= st	
		PC	= PC	= TPE
		PVDF	= y	p = TPE-V
		25056	f 6 g36	5
		25057	f 6 g38 * **	5
		25056	f 8 g36	5
		25056	f11 g34	5
		25056	f12 g35	5
	25057	f10 g38 * **	5	
	25057	f14,5g37 * **	5	

Anschlussgewinde Connection thread	Art.-Nr. Art. no.	Ausführung bitte ergänzen Please indicate product details		
		Messing/Brass	= d	
A M63x1,5		VA 1.4305/AISI 303	= st	
		PC	= PC	= TPE
		PVDF	= y	p = TPE-V
		26358	f 6,5g47 **	5
		26358	f 9 g43 **	5
		26358	f14,5g39 **	5
		26358	f15 g45	5
	M75x1,5	275212	f15 g45 ***	1
275212		f18 g54 ***	1	

23300 | IT01900

\* Dichteinsatz kurz = Art.-Nr. Ek... \*\* Variante PC nicht lieferbar. Variante y aus Werkstoff POM (Farbe Weiß), Temperaturbereich: -40 °C bis +110 °C. \*\*\* Variante in y und PC nicht erhältlich.  
\* Sealing insert short = Art. no. Ek... \*\* Variant PC not available. Variant y made of POM (white), temperature range: -40 °C up to +110 °C. \*\*\* Variant y and PC not available.

**i** Verschraubung auch mit Pg-Anschlussgewinde erhältlich  
Gland also available with Pg connection thread

**UNI Flach Kabelverschraubung – Oval**

UNI Flat cable gland – Oval



Abb. 1  
Fig. 1



Abb. 2  
Fig. 2

**Messing vernickelt, Edelstahl 1.4305, Polycarbonat, PVDF**  
**Schutzart IP 65**  
**Form: oval**

Brass, nickel-plated, stainless steel AISI 303, polycarbonate, PVDF  
Type of protection IP 65  
Oval shape

<b>i</b>	<b>Farbvarianten für</b>	<b>PC:</b>	<b>PCn = Schwarz</b>
	Colour variants for	<b>PVDF:</b>	<b>ya = Blau</b>
			<b>yn = Schwarz</b>
			<b>PCn = black</b>
	<b>PC:</b>	<b>ya = blue</b>	
	<b>PVDF:</b>	<b>yn = black</b>	
		<b>PCn = black</b>	
		<b>ya = blue</b>	
		<b>yn = black</b>	

Werkstoff Verschraubungskörper	Ausführung/Farbe	Bestellschlüssel	Werkstoff Dichteinsatz	Farbe	Bestellschlüssel	Temperaturbereich min./max.
Material gland body	Version/colour	Art. no. supplement	Material sealing insert	Colour	Art. no. supplement	Temperature range (min./max.)
Messing Brass	Vernickelt Nickel-plated	d	TPE	Weiß White		-40 °C / +130 °C
Messing Brass	Vernickelt Nickel-plated	d	TPE-V	Natur Natural	p	-40 °C / +135 °C
VA 1.4305 AISI 303	Blank	st	TPE	Weiß White		-40 °C / +130 °C
VA 1.4305 AISI 303	Blank	st	TPE-V	Natur Natural	p	-40 °C / +135 °C
PC	Grau Grey	PC	TPE	Weiß White		-20 °C / +100 °C
PC	Grau Grey	PC	TPE-V	Natur Natural	p	-20 °C / +100 °C
PVDF	Transparent	y	TPE	Weiß White		-40 °C / +130 °C
PVDF	Transparent	y	TPE-V	Natur Natural	p	-40 °C / +135 °C



Abb. 3  
Fig. 3

Anschlussgewinde	Art.-Nr.		
Connection thread	Art. no.	Ausführung bitte ergänzen Please indicate product details	
<b>A</b>	Messing/Brass	= d	
	VA 1.4305/AISI 303	= st	
	PC	= PC	= TPE
	PVDF	= y	p = TPE-V
M10x1,0	21049	f 1,2v 4/1mm *	50
	21049	f 2 v 4/1mm *	50
M10x1,5	21049	f 1,2v 4/1,5mm *	50
	21049	f 2 v 4/1,5mm *	50
M12x1,5	21249	f 1,2v 4 **	50
	21249	f 2 v 4 **	50
M20x1,5	22051	f 4,5v 7	50
	22052	f 2,5v10 ***	50
	22052	f 5 v 8 ***	50
	22052	f 5 v12 ***	50
	22052	f 6 v 10 ***	50
	22052	f 6 v 9,1 ***	50
	22052	f 8 v10,5 ***	50
M25x1,5	22553	f 5 v10	50
	22553	f 5 v12	50
	22553	f 5 v15	50
	22553	f 5,5v 8,5	50
	22553	f 6 v12,5	50
	22553	f 6 v14	50
	22553	f 6 v15	50
	22553	f 7 v14	50
	22553	f 8 v10,5	50

\* Variante in y und PC nicht erhältlich. \*\* Dichteinsatz kurz = Art.-Nr. Ek... \*\*\* Bei Variante y und PC Dichteinsatz kurz = Art.-Nr. Ek...  
\* Variant y and PC not available. \*\* Sealing insert short = Art. no. Ek... \*\*\* Variant y and PC sealing insert short = Art. no. Ek...

Technische Details und Informationen zu Zulassungen ab Seite 419  
For technical details and information on certifications, see page 419 f  
Fortsetzung auf der nächsten Seite  
Continued on next page

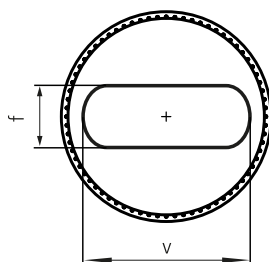

## UNI Flach Kabelverschraubung – Oval

UNI Flat cable gland – Oval

Fortsetzung von vorheriger Seite  
Continued from previous page

Anschlussgewinde Connection thread	Art.-Nr. Art. no.	Ausführung bitte ergänzen Please indicate product details	
		Messing/Brass = d VA 1.4305/AISI 303 = st	PC = TPE PVDF = y p = TPE-V
M25x1,5	22553	f 8 v14	50
	22553	f 9 v15	50
M32x1,5	23254	f 5 v16	25
	23254	f 7 v16,5	25
	23254	f 7 v18	25
	23254	f 7 v20	25
M40x1,5	24055	f10 v27	10
	24055	f 4 v23	10
	24055	f 8 v25	10

Anschlussgewinde Connection thread	Art.-Nr. Art. no.	Ausführung bitte ergänzen Please indicate product details	
		Messing/Brass = d VA 1.4305/AISI 303 = st	PC = TPE PVDF = y p = TPE-V
M40x1,5	24056	f11 v35	10
M50x1,5	25056	f11 v35	5
	25056	f13 v30,5	5
	25056	f 5,5v31	5
	25056	f 6,5v32	5
	25057	f 6 v41 * **	5
	25057	f 9 v38 * **	5
M63x1,5	26358	f 9 v43 **	5
M75x1,5	275212	f 9 v55 ** ***	1

23400 | TT01900

\* Dichteinsatz kurz = Art.-Nr. Ek... \*\* Variante PC nicht lieferbar. Variante y aus Werkstoff POM (Farbe Weiß), Temperaturbereich: -40 °C bis +110 °C. \*\*\* Nur in Messing lieferbar.  
\* Sealing insert short = Art. no. Ek... \*\* Variant PC not available. Variant y made of POM (white), temperature range: -40 °C up to +110 °C. \*\*\* Only available in brass.

**i** Verschraubung auch mit Pg-Anschlussgewinde erhältlich  
Gland also available with Pg connection thread

**UNI Flach Kabelverschraubung – Rechteckig**

UNI Flat cable gland – Rectangular



Abb. 1  
Fig. 1



Abb. 2  
Fig. 2

**Messing vernickelt, Edelstahl 1.4305, Polycarbonat, PVDF**  
**Schutzart IP 43**  
**Form: rechteckig**

Brass, nickel-plated, stainless steel AISI 303, polycarbonate, PVDF  
Type of protection IP 43  
Rectangular shape

i	<b>Farbvarianten für</b>	<b>PC:</b>	<b>PCn = Schwarz</b>
	Colour variants for	<b>PVDF:</b>	<b>ya = Blau</b>
		<b>PC:</b>	<b>yn = Schwarz</b>
		<b>PVDF:</b>	<b>PCn = black</b>
			<b>ya = blue</b>
			<b>yn = black</b>

Werkstoff Verschraubungskörper	Ausführung/Farbe	Bestellschlüssel	Werkstoff Dichteinsatz	Farbe	Bestellschlüssel	Temperaturbereich min./max.
Material gland body	Version/colour	Art. no. supplement	Material sealing insert	Colour	Art. no. supplement	Temperature range (min./max.)
Messing Brass	Vernickelt Nickel-plated	d	TPE	Weiß White		-40 °C / +130 °C
Messing Brass	Vernickelt Nickel-plated	d	TPE-V	Natur Natural	p	-40 °C / +135 °C
VA 1.4305 AISI 303	Blank	st	TPE	Weiß White		-40 °C / +130 °C
VA 1.4305 AISI 303	Blank	st	TPE-V	Natur Natural	p	-40 °C / +135 °C
PC	Grau Grey	PC	TPE	Weiß White		-20 °C / +100 °C
PC	Grau Grey	PC	TPE-V	Natur Natural	p	-20 °C / +100 °C
PVDF	Transparent	y	TPE	Weiß White		-40 °C / +130 °C
PVDF	Transparent	y	TPE-V	Natur Natural	p	-40 °C / +135 °C



Abb. 3  
Fig. 3

Anschlussgewinde	Art.-Nr.
Connection thread	Art. no.
	Ausführung bitte ergänzen Please indicate product details
	Messing/Brass = d
	VA 1.4305/AISI 303 = st
<b>A</b>	PC = PC = TPE
	PVDF = y p = TPE-V
M25x1,5	22553 f 8 e12 50
M32x1,5	23254 f 4 e15 25
M40x1,5	24055 f 6 e26 10
M50x1,5	25057 f 6 e39 * ** 5

\* Dichteinsatz kurz = Art.-Nr. Ek... \*\* Variante PC nicht lieferbar. Variante y aus Werkstoff POM (Farbe Weiß), Temperaturbereich: -40 °C bis +110 °C.  
\* Sealing insert short = Art. no. Ek... \*\* Variant PC not available. Variant y made of POM (white), temperature range: -40 °C up to +110 °C.

**i Verschraubung auch mit Pg-Anschlussgewinde erhältlich**  
Gland also available with Pg connection thread

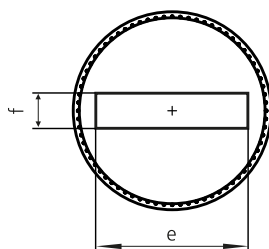

## Zugentlastung und Biegeschutz – metrisch

*Strain relief  
and bending protection – metric*



Abb. 1 – UNI Biegeschutz Dicht Kabelverschraubung  
Fig. 1 – UNI Dicht Bending protection cable gland

Abb. 2 – UNI Zug Dicht Kabelverschraubung  
Fig. 2 – UNI Dicht Strain relief cable gland

Abb. 3 – UNI Flex Dicht  
Fig. 3 – UNI Flex Dicht

### Erhöhte Zugentlastung inklusive

PFLITSCH Kabelverschraubungen verfügen bereits serienmäßig über Zugentlastungswerte, die der Norm EN 62444, Klasse A, entsprechen. Noch mehr Sicherheit durch erhöhte Zugentlastung bringen die Baureihen UNI Zug, UNI Klemm und UNI Biege Zug aus dem UNI Dicht Baukasten. Ebenso sind hier Lösungen für einen umfassenden Biegeschutz zu finden.

### UNI Zug mit integrierten Spannbacken

Bei der UNI Zug bestehen die Dichteinsätze aus TPE und TPE-V mit integrierten Klemmkörpern aus PA, die wie ein Spannfutter wirken und Zugkräfte bis über 200 N am Kabel vibrationsfest abfangen.

### UNI Klemm mit Bügelschellen

Mit zwei Bügelschellen an der Druckschraube lassen sich bei der UNI Klemm Kabel sicher fixieren. Dabei werden Zugkräfte bis über 500 N abgefangen. UNI Klemm entspricht damit der in der Norm EN 62444 geforderten „Ausführung B“.

### UNI Biegeschutz Dicht Kabelverschraubungen

Diese Kabelverschraubungen verhindern durch eine lange, konische Biegeschutztülle aus TPE-V, dass die Kabel an der Biegestelle beschädigt werden. Die Tülle liegt fest am Kabel an und hält äußere Einflüsse, wie z.B. UV-Strahlung und aggressive Medien, von dem unter Biegestress stehenden Kabelabschnitt fern. Zur einfacheren Montage kann die Tülle aufgeweitet werden, um das Kabel leichter durchschieben zu können.

### UNI Biege Zug – die perfekte Kombination

Eine interessante Variante ist die UNI Biege Zug Kabelverschraubung. Ihr Dichteinsatz ist mit Spannbacken für eine vibrationsfeste Zugentlastung ausgestattet und verfügt über eine angespritzte große Tülle, die das Kabel sicher vor dem Abknicken schützt, beispielsweise bei Industrie-Steckverbindern.

### UNI Flex für noch mehr Biegeschutz

Mit einer speziell gewendelten Edelstahlfeder optimiert die UNI Flex die Verteilung der Biegebeanspruchungen des Kabels. Auf etwa 10 cm Länge fängt diese Kabelverschraubung selbst hohe dynamische Biegebelastungen am Kabeleintritt sicher ab.

### Increased strain relief included

The standard PFLITSCH cable glands are already capable of strain relief ratings that meet EN 62444 class A standards. The UNI Strain relief, UNI Clamping and UNI Bending Strain relief series from the UNI Dicht modular system provide even more safety with increased strain relief. Solutions for comprehensive bending protection are also available.

### UNI Strain relief with integrated jaws

The sealing inserts of the UNI Strain Relief are made of TPE and TPE-V with integrated clamps made of PA, which act like a jaw chuck and absorb tensile forces of up to over 200 N on the cable, making it vibration-proof.

### UNI Clamping with bracket clamps

The two bracket clamps on the pressure screw of the UNI Clamping enable cables to be reliably fixed. They are capable of absorbing tensile forces of over 500 N. The UNI Clamping therefore meets the “B-version” required by the EN 62444 standard.

### UNI Bending protection cable glands

With these cable glands, a long, conical bending protection grommet made of TPE-V prevents the cables from being damaged at the bending point. The grommet fits tightly around the cable and also protects the section under bending stress from outside influences such as UV radiation and aggressive media. For easier installation, the grommet can be widened to make it easier to push the cable through.

### UNI Bending Strain relief – the perfect combination

The UNI Bending Strain relief cable gland is an interesting variant. Its sealing insert is fitted with clamping jaws for vibration-proof strain relief and also has a large moulded grommet that reliably protects the cable from kinking, for example in industrial connectors.

### UNI Flex for even better bending protection

The UNI Flex uses a specially coiled stainless steel spring with a progressive characteristic curve to optimise the distribution of bending stresses on the cable. Over a length of about 10 cm, this cable gland reliably absorbs even heavy dynamic bending stresses at the cable entry.

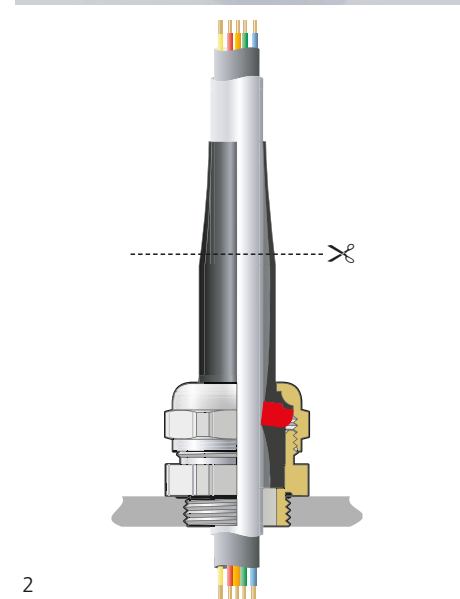

- ✂ Durch Kürzen des Konus wird die Tülle an den jeweiligen Kabelquerschnitt angepasst.
- ✂ Shortening the cone enables the socket to be adapted to the cable cross section concerned.



Abb. 1 – UNI Klemm Dicht Kabelverschraubung  
Fig. 1 – UNI Clamping Dicht cable gland

Abb. 2 – Querschnitt UNI Biege Zug  
Fig. 2 – Cross section of the UNI Bending Strain relief

**UNI Zug Dicht Kabelverschraubung**

UNI Dicht Strain relief cable gland



Abb. 1  
Fig. 1



Abb. 2  
Fig. 2

**Messing vernickelt**  
**Metrisches Anschlussgewinde nach EN 60423**  
**Mit O-Ring aus HNBR**  
**Schutzart IP 54**

Brass, nickel-plated  
Metric connection thread according to EN 60423  
With o-ring made of HNBR  
Type of protection IP 54

**i Auf Anfrage erhältlich: Anschlussgewindelänge 15 mm und Ausführung in Edelstahl**  
Available on request: connection thread length 15 mm and in stainless steel

Werkstoff Verschraubungskörper Material gland body	Ausführung/Farbe Version/colour	Werkstoff Dichteinsatz Material sealing insert	Farbe Colour	Bestellschlüssel Art. no. supplement	Temperaturbereich min./max. Temperature range (min./max.)
Messing Brass	Vernickelt Nickel-plated	TPE	s. FC See CC		-20 °C / +100 °C
Messing Brass	Vernickelt Nickel-plated	TPE-V	Natur Natural	p	-20 °C / +100 °C



Abb. 3  
Fig. 3

Anschlussgewinde/-länge Connection thread/length		Art.-Nr. Art. no.	Dichtbereich Sealing range	Bauhöhe Mounting height	Schlüsselweite Spanner width		
A	D mm	TPE = TPE-V = p	max./min. ø mm	C mm	SW <sub>1</sub> x E <sub>1</sub> /SW <sub>2</sub> x E <sub>2</sub> mm		
M10x1,0	5,0	21049d	z 7/1mm	6,5– 4,0	19,0	14x15,5	50
M10x1,5	5,0	21049d	z 7/1,5mm	6,5– 4,0	19,0	14x15,5	50
M12x1,5	5,0	21249d	z 7	6,5– 4,0	20,0	14x15,5	50
		21250d	z 9 *	9,0– 5,5	21,0	17x18,9	50
M16x1,5	6,0	21650d	z 7	6,5– 4,0	20,0	18x20/17x18,9	50
		21650d	z 9	9,0– 5,5	20,0	18x20/17x18,9	50
		21651d	z 11 *	10,0– 6,0	21,0	20x22,2	50
		21652d	z 13 *	12,0– 8,0	21,0	22x24,4	50
M20x1,5	6,5	22052d	z 9	9,0– 5,5	21,0	22x24,4	50
		22052d	z 11	10,0– 6,0	21,0	22x24,4	50
		22052d	z 13	12,0– 8,0	21,0	22x24,4	50
		22053d	z 16 *	15,0– 12,0	21,0	24x26,7	50
		22054d	z 18 *	17,0– 14,0	24,0	30x33,5	25
		22054d	z 20 *	20,0– 16,0	24,0	30x33,5	25
M25x1,5	7,5	22553d	z 11	10,0– 6,0	21,0	28x31,2/24x26,7	50
		22553d	z 13	12,0– 8,0	21,0	28x31,2/24x26,7	50
		22553d	z 16	15,0– 12,0	21,0	28x31,2/24x26,7	50
		22554d	z 18 *	17,0– 14,0	25,0	30x33,5	25
		22554d	z 20 *	20,0– 16,0	25,0	30x33,5	25
		22555d	z 25 *	24,0– 20,0	25,0	40x43,5	10
		22555d	z 28 *	27,0– 23,0	25,0	40x43,5	10
M32x1,5	8,0	23254d	z 13	12,0– 8,0	26,0	35x38,5/30x33,5	25
		23254d	z 16	15,0– 12,0	26,0	35x38,5/30x33,5	25
		23254d	z 18	17,0– 14,0	26,0	35x38,5/30x33,5	25
		23254d	z 20	20,0– 16,0	26,0	35x38,5/30x33,5	25
		23255d	z 25 *	24,0– 20,0	29,0	40x43,5	25
		23255d	z 28 *	27,0– 23,0	29,0	40x43,5	10
		M40x1,5	8,0	24055d	z 20	20,0– 16,0	29,0
24055d	z 25			24,0– 20,0	29,0	43x47,3/40x43,5	10
24055d	z 28			27,0– 23,0	29,0	43x47,3/40x43,5	10
M40x1,5	9,0	24056d	z 32 *	31,5– 27,0	28,0	50x54	10
		24056d	z 36 *	36,0– 32,0	28,0	50x54	10
M50x1,5	10,0	25056d	z 32	31,5– 27,0	30,0	54x58/50x54	5
		25056d	z 36	36,0– 32,0	30,0	54x58/50x54	5
		25057d	z 40 *	40,0– 34,0	30,0	57x61	5
M63x1,5	10,0	26358d	z 44	43,0– 39,0	30,0	68x74/64x69	5

\* Dichteinsatz kurz = Art.-Nr. Ek...  
\* Sealing insert short = Art. no. Ek...

**i Verschraubung auch mit Pg-Anschlussgewinde erhältlich**  
Gland also available with Pg connection thread

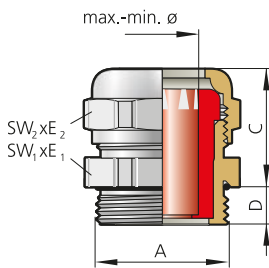
Technische Details und Informationen zu Zulassungen ab Seite 419  
For technical details and information on certifications, see page 419 ff.

**UNI Zug Dicht Kabelverschraubung**

UNI Dicht Strain relief cable gland



Abb. 1  
Fig. 1

Abb. 2  
Fig. 2

**Polycarbonat, Farben: Grau (RAL 7035), Schwarz (RAL 9005)**  
**Metrisches Anschlussgewinde nach EN 60423**  
**Schutzart IP 54**

Polycarbonate, colours: grey (RAL 7035), black (RAL 9005)  
Metric connection thread according to EN 60423  
Type of protection IP 54

**i** Verschraubung auch mit Pg-Anschlussgewinde erhältlich  
Gland also available with Pg connection thread

Werkstoff Verschraubungskörper Material gland body	Ausführung/Farbe Version/colour	Bestellschlüssel Art. no. supplement	Werkstoff Dichteinsatz Material sealing insert	Farbe Colour	Bestellschlüssel Art. no. supplement	Temperaturbereich min./max. Temperature range (min./max.)
PC	Grau Grey		TPE	s. FC See CC		-20 °C / +100 °C
PC	Grau Grey		TPE-V	Natur Natural	p	-20 °C / +100 °C
PC	Schwarz Black	n	TPE	s. FC See CC		-20 °C / +100 °C
PC	Schwarz Black	n	TPE-V	Natur Natural	p	-20 °C / +100 °C



Abb. 3  
Fig. 3

Anschlussgewinde/-länge Connection thread/length		Art.-Nr. Art. no.	Dichtbereich Sealing range	Bauhöhe Mounting height	Schlüsselweite Spanner width
Ausführung bitte ergänzen Please indicate product details					
<b>A</b>	<b>D</b> mm	Grau/Grey = Schwarz/Black = n p	= TPE = TPE-V	<b>max./min. ø</b> mm	<b>C</b> mm
M12x1,5	8,0	21249PC 21250PC	z 7 z 9 *	6,5 – 4,0 9,0 – 5,5	22,0 22,0
M16x1,5	9,0	21650PC 21650PC 21651PC	z 7 z 9 z11 *	6,5 – 4,0 9,0 – 5,5 10,0 – 6,0	22,0 22,0 23,0
M20x1,5	9,0	22052PC 22052PC 22052PC 22053PC	z 9 * z11 * z13 * z16 *	9,0 – 5,5 10,0 – 6,0 12,0 – 8,0 15,0 – 12,0	23,0 23,0 23,0 24,0
M25x1,5	9,0	22553PC 22553PC 22553PC	z11 z13 z16	10,0 – 6,0 12,0 – 8,0 15,0 – 12,0	24,0 24,0 24,0
M25x1,5	11,0	22554PC 22554PC 22555PC 22555PC	z18 * z20 * z25 * z28 *	17,0 – 14,0 20,0 – 16,0 24,0 – 20,0 27,0 – 23,0	29,0 29,0 29,0 29,0
M32x1,5	11,0	23254PC 23254PC 23254PC 23254PC 23255PC 23255PC	z13 z16 z18 z20 z25 * z28 *	12,0 – 8,0 15,0 – 12,0 17,0 – 14,0 20,0 – 16,0 24,0 – 20,0 27,0 – 23,0	29,0 29,0 29,0 29,0 32,0 32,0
M40x1,5	11,5	24055PC 24055PC 24055PC	z20 z25 z28	20,0 – 16,0 24,0 – 20,0 27,0 – 23,0	33,0 33,0 33,0
M40x1,5	13,0	24056PC 24056PC	z32 z36	31,5 – 27,0 36,0 – 32,0	35,0 35,0
M50x1,5	14,0	25056PC 25056PC	z32 z36	31,5 – 27,0 36,0 – 32,0	34,0 34,0
					SW <sub>1</sub> x E <sub>1</sub> / SW <sub>2</sub> x E <sub>2</sub> mm
					50 50 50 50 50 50 50 25 25 25 25 25 25 10 10 10 5 5 5 5

\* Dichteinsatz kurz = Art.-Nr. Ek...  
\* Sealing insert short = Art. no. Ek...

**UNI Zug Dicht Kabelverschraubung**

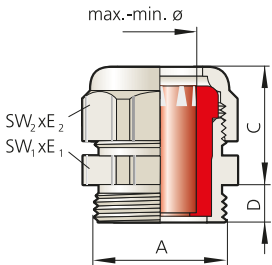
UNI Dicht Strain relief cable gland



Abb. 1  
Fig. 1

Abb. 2  
Fig. 2

**PVDF, Farben: Transparent, Blau (RAL 5015), Schwarz (RAL 9005)**  
**Metrisches Anschlussgewinde nach EN 60423**  
**Schutzart IP 54**

*PVDF, colours: transparent, blue (RAL 5015), black (RAL 9005)*  
*Metric connection thread according to EN 60423*  
*Type of protection IP 54*

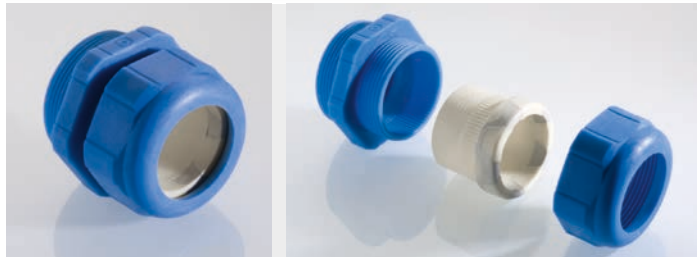
**i Verschraubung mit Pg-Gewinde oder langem Anschlussgewinde auf Anfrage**  
*Gland with Pg thread or long connection thread on request*

Werkstoff Verschraubungskörper <i>Material gland body</i>	Ausführung/Farbe <i>Version/colour</i>	Bestellschlüssel <i>Art. no. supplement</i>	Werkstoff Dichtensatz <i>Material sealing insert</i>	Farbe <i>Colour</i>	Bestellschlüssel <i>Art. no. supplement</i>	Temperaturbereich min./max. <i>Temperature range (min./max.)</i>
PVDF	Transparent		TPE	s. FC See CC		-20 °C / +100 °C
PVDF	Transparent		TPE-V	Natur <i>Natural</i>	p	-20 °C / +100 °C
PVDF	Blau <i>Blue</i>	a	TPE	s. FC See CC		-20 °C / +100 °C
PVDF	Blau <i>Blue</i>	a	TPE-V	Natur <i>Natural</i>	p	-20 °C / +100 °C
PVDF	Schwarz <i>Black</i>	n	TPE	s. FC See CC		-20 °C / +100 °C
PVDF	Schwarz <i>Black</i>	n	TPE-V	Natur <i>Natural</i>	p	-20 °C / +100 °C



Abb. 3  
Fig. 3

Anschlussgewinde/-länge <i>Connection thread/length</i>		Art.-Nr. <i>Art. no.</i>	Dichtbereich <i>Sealing range</i>	Bauhöhe <i>Mounting height</i>	Schlüsselweite <i>Spanner width</i>
Ausführung bitte ergänzen <i>Please indicate product details</i>					
		Transparent = a	= TPE		
		Blau/Blue = n	= TPE-V		
		Schwarz/Black = p			
A	D mm		max./min. ø mm	C mm	SW <sub>1</sub> x E <sub>1</sub> /SW <sub>2</sub> x E <sub>2</sub> mm
M12x1,5	8,0	21249y	z 7 *	6,5– 4,0	15x16,5 50
M16x1,5	8,5	21651y	z11 *	10,0– 6,0	22x24,5 50
M16x1,5	9,0	21650y	z 7	6,5– 4,0	19x21,2 50
		21650y	z 9	9,0– 5,5	19x21,2 50
M20x1,5	9,0	22052y	z 9 *	9,0– 5,5	24x26,5 50
		22052y	z11 *	10,0– 6,0	24x26,5 50
		22052y	z13 *	12,0– 8,0	24x26,5 50
		22053y	z16 *	15,0– 12,0	27x29,5 25
M20x1,5	11,0	22054y	z18 *	17,0– 14,0	33x36,5 50
		22054y	z20 *	20,0– 16,0	33x36,5 50
M25x1,5	9,0	22553y	z11	10,0– 6,0	29x31,5/27x29,5 50
		22553y	z13	12,0– 8,0	29x31,5/27x29,5 50
		22553y	z16	15,0– 12,0	29x31,5/27x29,5 50
M25x1,5	11,0	22554y	z18 *	17,0– 14,0	33x36,5 25
		22554y	z20 *	20,0– 16,0	33x36,5 25
		22555y	z25 *	24,0– 20,0	43x46 25
		22555y	z28 *	27,0– 23,0	43x46 25
M32x1,5	11,0	23254y	z13	12,0– 8,0	38x42/33x36,5 25
		23254y	z16	15,0– 12,0	38x42/33x36,5 25
		23254y	z18	17,0– 14,0	38x42/33x36,5 25
		23254y	z20	20,0– 16,0	38x42/33x36,5 25
		23255y	z25 *	24,0– 20,0	43x46 10
		23255y	z28 *	27,0– 23,0	43x46 10
M40x1,5	11,5	24055y	z20	20,0– 16,0	46x50/43x46,5 10
		24055y	z25	24,0– 20,0	46x50/43x46,5 10
		24055y	z28	27,0– 23,0	46x50/43x46,5 10
M40x1,5	13,0	24056y	z32 *	31,5– 27,0	53x57 5
		24056y	z36 *	36,0– 32,0	53x57 5
M50x1,5	13,0	25056y	z32	31,5– 27,0	56x61/53x57 5
		25056y	z36	36,0– 32,0	56x61/53x57 5
M50x1,5	14,0	25057y	z40 * **	40,0– 36,0	60x65 5
M63x1,5	14,0	26358y	z44 * **	44,0– 39,0	68x73/65x70 5

\* Dichtensatz kurz = Art.-Nr. Ek... \*\* Variante y aus Werkstoff POM (Farbe Weiß); Temperaturbereich: -40 °C bis +110 °C.  
\* Sealing insert short = Art. no. Ek... \*\* Variant y made of POM (white), temperature range: -40 °C up to +110 °C.



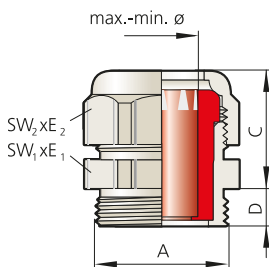

**UNI Klemm Dicht Kabelverschraubung**

UNI Clamping Dicht cable gland



Abb. 1  
Fig. 1



Abb. 2  
Fig. 2

**Messing vernickelt**  
**Metrisches Gewinde nach EN 60423**  
**Mit O-Ring aus HNBR**  
**Schutzart IP 68**

Brass, nickel-plated  
Metric connection thread according to EN 60423  
With o-ring made of HNBR  
Type of protection IP 68

**i** Anschlussgewinde mit 15 mm Länge auf Anfrage  
Long connection thread 15 mm on request

Werkstoff Verschraubungskörper Material gland body	Ausführung/Farbe Version/colour	Werkstoff Dichteinsatz Material sealing insert	Farbe Colour	Bestellschlüssel Art. no. supplement	Temperaturbereich min./max. Temperature range (min./max.)
Messing Brass	Vernickelt Nickel-plated	TPE	s. FC See CC		-40 °C / +130 °C
Messing Brass	Vernickelt Nickel-plated	TPE-V	Natur Natural	p	-40 °C / +135 °C
Messing Brass	Vernickelt Nickel-plated	Silikon HT Silicone HT	Schwarz Black	H	-55 °C / +200 °C



Abb. 3  
Fig. 3

Anschlussgewinde/-länge Connection thread/length		Art.-Nr. Art. no.	Dichtbereich Sealing range	Bauhöhe Mounting height	Schlüsselweite Spanner width	
		Ausführung bitte ergänzen Please indicate product details				
		TPE =				
		TPE-V = p				
		Silikon HT/Silicone HT = H				
A	D mm	Art.-Nr.	max./min. ø mm	C mm	SW <sub>1</sub> x E <sub>1</sub> / SW <sub>2</sub> x E <sub>2</sub> mm	
M12x1,5	5,0	21250d	8zu *	8,0 – 6,0	39,0	17x18,9
		21250d	9zu *	9,5 – 6,5	39,0	17x18,9
M16x1,5	6,0	21650d	8zu	8,0 – 6,0	39,0	18x20/17x18,9
		21650d	9zu	9,5 – 6,5	39,0	18x20/17x18,9
		21651d	11zu *	10,5 – 7,0	39,0	20x22,2
		21652d	13zu *	13,0 – 9,0	39,0	22x24,4
M20x1,5	6,5	22052d	9zu	9,5 – 7,0	39,0	22x24,4
		22052d	11zu	10,5 – 7,0	39,0	22x24,4
		22052d	13zu	13,0 – 9,0	39,0	22x24,4
		22053d	16zu *	15,5 – 11,5	41,0	24x26,7
		22053d	11zu	10,5 – 7,0	41,0	28x31,2/24x26,7
M25x1,5	7,5	22553d	9zu	9,5 – 7,0	41,0	28x31,2/24x26,7
		22553d	11zu	10,5 – 7,0	41,0	28x31,2/24x26,7
		22553d	13zu	13,0 – 9,0	41,0	28x31,2/24x26,7
		22553d	16zu	15,5 – 11,5	41,0	28x31,2/24x26,7
M25x1,5	7,5	22554d	18zu *	18,0 – 14,0	48,0	30x33,5
		22554d	20zu *	20,5 – 17,0	48,0	30x33,5
M32x1,5	8,0	23254d	13zu	13,0 – 10,0	48,0	35x38,5/30x33,5
		23254d	16zu	15,5 – 11,5	48,0	35x38,5/30x33,5
		23254d	18zu	18,0 – 14,0	48,0	35x38,5/30x33,5
		23254d	20zu	20,5 – 17,0	48,0	35x38,5/30x33,5
		23255d	25zu *	25,0 – 20,0	52,0	40x43,5
M40x1,5	8,0	24055d	18zu	18,0 – 14,0	51,0	43x47,3/40x43,5
		24055d	20zu	20,5 – 17,0	51,0	43x47,3/40x43,5
		24055d	25zu	25,0 – 20,0	51,0	43x47,3/40x43,5
		24055d	28zu	28,0 – 24,0	51,0	43x47,3/40x43,5
M40x1,5	9,0	24056d	32zu *	32,0 – 27,0	52,0	50x54
M50x1,5	10,0	25056d	32zu	32,0 – 27,0	52,0	54x58/50x54
		25056d	34zu	34,0 – 29,0	52,0	54x58/50x54
		25056d	36zu	36,0 – 32,0	52,0	54x58/50x54
M63x1,5	10,0	26358d	44zu **	44,0 – 39,0	54,0	68x74/64x69

\* Dichteinsatz kurz = Art.-Nr. Ek... \*\* Dichteinsatz aus Silikon HT nicht lieferbar.  
\* Sealing insert short = Art. no. Ek... \*\* Silicone HT sealing insert not available.

## UNI Klemm Dicht Kabelverschraubung

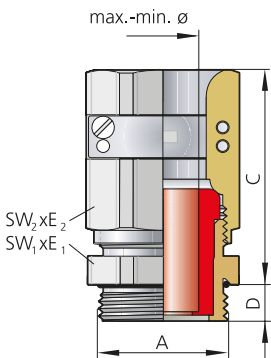
UNI Clamping Dicht cable gland

Fortsetzung von vorheriger Seite  
Continued from previous page

Anschlussgewinde/-länge Connection thread/length		Art.-Nr. Art. no.	Dichtbereich Sealing range	Bauhöhe Mounting height	Schlüsselweite Spanner width	
A	D mm	TPE TPE-V	max./min. ø mm	C mm	SW x E mm	
		Ausführung bitte ergänzen Please indicate product details				
		=				
		= p				
M75x1,5	15,0	275212d	47zu *	47,0 – 42,0	63,0	81x87
		275212d	52zu *	52,0 – 45,0	63,0	81x87
		275212d	55zu *	55,0 – 51,0	63,0	81x87
		275212d	58zu *	58,0 – 54,0	63,0	81x87
M80x2	15,0	280300d	57zu *	57,0 – 52,0	77,0	95x102
		280300d	64zu *	64,0 – 58,0	77,0	95x102
		280300d	70zu *	70,0 – 63,0	77,0	95x102
M80x2,0	15,0	280300d	70zu	70,0 – 63,0	77,0	95x102

\* Dichteinsatz aus Silikon HT nicht lieferbar.  
\* Silicone HT sealing insert not available.

**i** Verschraubung auch mit Pg-Anschlussgewinde erhältlich  
Gland also available with Pg connection thread

131100 | IT00400

**UNI Biegeschutz Dicht Kabelverschraubung**

UNI Dicht Bending protection cable gland



Abb. 1  
Fig. 1



Abb. 2  
Fig. 2

**Messing vernickelt**  
**Metrisches Anschlussgewinde nach EN 60423**  
**Mit O-Ring aus HNBR**  
**Schutzart IP 68 bis 10 bar**

*Brass, nickel-plated*  
*Metric connection thread according to EN 60423*  
*With o-ring made of HNBR*  
*Type of protection IP 68 up to 10 bar*

**i** Anschlussgewinde mit 15 mm Länge auf Anfrage  
*Long connection thread 15 mm on request*

Werkstoff Verschraubungskörper <i>Material gland body</i>	Ausführung/Farbe <i>Version/colour</i>	Werkstoff Dichteinsatz <i>Material sealing insert</i>	Farbe <i>Colour</i>	Temperaturbereich min./max. <i>Temperature range (min./max.)</i>
Messing Brass	Vernickelt (v) Nickel-plated (n)	TPE-V	Schwarz Black	-40 °C / +135 °C



Abb. 3  
Fig. 3

Anschlussgewinde/-länge <i>Connection thread/length</i>	Art.-Nr. <i>Art. no.</i>	Dichtbereich <i>Sealing range</i>	Bauhöhe <i>Mounting height</i>	Schlüsselweite <i>Spanner width</i>	SW <sub>1</sub> x E <sub>1</sub> /SW <sub>2</sub> x E <sub>2</sub> 
M12x1,5	21249dLp 4/V2	4,0– 2,5	53,0	14x15,5	50
	21249dLp 5/V2	5,0– 3,5	53,0	14x15,5	50
	21249dLp 6/V2	6,0– 4,5	53,0	14x15,5	50
	21249dLp 6,5/V2	6,5– 5,5	53,0	14x15,5	50
M16x1,5	21650dLp 5,5/V2	5,5– 4,0	66,0	18x20/17x18,9	50
	21650dLp 6/V2	6,0– 5,0	66,0	18x20/17x18,9	50
	21650dLp 7,5/V2	7,5– 5,5	66,0	18x20/17x18,9	50
M20x1,5	22051dLp 5,5/V2	5,5– 4,0	66,0	22x24,4/20x22,2	50
	22051dLp 6,5/V2	6,5– 5,0	66,0	22x24,4/20x22,2	50
	22052dLp 6,5/V2	6,5– 5,0	77,0	22x24,4/20x22,2	50
	22052dLp 7,5/V2	7,5– 6,0	77,0	22x24,4	50
	22051dLp 8/V2	8,0– 6,0	66,0	22x24,4/20x22,2	50
	22052dLp 8,5/V2	8,5– 7,0	77,0	22x24,4	50
	22051dLp 9,5/V2	9,5– 7,5	66,0	22x24,4/20x22,2	50
	22052dLp 10,5/V2	10,5– 8,0	77,0	22x24,4	50
M25x1,5	22553dLp 8/V2	8,0– 6,5	83,0	28x31,2/24x26,7	25
	22553dLp 9,5/V2	9,5– 7,5	83,0	28x31,2/24x26,7	25
	22553dLp 11/V2	11,0– 9,0	83,0	28x31,2/24x26,7	25
	22553dLp 13/V2	13,0– 10,5	83,0	28x31,2/24x26,7	25
M32x1,5	23254dLp 10/V2	10,0– 8,0	80,0	35x38,5/30x33,5	10
	23254dLp 11,5/V2	11,5– 9,5	80,0	35x38,5/30x33,5	10
	23254dLp 13,5/V2	13,5– 11,0	80,0	35x38,5/30x33,5	10
	23254dLp 15,5/V2	15,5– 13,0	80,0	35x38,5/30x33,5	10
	23254dLp 17,5/V2	17,5– 15,0	80,0	35x38,5/30x33,5	10
M40x1,5	24055dLp 19,5/V2	19,5– 16,0	84,0	43x47,3/40x43,5	10
	24055dLp 22/V2	22,0– 19,0	84,0	43x47,3/40x43,5	10
	24055dLp 24/V2	24,0– 21,0	84,0	43x47,3/40x43,5	10

12700 | JT00610

**i** Verschraubung auch mit Pg-Anschlussgewinde erhältlich  
*Gland also available with Pg connection thread*

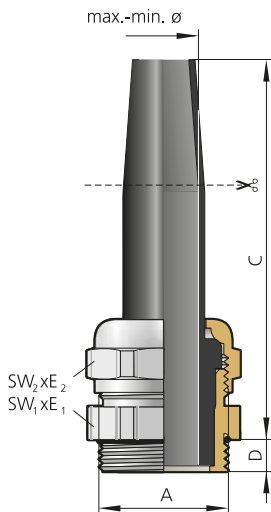
**i** Passende Gegenmuttern ab Seite 384  
*For matching lock nuts, see from page 384*

**UNI Biegeschutz Dicht Kabelverschraubung**

UNI Dicht Bending cable gland



Abb. 1  
Fig. 1



Abb. 2  
Fig. 2

**Polycarbonat, Farben: Grau (RAL 7035), Schwarz (RAL 9005)**  
**Metrisches Anschlussgewinde nach EN 60423**  
**Schutzart IP 68 bis 10 bar**

Polycarbonate, colours: grey (RAL 7035), black (RAL 9005)  
 Metric connection thread according to EN 60423  
 Type of protection IP 68 up to 10 bar

**i Schutzart IP 68 ausschließlich in Verbindung mit separat erhältlicher Flachdichtung auf Seite 407**  
 Type of protection IP 68 only in combination with separately available flat gasket on page 407

Werkstoff Verschraubungskörper Material gland body	Ausführung/Farbe Version/colour	Bestellschlüssel Art. no. supplement	Werkstoff Dichteinsatz Material sealing insert	Farbe Colour	Temperaturbereich min./max. Temperature range (min./max.)
PC	Grau Grey		TPE-V	Schwarz Black	-20 °C / +100 °C
PC	Schwarz Black	n	TPE-V	Schwarz Black	-20 °C / +100 °C



Abb. 3  
Fig. 3

Anschlussgewinde/-länge Connection thread/length		Art.-Nr. Art. no.	Dichtbereich Sealing range	Bauhöhe Mounting height	Schlüsselweite Spanner width
<b>A</b>	<b>D</b> mm	Ausführung bitte ergänzen Please indicate product details		<b>max./min. ø</b> mm	<b>C</b> mm
		Grau/Grey = Schwarz/Black = n			
M12x1,5	8,0	21249PC	Lp 4/V2	4,0 – 2,5	55,0
		21249PC	Lp 5/V2	5,0 – 3,5	55,0
		21249PC	Lp 6/V2	6,0 – 4,5	55,0
		21249PC	Lp 6,5/V2	6,5 – 5,5	55,0
M16x1,5	9,0	21650PC	Lp 5,5/V2	5,5 – 4,0	68,0
		21650PC	Lp 6/V2	6,0 – 5,0	68,0
		21650PC	Lp 7,5/V2	7,5 – 5,5	68,0
M20x1,5	9,0	22051PC	Lp 5,5/V2	5,5 – 4,0	75,0
		22051PC	Lp 6,5/V2	6,5 – 5,0	75,0
		22052PC	Lp 6,5/V2	6,5 – 5,0	80,0
		22052PC	Lp 7,5/V2	7,5 – 6,0	80,0
		22051PC	Lp 8/V2	8,0 – 6,0	75,0
		22052PC	Lp 8,5/V2	8,5 – 7,0	80,0
		22051PC	Lp 9,5/V2	9,5 – 7,5	75,0
		22052PC	Lp 10,5/V2	10,5 – 8,0	80,0
M25x1,5	9,0	22553PC	Lp 8/V2	8,0 – 6,0	85,0
		22553PC	Lp 9,5/V2	9,5 – 7,5	85,0
		22553PC	Lp 11/V2	11,0 – 9,0	85,0
		22553PC	Lp 13/V2	13,0 – 10,5	85,0
M32x1,5	11,0	23254PC	Lp 10/V2	10,0 – 8,0	82,0
		23254PC	Lp 11,5/V2	11,5 – 9,5	82,0
		23254PC	Lp 13,5/V2	13,5 – 11,0	82,0
		23254PC	Lp 15,5/V2	15,5 – 13,0	82,0
		23254PC	Lp 17,5/V2	17,5 – 15,0	82,0
M40x1,5	11,5	24055PC	Lp 19,5/V2	19,5 – 16,0	84,0
		24055PC	Lp 22/V2	22,0 – 19,0	84,0
		24055PC	Lp 24/V2	24,0 – 21,0	84,0

**i Passende Gegenmuttern ab Seite 384**  
 For matching lock nuts, see from page 384

**UNI Biegeschutz Dicht Kabelverschraubung**

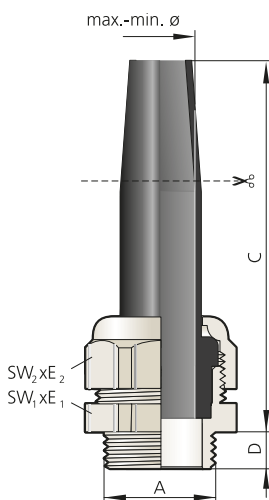
UNI Dicht Bending protection cable gland



Abb. 1  
Fig. 1

Abb. 2  
Fig. 2

**PVDF, Farben: Transparent, Blau (RAL 5015), Schwarz (RAL 9005)**  
**Metrisches Anschlussgewinde nach EN 60423**  
**Schutzart IP 68 bis 10 bar**

*PVDF, colours: transparent, blue (RAL 5015), black (RAL 9005)*  
*Metric connection thread according to EN 60423*  
*Type of protection IP 68 up to 10 bar*

**i Anschlussgewinde mit 15 mm Länge auf Anfrage**  
*Long connection thread 15 mm on request*

Werkstoff Verschraubungskörper <i>Material gland body</i>	Ausführung/Farbe <i>Version/colour</i>	Bestellschlüssel <i>Art. no. supplement</i>	Werkstoff Dichteinsatz <i>Material sealing insert</i>	Farbe <i>Colour</i>	Temperaturbereich min./max. <i>Temperature range (min./max.)</i>
PVDF	Transparent		TPE-V	Schwarz Black	-40 °C / +135 °C
PVDF	Blau Blue	a	TPE-V	Schwarz Black	-40 °C / +135 °C
PVDF	Schwarz Black	n	TPE-V	Schwarz Black	-40 °C / +135 °C



Abb. 3  
Fig. 3

Anschlussgewinde/-länge <i>Connection thread/length</i>		Art.-Nr. <i>Art. no.</i>	Dichtbereich <i>Sealing range</i>	Bauhöhe <i>Mounting height</i>	Schlüsselweite <i>Spanner width</i>		
		Ausführung bitte ergänzen <i>Please indicate product details</i>					
		Transparent =					
		Blau/Blue = a					
		Schwarz/Black = n					
A	D mm		max./min. ø mm	C mm	SW <sub>1</sub> x E <sub>1</sub> /SW <sub>2</sub> x E <sub>2</sub> mm		
M12x1,5	8,0	21249y	Lp 4/V2	4,0– 2,5	55,0	15x16,5	50
		21249y	Lp 5/V2	5,0– 3,5	55,0	15x16,5	50
		21249y	Lp 6/V2	6,0– 4,5	55,0	15x16,5	50
		21249y	Lp 6,5/V2	6,5– 5,5	55,0	15x16,5	50
M16x1,5	9,0	21650y	Lp 5,5/V2	5,5– 4,0	65,0	19x21,2	50
		21650y	Lp 6/V2	6,0– 4,5	65,0	19x21,2	50
		21650y	Lp 7,5/V2	7,5– 5,5	65,0	19x21,2	50
M20x1,5	9,0	22051y	Lp 5,5/V2	5,5– 4,0	75,0	24x26,5/22x24,4	50
		22051y	Lp 6,5/V2	6,5– 5,0	75,0	24x26,5/22x24,4	50
		22052y	Lp 6,5/V2	6,5– 5,0	80,0	24x26,5	50
		22052y	Lp 7,5/V2	7,5– 5,5	80,0	24x26,5	50
		22051y	Lp 8/V2	8,0– 6,0	75,0	24x26,5/22x24,4	50
		22052y	Lp 8,5/V2	8,5– 7,0	80,0	24x26,5	50
		22051y	Lp 9,5/V2	9,5– 7,5	75,0	24x26,5/22x24,4	50
		22051y	Lp 9,5/V2	9,5– 7,5	75,0	24x26,5	50
22052y	Lp10,5/V2	10,5– 8,0	72,0	24x26,5	50		
22052y	Lp10,5/V2	10,5– 8,0	80,0	24x26,5	50		
M25x1,5	9,0	22553y	Lp 8/V2	8,0– 6,0	85,0	29x31,5/27x29,5	25
		22553y	Lp 9,5/V2	9,5– 7,5	85,0	29x31,5/27x29,5	25
		22553y	Lp11/V2	11,0– 9,0	85,0	29x31,5/27x29,5	25
		22553y	Lp13/V2	13,0– 10,5	85,0	29x31,5/27x29,5	25
M32x1,5	11,0	23254y	Lp10/V2	10,0– 8,0	82,0	38x42/33x36,5	10
		23254y	Lp11,5/V2	11,5– 9,5	82,0	38x42/33x36,5	10
		23254y	Lp13,5/V2	13,5– 11,0	82,0	38x42/33x36,5	10
		23254y	Lp15,5/V2	15,5– 13,0	82,0	38x42/33x36,5	10
		23254y	Lp17,5/V2	17,5– 15,0	82,0	38x42/33x36,5	10
M40x1,5	11,5	24055y	Lp19,5/V2	19,5– 16,0	88,0	46x50/43x46	10
		24055y	Lp22/V2	22,0– 19,0	88,0	46x50/43x46	10
		24055y	Lp24/V2	24,0– 21,0	88,0	46x50/43x46	10

**i Schutzart IP 68 ausschließlich in Verbindung mit separat erhältlicher Flachdichtung auf Seite 407**  
*Type of protection IP 68 only in combination with separately available flat gasket on page 407*

**UNI Flex Dicht Kabelverschraubung**

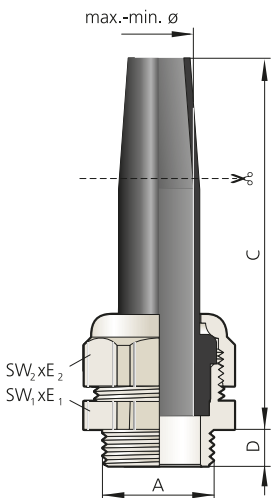
UNI Flex Dicht cable gland



Abb. 1  
Fig. 1



Abb. 2  
Fig. 2

**Messing vernickelt, Feder aus Edelstahl**  
**Metrisches Anschlussgewinde nach EN 60423**  
**Mit O-Ring aus HNBR/Silikon**  
**Schutzart IP 68 – statisch geprüft**  
**Zugentlastung bis Klasse A, EN 62444**

*Brass, nickel-plated, spring made of stainless steel*  
*Metric connection thread according to EN 60423*  
*With o-ring made of HNBR/silicone*  
*Type of protection IP 68 – statically tested*  
*Strain relief up to class A, EN 62444*

**i** **Flexible Leitungen an Robotern, Handbediengeräten, Fußschaltern etc. sind am Gerät besonderen Beanspruchungen unterworfen. Die UNI Flex gibt den Leitungen einen definierten Biegeradius und schützt vor Aderbruch.**  
*Flexible cables for robots, handheld terminals, foot switches, etc. are subjected to extreme stresses at the transition to the equipment. The UNI Flex provides these cables with a defined bending radius and protection against wire breakage.*

Werkstoff Verschraubungskörper Material gland body	Ausführung/Farbe Version/colour	Werkstoff Dichteinsatz Material sealing insert	Farbe Colour	Bestellschlüssel Art. no. supplement	Temperaturbereich min./max. Temperature range (min./max.)
Messing Brass	Vernickelt Nickel-plated	TPE	s. FC See CC		-40 °C / +130 °C
Messing Brass	Vernickelt Nickel-plated	TPE-V	Natur Natural	p	-40 °C / +135 °C
Messing Brass	Vernickelt Nickel-plated	Silikon HT Silicone HT	Schwarz Black	H	-55 °C / +200 °C



Abb. 3  
Fig. 3

Anschlussgewinde/-länge Connection thread/length		Art.-Nr. Art. no.	Dichtbereich Sealing range	Bauhöhe Mounting height	Schlüsselweite Spanner width		
Ausführung bitte ergänzen Please indicate product details							
A	D mm	TPE =	max./min. ø mm	C mm	SW <sub>1</sub> x E <sub>1</sub> /SW <sub>2</sub> x E <sub>2</sub> mm		
		TPE-V = p					
		Silikon HT/Silicone HT = H					
M16x1,5	6,0	21652dF	14.07V2	6,5 – 4,0	80,0	22x24,4	25
		21652dF	14.09V2	9,5 – 6,5	80,0	22x24,4	25
		21652dF	14.11V2	10,5 – 7,0	80,0	22x24,4	25
M20x1,5	6,5	22052dF	14.07V2	6,5 – 4,0	82,0	22x24,4	25
		22052dF	14.08V2	8,0 – 5,0	82,0	22x24,4	25
		22052dF	14.09V2	9,5 – 6,5	82,0	22x24,4	25
		22052dF	14.11V2	10,5 – 7,0	82,0	22x24,4	25
		22052dF	14.13V2	13,0 – 9,0	82,0	22x24,4	25
		22053dF	16.16V2	15,5 – 11,5	82,0	24x26,7	25
M25x1,5	7,5	22553dF	16.11V2	10,5 – 7,0	85,0	28x31,2/24x26,7	25
		22553dF	16.13V2	13,0 – 9,0	85,0	28x31,2/24x26,7	25
		22553dF	16.16V2	15,5 – 11,5	85,0	28x31,2/24x26,7	25
		22554dF	19.18V2	18,0 – 14,0	90,0	30x33,5	25
M32x1,5	8,0	23254dF	19.18V2	18,0 – 14,0	90,0	35x38,5/30x33,5	10

**i** **Verschraubung auch mit Pg-Anschlussgewinde erhältlich**  
*Gland also available with Pg connection thread*

**UNI Biege Zug Kabelverschraubung**

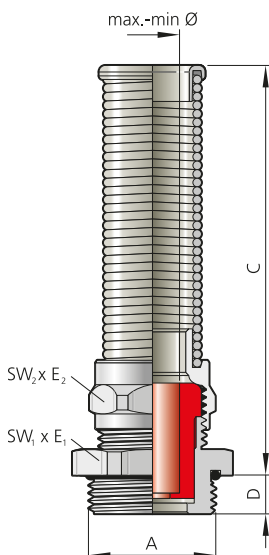
UNI Bending Strain relief cable gland



Abb. 1  
Fig. 1



Abb. 2  
Fig. 2

**Messing vernickelt**  
**Metrisches Anschlussgewinde nach EN 60423**  
**Mit O-Ring aus HNBR**  
**Schutzart IP 54**  
**Integrierte Zugentlastung – vibrationsfest**

*Brass, nickel-plated*  
*Metric connection thread according to EN 60423*  
*With o-ring made of HNBR*  
*Type of protection IP 54*  
*Integrated strain relief – vibration resistant*

**i Anschlussgewinde mit 15 mm Länge auf Anfrage**  
*Long connection thread 15 mm on request*

Werkstoff Verschraubungskörper Material gland body	Ausführung/Farbe Version/colour	Werkstoff Dichteinsatz Material sealing insert	Farbe Colour	Temperaturbereich min./max. Temperature range (min./max.)
Messing Brass	Vernickelt Nickel-plated	TPE-V	Schwarz Black	-20 °C / +100 °C



Abb. 3  
Fig. 3

Anschlussgewinde/-länge Connection thread/length <b>A</b>	D mm	Art.-Nr. Art. no.	Dichtbereich Sealing range max./min. ø mm	Bauhöhe Mounting height C mm	Schlüsselweite Spanner width SW <sub>1</sub> x E <sub>1</sub> / SW <sub>2</sub> x E <sub>2</sub> mm	50
M12x1,5	5,0	21250dLzp 7*	6,5 – 4,5	54,0	17x18,9	50
M16x1,5	6,0	21650dLzp 7	6,5 – 4,5	54,0	18x20/17x18,9	50
		21651dLzp 9*	9,0 – 6,0	63,0	20x22,2	50
		21652dLzp 9*	9,5 – 6,5	68,0	22x24,4	50
		21652dLzp11*	10,5 – 8,5	68,0	22x24,4	50
M20x1,5	6,5	22051dLzp 9	9,5 – 6,5	69,0	22x24,4/20x22,2	50
		22052dLzp 9	9,5 – 6,5	69,0	22x24,4	50
		22052dLzp11	10,5 – 8,5	69,0	22x24,4	50
		22053dLzp13*	13,0 – 9,0	77,0	24x26,7	25
		22054dLzp16*	15,5 – 13,0	78,0	30x33,5	10
M25x1,5	7,5	22553dLzp 9	9,5 – 6,5	73,0	28x31,2/24x26,7	25
		22553dLzp11	10,5 – 8,5	73,0	28x31,2/24x26,7	25
		22553dLzp13	13,0 – 9,0	73,0	28x31,2/24x26,7	25
		22554dLzp16*	15,5 – 13,0	78,0	30x33,5	10
M32x1,5	8,0	23254dLzp13	13,0 – 9,0	78,0	35x38,5/30x33,5	10
		23254dLzp16	15,5 – 13,0	78,0	35x38,5/30x33,5	10
		23254dLzp18	17,5 – 14,0	78,0	35x38,5/30x33,5	10
		23255dLzp21*	20,0 – 17,0	103,0	40x43,5	10
M40x1,5	8,0	24055dLzp21	20,0 – 17,0	104,0	43x47,3/40x43,5	10
		24055dLzp25	24,5 – 21,0	104,0	43x47,3/40x43,5	5

\* Dichteinsatz kurz = Art.-Nr. Ek...  
\* Sealing insert short = Art. no. Ek...

**i Verschraubung auch mit Pg-Anschlussgewinde erhältlich**  
*Gland also available with Pg connection thread*

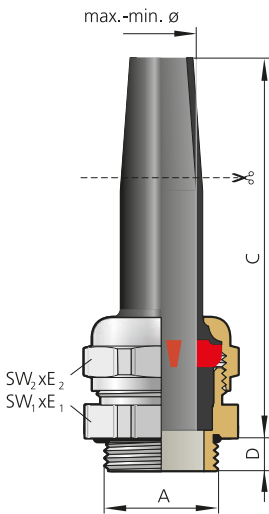
**i Passende Gegenmuttern ab Seite 384**  
*For matching lock nuts, see from page 384*

**UNI Biege Zug Kabelverschraubung**

UNI Bending Strain relief cable gland



Abb. 1  
Fig. 1

Abb. 2  
Fig. 2

**Polycarbonat, Farben: Grau (RAL 7035), Schwarz (RAL 9005)**  
**Metrisches Anschlussgewinde nach EN 60423**  
**Schutzart IP 54**  
**Integrierte Zugentlastung – vibrationsfest**

Polycarbonate, colours: grey (RAL 7035), black (RAL 9005)  
 Metric connection thread according to EN 60423  
 Type of protection IP 54  
 Integrated strain relief – vibration resistant

**i** **Passende Gegenmuttern ab Seite 384**  
 For matching lock nuts, see from page 384

Werkstoff Verschraubungskörper Material gland body	Ausführung/Farbe Version/colour	Bestellschlüssel Art. no. supplement	Werkstoff Dichteinsatz Material sealing insert	Farbe Colour	Temperaturbereich min./max. Temperature range (min./max.)
PC	Grau Grey		TPE-V	Schwarz Black	-20 °C / +100 °C
PC	Schwarz Black	n	TPE-V	Schwarz Black	-20 °C / +100 °C



Abb. 3  
Fig. 3

Anschlussgewinde/-länge Connection thread/length		Art.-Nr. Art. no.	Dichtbereich Sealing range	Bauhöhe Mounting height	Schlüsselweite Spanner width		
		Ausführung bitte ergänzen Please indicate product details					
A	D mm	Grau/Grey = Schwarz/Black = n	max./min. ø mm	C mm	SW <sub>1</sub> x E <sub>1</sub> /SW <sub>2</sub> x E <sub>2</sub> mm		
M12x1,5	8,0	21250PC	Lzp 7 *	6,5– 4,5	55,0	19x21,2	50
M16x1,5	9,0	21650PC	Lzp 7	6,5– 4,5	58,0	19x21,2	50
M16x1,5	8,5	21651PC	Lzp 9 *	9,0– 6,5	64,0	22x24,5	50
M20x1,5	9,0	22052PC	Lzp 9 *	9,5– 6,5	72,0	24x26,5	50
		22052PC	Lzp11 *	10,5– 8,5	72,0	24x26,5	50
		22053PC	Lzp13 *	13,0– 9,0	75,0	27x29,5	25
M25x1,5	9,0	22553PC	Lzp 9	9,5– 6,5	80,0	30x33/27x29,5	25
		22553PC	Lzp11	10,5– 7,0	80,0	30x33/27x29,5	25
		22553PC	Lzp13	13,0– 9,0	80,0	30x33/27x29,5	25
M25x1,5	11,0	22554PC	Lzp16 *	15,5– 13,0	80,0	33x36,5	10
		22554PC	Lzp18 *	17,5– 14,0	80,0	33x36,5	10
M32x1,5	11,0	23254PC	Lzp13	13,0– 9,0	80,0	36x39,5/33x36,5	10
		23254PC	Lzp16	15,5– 13,0	80,0	36x39,5/33x36,5	10
		23254PC	Lzp18	17,5– 14,0	80,0	36x39,5/33x36,5	10
		23255PC	Lzp21 *	20,5– 17,0	104,0	43x46	10
		23255PC	Lzp25 *	24,0– 20,0	104,0	43x46	10
M40x1,5	11,5	24055PC	Lzp21	20,5– 17,0	108,0	46x50/43x46,5	5
		24055PC	Lzp25	24,0– 20,0	108,0	46x50/43x46,5	5

\* Dichteinsatz kurz = Art.-Nr. Ek...  
 \* Sealing insert short = Art. no. Ek...

134400 | TT00700

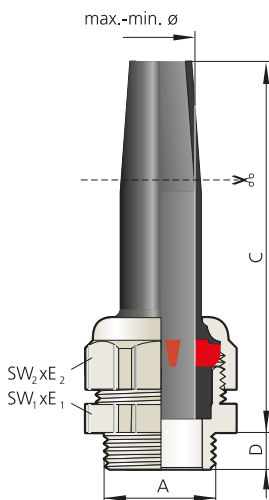

**UNI Biege Zug Kabelverschraubung**

UNI Bending Strain relief cable gland



Abb. 1  
Fig. 1

Abb. 2  
Fig. 2

**PVDF, Farben: Transparent, Blau (RAL 5015), Schwarz (RAL 9005)**  
**Metrisches Anschlussgewinde nach EN 60423**  
**Schutzart IP 54**  
**Integrierte Zugentlastung – vibrationsfest**

*PVDF, colours: transparent, blue (RAL 5015), black (RAL 9005)*  
*Metric connection thread according to EN 60423*  
*Type of protection IP 54*  
*Integrated strain relief – vibration resistant*

Werkstoff Verschraubungskörper Material gland body	Ausführung/Farbe Version/colour	Bestellschlüssel Art. no. supplement	Werkstoff Dichteinsatz Material sealing insert	Farbe Colour	Temperaturbereich min./max. Temperature range (min./max.)
PVDF	Transparent		TPE-V	Schwarz Black	-20 °C / +100 °C
PVDF	Blau Blue	a	TPE-V	Schwarz Black	-20 °C / +100 °C
PVDF	Schwarz Black	n	TPE-V	Schwarz Black	-20 °C / +100 °C



Abb. 3  
Fig. 3

Anschlussgewinde/-länge Connection thread/length		Art.-Nr. Art. no.	Dichtbereich Sealing range	Bauhöhe Mounting height	Schlüsselweite Spanner width	
A	D mm	Ausführung bitte ergänzen Please indicate product details		max./min. ø mm	C mm	SW <sub>1</sub> x E <sub>1</sub> /SW <sub>2</sub> x E <sub>2</sub> mm
		Transparent =				
		Blau/Blue = a				
		Schwarz/Black = n				
M16x1,5	9,0	21650y	Lzp 7	6,5– 4,5	55,0	19x21,2 50
M16x1,5	8,5	21651y	Lzp 9	9,0– 6,5	64,0	22x24,5 50
M20x1,5	9,0	22052y	Lzp 9	9,5– 6,5	72,0	24x26,5 50
		22052y	Lzp11	10,5– 8,5	72,0	24x26,5 50
		22053y	Lzp13	13,0– 9,0	76,0	27x29,5 25
M25x1,5	9,0	22553y	Lzp 9	9,5– 6,5	80,0	29x31,5/27x29,5 25
		22553y	Lzp11	10,5– 7,0	80,0	29x31,5/27x29,5 25
		22553y	Lzp13	13,0– 9,0	80,0	29x31,5/27x29,5 25
M25x1,5	11,0	22554y	Lzp16	15,5– 13,0	80,0	33x36,5 10
		22554y	Lzp18	17,5– 14,0	80,0	33x36,5 10
		22555y	Lzp21	20,0– 17,0	104,0	43x46 10
M32x1,5	11,0	23254y	Lzp13	13,0– 9,0	80,0	38x42/33x36,5 10
		23254y	Lzp16	15,5– 13,0	80,0	38x42/33x36,5 10
		23254y	Lzp18	17,5– 14,0	80,0	38x42/33x36,5 10
		23255y	Lzp21	20,0– 17,0	104,0	43x46 5
		23255y	Lzp25	24,0– 21,0	104,0	43x46 5
M40x1,5	11,5	24055y	Lzp21	20,0– 17,0	108,0	46x50/43x46,5 5
		24055y	Lzp25	24,0– 21,0	108,0	46x50/43x46,5 5

13500 | TPO2070

**Übersichtstabelle für die UNI Dicht Komponenten – M**
*Overview of UNI Dicht components – M*
**Messing vernickelt, Edelstahl 1.4305, Polycarbonat: Farbe Grau (RAL 7035), PVDF: Farbe Transparent, mit metr. Gewinde nach EN 60423, Schutzart IP 68 bis 10 bar**  
*Nickel-plated brass, stainless steel AISI 303, polycarbonate: colour grey (RAL7035), PVDF: colour transparent, with metric connection thread according to EN 60423, type of protection IP 68 up to 10 bar*

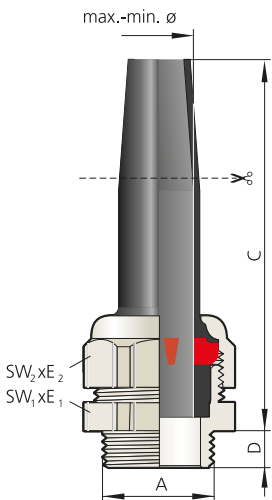
A	Messing vernickelt Brass, nickel-plated			Edelstahl 1.4305 Stainless steel AISI 303			Polycarbonat Polycarbonate
	Druckschraube (DS) Pressure screw (DS)	Doppelnippel (DN) Double nipple (DN)	Verschraubungs- körper (VK) Gland body (VK)	Druckschraube (DS) Pressure screw (DS)	Doppelnippel (DN) Double nipple (DN)	Verschraubungs- körper (VK) Gland body (VK)	Druckschraube (DS) Pressure screw (DS)
M4x0,7	DS 205d	DN 20405d	VK 20405d				
M6x0,75	DS 206d	DN 206d	VK 206d				
M8x1,0	DS 210208d	DN 208210d	VK 208210d				
M10x1,0	DS 149d	DN 21049d/1mm	VK 21049d/1mm	DS 149st	DN 21049d/1mm	VK 21049st/1mm	
M10x1,5	DS 149d	DN 21049d/1,5mm	VK 21049d/1,5mm				
M12x1,5	DS 149d	DN 21249d *	VK 21249d *	DS 149st	DN 21249st *	VK 21249st *	DS 149PC
M12x1,5	DS 150d	DN 21250d	VK 21250d				
M16x1,5	DS 150d	DN 21650d	VK 21650d	DS 150st	DN 21650st	VK 21650st	DS 150PC
M16x1,5	DS 151d	DN 21651d	VK 21651d	DS 151st	DN 21651st	VK 21651st	DS 151PC
M20x1,5	DS 152d	DN 22052d	VK 22052d	DS 152st	DN 22052st	VK 22052st	DS 152PC
M20x1,5	DS 153d	DN 22053d	VK 22053d	DS 153st	DN 22053st	VK 22053st	DS 153PC
M25x1,5	DS 153d	DN 22553d	VK 22553d	DS 153st	DN 22553st	VK 22553st	DS 153PC
M25x1,5	DS 154d18	DN 22554d	VK 22554d	DS 154st18	DN 22554st	VK 22554st	DS 154PC
M25x1,5	DS 154d21	DN 22554d	VK 22554d21	DS 154st21	DN 22554st	VK 22554st21	
M32x1,5	DS 154d18	DN 23254d	VK 23254d	DS 154st18	DN 23254st	VK 23254st	DS 154PC
M32x1,5	DS 154d21	DN 23254d	VK 23254d20	DS 154st21	DN 23254st	VK 23254st20	DS 154PC
M32x1,5	DS 155d	DN 23255d	VK 23255d	DS 155st	DN 23255st	VK 23255st	DS 155PC
M40x1,5	DS 155d	DN 24055d	VK 24055d	DS 155st	DN 24055st	VK 24055st	DS 155PC
M40x1,5	DS 156d	DN 24056d	VK 24056d	DS 156st	DN 24056st	VK 24056st	DS 156PC
M50x1,5	DS 156d	DN 25056d	VK 25056d	DS 156st	DN 25056st	VK 25056st	DS 156PC
M50x1,5	DS 157d	DN 25057d	VK 25057d	DS 157st	DN 25057st	VK 25057st	
M63x1,5	DS 158d	DN 26358d	VK 26358d	DS 158st	DN 26358st	VK 26358st	

\* Dichtensatz kurz = Art.-Nr. Ek... \*\* Werkstoff POM (Farbe Weiß), Temperaturbereich: -40 °C bis +110 °C.

\* Sealing insert short = Art. no. Ek... \*\* Material POM (white), temperature range: -40 °C up to +110 °C.

Polycarbonat Polycarbonate		PVDF PVDF			Dichteinsätze Sealing inserts			
Doppelnippel (DN) Double nipple (DN)	Verschraubungs- körper (VK) Gland body (VK)	Druckschraube (DS) Pressure screw (DS)	Doppelnippel (DN) Double nipple (DN)	Verschraubungs- körper (VK) Gland body (VK)	TPE	TPE-V	Silikon Silicone	TPE – geschlossen TPE – closed
					Ek204/1,6			
						Ek206kp 3		
					Ek210/ 4,5	Ek210p 4,5	E 210i 5 HF/HT	
					Ek149/ 7	Ek149p 7	E 149i 7 HF/HT	Ek149g
					Ek149/ 7	Ek149p 7	E 149i 7 HF/HT	Ek149g
DN 21249PC	VK 21249PC *	DS 149y	DN 21249y *	VK 21249y *	Ek149/ 7	Ek149p 7	E 149i 7 HF/HT	Ek149g
					Ek150/ 8	Ek150p 8	E 150i 8 HF/HT	Ek150g
					Ek150/ 9	Ek150p 9	E 150i 9 HF/HT	
DN 21650PC	VK 21650PC	DS 150y	DN 21650y	VK 21650y	E 150/ 7	E 150p 7	E 150i 7/HT	E 150g
					E 150/ 8	E 150p 8	E 150i 8/HT	
					E 150/ 9	E 150p 9	E 150i 9/HT	
DN 21651PC	VK 21651PC	DS 151y	DN 21651y	VK 21651y	Ek151/ 9	Ek151p 9	E 151i 9 HF/HT	Ek151g
					Ek151/11	Ek151p11	E 151i11 HF/HT	
DN 22052PC	VK 22052PC *	DS 152y	DN 22052y *	VK 22052y *	E 152/ 7	E 152p 7	E 152i 7/HT	E 152g
					E 152/ 8	E 152p 8	E 152i 8/HT	
					E 152/ 9	E 152p 9	E 152i 9/HT	
					E 152/11	E 152p11	E 152i11/HT	
					E 152/13	E 152p13	E 152i13/HT	
DN 22053PC	VK 22053PC	DS 153y	DN 22053y	VK 22053y	Ek153/11	Ek153p11	E 153i11 HF/HT	Ek153g
					Ek153/13	Ek153p13	E 153i13 HF/HT	
					Ek153/16	Ek153p16	E 153i16 HF/HT	
DN 22553PC	VK 22553PC	DS 153y	DN 22553y	VK 22553y	E 153/ 7	E 153p 7	E 153i 7/HT	E 153g
					E 153/ 8	E 153p 8	E 153i 8/HT	
					E 153/ 9	E 153p 9	E 153i 9/HT	
					E 153/11	E 153p11	E 153i11/HT	
					E 153/13	E 153p13	E 153i13/HT	
					E 153/16	E 153p16	E 153i16/HT	
DN 22554PC	VK 22554PC	DS 154y	DN 22554y	VK 22554y	Ek154/13	Ek154p13	E 154i13 HF/HT	Ek154g
					Ek154/16	Ek154p16	E 154i16 HF/HT	
					Ek154/18	Ek154p18	E 154i18 HF/HT	
		DS 154y	DN 22554y	VK 22554y	Ek154/20	Ek154p20	E 154i20 HF/HT	Ek154g
DN 23254PC	VK 23254PC	DS 154y	DN 23254y	VK 23254y	E 154/11	E 154p11	E 154i11/HT	E 154g
					E 154/13	E 154p13	E 154i13/HT	
					E 154/16	E 154p16	E 154i16/HT	
					E 154/18	E 154p18	E 154i18/HT	
DN 23254PC	VK 23254PC	DS 154y	DN 23254y	VK 23254y	E 154/20	E 154p20	E 154i20/HT	E 154g
DN 23255PC	VK 23255PC	DS 155y	DN 23255y	VK 23255y	Ek155/18	Ek155p18	E 155i18 HF/HT	Ek155g
					Ek155/20	Ek155p20	E 155i20 HF/HT	
					Ek155/25	Ek155p25	E 155i25 HF/HT	
					Ek155/28	Ek155p28	E 155i28 HF/HT	
DN 24055PC	VK 24055PC	DS 155y	DN 24055y	VK 24055y	E 155/16	E 155p16	E 155i16/HT	E 155g
					E 155/18	E 155p18	E 155i18/HT	
					E 155/20	E 155p20	E 155i20/HT	
					E 155/25	E 155p25	E 155i25/HT	
					E 155/28	E 155p28	E 155i28/HT	
DN 24056PC	VK 24056PC	DS 156y	DN 24056y	VK 24056y	Ek156/32	Ek156p32	E 156i32 HF/HT	Ek156g
					Ek156/34	Ek156p34	E 156i34 HF/HT	
					Ek156/36	Ek156p36	E 156i36 HF/HT	
DN 25056PC	VK 25056PC	DS 156y	DN 25056y	VK 25056y	E 156/32	E 156p32	E 156i32/HT	E 156g
					E 156/34	E 156p34	E 156i34/HT	
					E 156/36	E 156p36	E 156i36/HT	
		DS 157p **	DN 25057p **	VK 25057y **	E 157/40 HF	E 157p40 HF		Ek157g
		DS 158p **	DN 26358p **	VK 26358y **	E 158/44	E 158p44		E 158g

## Die bewährte UNI Dicht – Pg

*Tried and tested: UNI Dicht – Pg*



1

Abb. 1 – UNI Mehrfach mit geteiltem Dichteinsatz für konfektionierte Kabel  
Fig. 1 – UNI Multiple with split sealing insert for pre-assembled cables

### Anwendungsorientierte Individualität

Das PFLITSCH Kabelverschraubungssystem UNI Dicht erfüllt mit seiner Typenvielfalt viele weltweite Anforderungen an Kabel- und Leitungseinführungen. EMV- und Ex-Schutz, Lösungen für das Einführen von Flach- und Sonderkabeln (z. B. ASi-Bus) oder konfektionierten Kabeln durch geteilte Dichteinsätze oder mehrere Leitungen durch eine Mehrfach-Kabelverschraubung sind ebenso vorhanden wie Winkel- und Flanschverschraubungen. Auch Kombinationen mit Wellrohren und Schutzschläuchen für einen umfassenden mechanischen Kabelschutz sind möglich.

### Individualität in Metall und Kunststoff

Die UNI Dicht Kabelverschraubung besteht aus einem Verschraubungskörper und einem entsprechenden Dichteinsatz. Aus diesen Systemteilen stellt sich der Anwender seine individuelle Verschraubung zusammen – passend zu Einsatzbedingungen, Kabeldurchmessern, Umgebungstemperaturen, Anzahl der Kabel usw. Das ist Individualität in Serienqualität!

UNI Dicht gibt es in den aktuellen Größen Pg 7 bis Pg 48, weiterhin aber auch mit den gängigen metrischen Gewinden und mit internationalen Sondergewinden wie NPT- oder Zoll-Gewinden. Die Verschraubungskörper sind verfügbar in den Metallen Messing, Zink, Edelstahl und in den Kunststoffen PVDF und Polycarbonat. Die Dichteinsätze fertigt PFLITSCH aus den hochwertigen Materialien TPE, TPE-V und Silikon. Die eingesetzten Werkstoffe sind somit gegen eine Vielzahl unterschiedlichster Chemikalien resistent. Darüber hinaus erfüllen die Verschraubungen serienmäßig hohe Schutzarten bis zu IP 68 (bis 10 bar) bzw. IP 69.

### Baukastensystem für alle Anforderungen

Entsprechend den Einsatzanforderungen der Anwendung kann eine individuelle Kabelverschraubung zusammengestellt werden. Die benötigte Sonderkabelverschraubung mit Pg-Anschlussgewinde für Ihre Applikation ist nicht im Katalog aufgeführt? Viele Sonderlösungen aus dem UNI Dicht Baukastensystem mit metrischem Gewinde sind auf Anfrage auch mit Pg-Anschlussgewinde erhältlich. Auch das „Lochen nach Wunsch“ ist auf Anfrage möglich.

### Application-specific individuality

With its broad variety of types, the PFLITSCH cable gland system UNI Dicht fulfils all the EU requirements for cable entries. Solutions for EMC and explosion protection can be realised and flat and special cables (e.g. ASi bus) or pre-assembled cables fed through split sealing inserts. Multiple cable glands or elbow and flange glands can also be used. Combinations with corrugated conduits and protective hoses for comprehensive mechanical cable protection are likewise possible.

### Individuality in metal and plastic

The UNI Dicht gland comprises a gland body and an individual sealing insert. Users assemble their individual gland from these system components according to the operating conditions, cable diameters, ambient temperatures, number of cables, etc. We call this individuality in serial quality!

UNI Dicht currently comes in sizes Pg 7 to Pg 48 as well as with the widely used metric threads and or with special international threads such as NPT or imperial. The system is available in brass, zinc, stainless steel as well as in PVDF and polycarbonate. PFLITSCH manufactures the sealing inserts from high-grade TPE, TPE-V and silicone. The materials used are therefore resistant to a wide range of chemicals. Furthermore, UNI Dicht cable glands achieve high protection ratings of up to IP 68 (up to 10 bar) or IP 69 as standard.

### Modular system for all requirements

Individual cable glands can be assembled to meet specific application requirements. Is the special cable gland with Pg connection thread you need for your application not listed in the catalogue? Many special solutions from the UNI Dicht modular system with metric threads are also available with Pg connection threads on request, as are customised hole patterns.



PFLITSCH Produktsuche



PFLITSCH product search



Abb. 1 – Kabelverschraubung mit geschlossenem Dichteinsatz  
Fig. 1 – Cable gland with closed sealing insert

Abb. 2 – UNI Biegeschutz Dicht Kabelverschraubung  
Fig. 2 – UNI Dicht Bending protection cable gland

Abb. 3 – UNI Dicht Varianten in einer Schaltschrankanwendung  
Fig. 3 – UNI Dicht variants in a control cabinet application

**Das PFLITSCH System  
UNI Dicht Pg  
Aufbau der Artikelnummern**

*The PFLITSCH system  
UNI Dicht Pg  
Article number structure*

1 = Pg  
1 = Pg

Weitere Gewinde:  
Zoll, NPT  
*Other threads:  
Imperial, NPT*

**Anschluss-  
gewinde:**

*Connection thread:*

49 = Pg 7  
50 = Pg 9  
51 = Pg 11  
52 = Pg 13,5  
53 = Pg 16  
54 = Pg 21  
55 = Pg 29  
56 = Pg 36  
57 = Pg 42  
58 = Pg 48

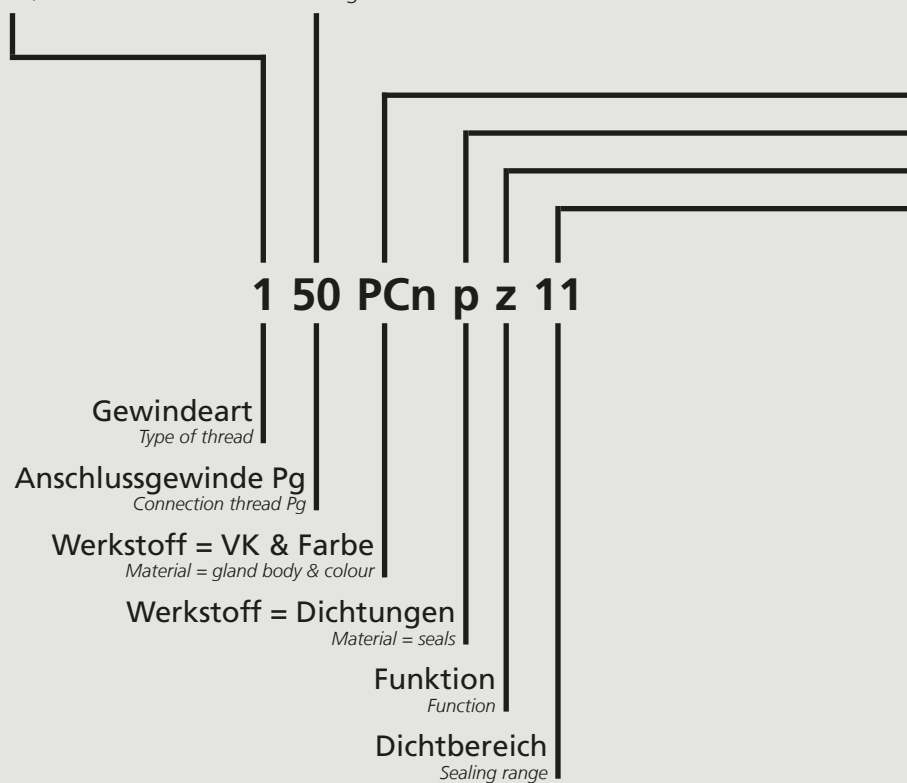

## Werkstoffe Verschraubungskörper:

*Materials gland body:*

d	= Messing vernickelt <i>Brass, nickel-plated</i>
st	= Edelstahl 1.4305 <i>AISI 303</i>
PC	= Polycarbonat <i>Polycarbonate</i>
PCn	= Polycarbonat Farbe Schwarz <i>Polycarbonate Colour black</i>
PCw	= Polycarbonat Winkel <i>Polycarbonate Elbow</i>
y	= PVDF Farbe Transparent <i>Colour transparent</i>
ya	= PVDF Farbe Blau <i>Colour blue</i>
yn	= PVDF Farbe Schwarz <i>Colour black</i>
VW	= Zink Winkel <i>Zinc Elbow</i>

## Werkstoffe Dichtungen:

*Materials seals:*

–	= TPE
p	= TPE-V
H	= Silikon HT <i>Silicone HT</i>
B	= T80s
Bi	= S55

## Funktion:

### *Function:*

–	= Standard-Dichteinsatz <i>Standard sealing insert</i>
z	= Zugentlastung <i>Strain relief</i>
e	= Entstörung <i>Interference suppression</i>
ez	= Entstörung & Zugentlastung <i>Interference suppression &amp; strain relief</i>
L	= Biegeschutz <i>Bending protection</i>
Lz	= Biegeschutz & Zugentlastung <i>Bending protection &amp; strain relief</i>
m	= Mehrfach <i>Multiple</i>
mK	= Multifunktion (Stecker) <i>Multi-function (connector)</i>

s	= Schlauch <i>Hose</i>
f...g	= flach, gerundet <i>Flat, rounded</i>
f...v	= flach, oval <i>Flat, oval</i>
f...e	= flach, eckig <i>Flat, angular</i>
F	= Flex <i>Flex</i>
W	= Wellrohr <i>Corrugated conduit</i>
UL	= UL-Schlauchverschraubung <i>UL hose gland</i>
g	= geschlossen <i>Closed</i>

## Dichtbereich:

*Sealing range:*

7	= 6,5 – 4,0
8	= 8,0 – 5,0
9	= 9,5 – 6,5
11	= 10,5 – 7,0
13	= 13,0 – 9,0
16	= 15,5 – 11,5
18	= 18,0 – 14,0
20	= 20,5 – 17,0
25	= 25,0 – 20,0
28	= 28,0 – 24,0
32	= 32,0 – 27,0
34	= 34,0 – 29,0
36	= 36,0 – 32,0
40	= 40,0 – 36,0
44	= 44,0 – 39,0

## Das PFLITSCH System UNI Dicht – Komponenten

The PFLITSCH system  
UNI Dicht – components

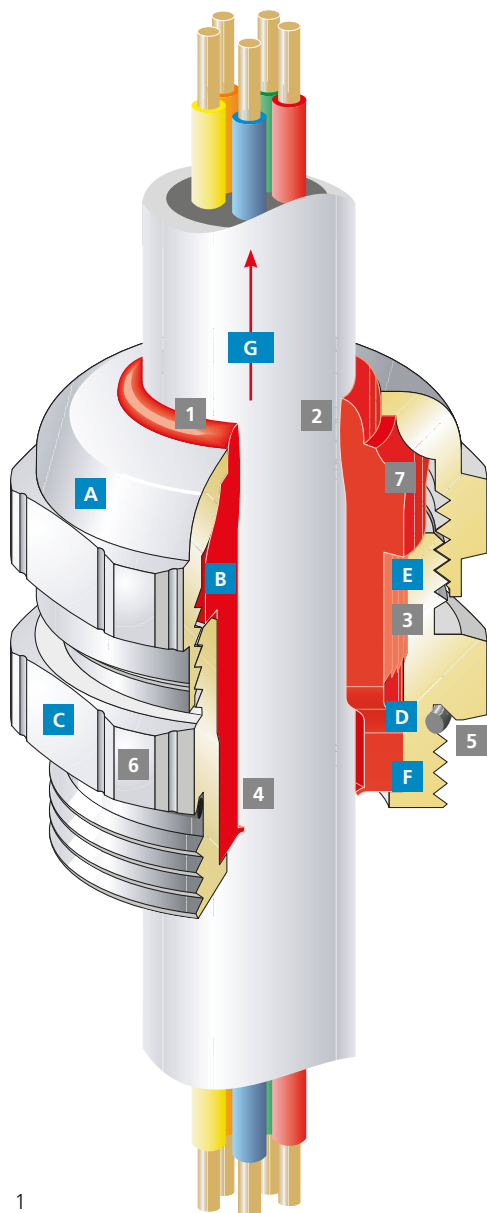

1

Abb. 1 – Querschnitt einer UNI Dicht Kabelverschraubung  
Fig. 1 – Cross section of a UNI Dicht cable gland

### Komponenten:

Components:

- A** Druckschraube (DS)  
Pressure screw (DS)
  - Messing/Messing bleifrei, galvanisch vernickelt  
Brass/lead-free brass, galvanically nickel-plated
  - Edelstahl 1.4305  
Stainless steel AISI 303
  - Edelstahl 1.4571  
Stainless steel AISI 316 Ti
  - Kunststoff: Polycarbonat (PC)  
Plastic: Polycarbonate (PC)
  - Hochleistungskunststoff PVDF  
High-performance plastic PVDF
  
- B** Dichteinsatz (E, Ek)  
Sealing insert (E, Ek)
  - TPE
  - TPE-V
  - Silikon HT  
Silicone HT
  
- C** Doppelnippel (DN)  
Double nipple (DN)
  - Messing/Messing bleifrei, galvanisch vernickelt  
Brass/lead-free brass, galvanically nickel-plated
  - Edelstahl 1.4305  
Stainless steel AISI 303
  - Edelstahl 1.4571  
Stainless steel AISI 316 Ti
  - Kunststoff: Polycarbonat (PC)  
Plastic: Polycarbonate (PC)
  - Hochleistungskunststoff PVDF  
High-performance plastic PVDF
  
- D** O-Ring  
O-ring  
Bei metallischen Doppelnippeln (DN)  
With metal double nipple (DN)w
  - Kautschuk (HNBR)  
Rubber (HNBR)
  - Silikon HT  
Silicone HT
  
- E** Kopfgewinde  
Head thread
  - Standard
  - Erweitert – für Varianten mit größeren Dichtbereichen  
Extended – for variants with larger sealing ranges
  - Reduziert (auf Anfrage) – für kompakte Bauformen und kleine Kabeldurchmesser  
Reduced (on request) – for compact designs and small cable diameters
  
- F** Anschlussgewinde  
Connection thread
  - Metrisch  
Metric
  - Pg
  - NPT  
NPT
  - Zoll  
Imperial
  - Standard/Lang  
Standard/long
  
- G** Sehr hohe Auszugskräfte (EN 62444, bis Klasse A)  
High strain relief (EN 62444 up to class A)



### Vorteile:

#### Advantages:

- 1 - IP 68 bis 10 bar zum Kabel und zur Druckschraube  
*IP 68 up to 10 bar to the cable and pressure screw*
- 2 - Radialsymmetrisch weiche Kabelpressung  
*Radially symmetrical soft cable pressing*  
- Großflächige Zugentlastung  
*Strain relief over a large area*  
- Keine Beschädigung des Kabels  
*No damage to the cable*
- 3 - Verdrehschutz durch Rändelung am Doppelnippel (DN) und Dichteinsatz (E, EK)  
*Anti-twist protection with knurling of the double nipple (DN) and sealing insert (E, EK)*  
- Kein Verdrehen des Kabels bei Montage/Demontage  
*No twisting of the cable during installation/disassembly*
- 4 - IP 54 durch Membrane am Dichteinsatz ohne Anziehen der Druckschraube (DS)  
*IP 54 due to diaphragms on the sealing insert without tightening the pressure screw (DS)*
- 5 - Nutgeführter O-Ring sichert Abdichtung zum Gehäuse  
*O-ring held in the groove provides seal to the enclosure*
- 6  Das PFLITSCH Markenzeichen – zwölf Riefen als Zeichen für Innovation und Qualität  
*The PFLITSCH trademark – twelve grooves as a sign of innovation and quality*
- 7 - Farbcodierung der TPE-Dichteinsätze (E, EK), zur eindeutigen Zuordnung der Dichteinsätze zu den verwendeten Kabeldurchmessern  
*Colour coding of the TPE sealing inserts (E, EK) for clear assignment of the inserts to the cable diameters used*  
- Erhältlich in verschiedenen Materialien  
*Available in different materials*



### UNI Farbcode (FC) für TPE-Dichteinsätze

UNI colour code (CC) for TPE sealing inserts

	Farbcode FC <i>Colour code CC</i>	Dichtbereich <i>Sealing range</i> max./min. Ø	Anschlussgewinde <i>Connection thread</i>
	<b>Gelb</b> <i>Yellow</i>	(ge) 6,5 – 4,0	M10, M12, M16, M20, M25 Pg 7, Pg 9, Pg 11, Pg 13,5, Pg 16
	<b>Grau</b> <i>Grey</i>	(gu) 8,0 – 5,0	M12, M16, M20, M25 Pg 9, Pg 11, Pg 13,5, Pg 16
	<b>Schwarz</b> <i>Black</i>	(sw) 9,5 – 6,5	M12, M16, M20, M25 Pg 9, Pg 11, Pg 13,5, Pg 16
	<b>Grün</b> <i>Green</i>	(gr) 10,5 – 7,0	M16, M20, M25, M32 Pg 11, Pg 13,5, Pg 16, Pg 21
	<b>Rot</b> <i>Red</i>	(rt) 13,0 – 9,0	M16, M20, M25, M32 Pg 9, Pg 13,5, Pg 16, Pg 21
	<b>Weiß</b> <i>White</i>	(ws) 15,5 – 11,5	M20, M25, M32, M40 Pg 16, Pg 21, Pg 29
	<b>Blau</b> <i>Blue</i>	(bl) 18,0 – 14,0	M20, M25, M32, M40 Pg 16, Pg 21, Pg 29
	<b>Braun</b> <i>Brown</i>	(br) 20,5 – 17,0	M20, M25, M32, M40 Pg 13,5, Pg 16, Pg 21, Pg 29
	<b>Orange</b> <i>Orange</i>	(or) 25,0 – 20,0	M32, M40 Pg 16, Pg 21, Pg 29
	<b>Hellgelb</b> <i>Light yellow</i>	(hg) 28,0 – 24,0	M32, M40 Pg 16, Pg 21, Pg 29
	<b>Anthrazit</b> <i>Anthracite</i>	(an) 32,0 – 27,0	M32, M40, M50 Pg 21, Pg 29, Pg 36
	<b>Hellblau</b> <i>Light blue</i>	(hb) 34,0 – 29,0	M32, M40, M50 Pg 21, Pg 29, Pg 36
	<b>Rosa</b> <i>Pink</i>	(rs) 36,0 – 32,0	M32, M40, M50 Pg 21, Pg 29, Pg 36
	<b>Weiß</b> <i>White</i>	(ws) 40,0 – 36,0	M50 Pg 36, Pg 42
	<b>Weiß</b> <i>White</i>	(ws) 44,0 – 39,0	M63 Pg 48

**UNI Dicht Pg-Kabelverschraubung**

UNI Dicht Pg cable gland



Abb. 1  
Fig. 1



Abb. 2  
Fig. 2

**Messing vernickelt**  
**Pg-Anschlussgewinde**  
**Mit O-Ring aus HNBR**  
**Schutzart IP 68 bis 10 bar**  
**Zugentlastung bis Klasse A, EN 62444**

Brass, nickel-plated  
Pg connection thread  
With o-ring made of HNBR  
Type of protection IP 68 up to 10 bar  
Strain relief up to class A, EN 62444

**i Gewinde-Varianten:** Standard-Maß D = Art.-Nr. 15...  
Thread variants: 15 mm Länge = Art.-Nr. 18...  
Standard size D = Art. no. 15...  
15 mm length = Art. no. 18...

Werkstoff Verschraubungskörper Material gland body	Ausführung/Farbe Version/colour	Werkstoff Dichteinsatz Material sealing insert	Farbe Colour	Bestellschlüssel Art. no. supplement	Temperaturbereich min./max. Temperature range (min./max.)
Messing Brass	Vernickelt Nickel-plated	TPE	s. FC See CC	d	-40 °C / +130 °C
Messing Brass	Vernickelt Nickel-plated	TPE-V	Natur Natural	p	-40 °C / +135 °C
Messing Brass	Vernickelt Nickel-plated	Silikon HT Silicone HT	Schwarz Black	H	-55 °C / +200 °C



Abb. 3  
Fig. 3



Abb. 4 – Ausführung lang, D = 15 mm  
Fig. 4 – Long version, D = 15 mm

Anschlussgewinde/-länge Connection thread/length	Art.-Nr. Art. no.	Dichtbereich Sealing range	Bauhöhe Mounting height	Schlüsselweite Spanner width
Ausführung bitte ergänzen Please indicate product details				
	TPE = d			
	TPE-V = p			
	Silikon HT/Silicone HT = H			
<b>A</b>	<b>D</b> mm	<b>max./min. ø</b> mm	<b>C</b> mm	<b>SW x E</b> mm
Pg 7	5,0	149 7 6,5– 4,0	20,0	14x15,5 50
Pg 9	6,0	150 7 6,5– 4,0	20,0	17x18,9 50
		150 8 8,0– 5,0	20,0	17x18,9 50
		150 9 9,5– 6,5	20,0	17x18,9 50
Pg 11	6,0	151 7 6,5– 4,0	20,0	20x22,2 50
		151 8 8,0– 5,0	20,0	20x22,2 50
		151 9 9,5– 6,5	20,0	20x22,2 50
		151 11 10,5– 7,0	20,0	20x22,2 50
Pg 13,5	6,5	152 7 6,5– 4,0	21,0	22x24,4 50
		152 8 8,0– 5,0	21,0	22x24,4 50
		152 9 9,5– 6,5	21,0	22x24,4 50
		152 11 10,5– 7,0	21,0	22x24,4 50
		152 13 13,0– 9,0	21,0	22x24,4 50
Pg 16	6,5	153 7 6,5– 4,0	21,0	24x26,7 50
		153 8 8,0– 5,0	21,0	24x26,7 50
		153 9 9,5– 6,5	21,0	24x26,7 50
		153 11 10,5– 7,0	21,0	24x26,7 50
		153 13 13,0– 9,0	21,0	24x26,7 50
		153 16 15,5– 11,5	21,0	24x26,7 50
Pg 21	7,0	154 11 10,5– 7,0	25,0	30x33,5 25
		154 13 13,0– 9,0	25,0	30x33,5 25
		154 16 15,5– 11,5	25,0	30x33,5 25
		154 18 18,0– 14,0	25,0	30x33,5 25
		154 20 20,5– 17,0	25,0	30x33,5 25
Pg 29	8,0	155 13 * 13,0– 9,0	28,0	40x43,5 10
		155 16 15,5– 11,5	28,0	40x43,5 10
		155 18 18,0– 14,0	28,0	40x43,5 10
		155 20 20,5– 17,0	28,0	40x43,5 10
		155 25 25,0– 20,0	28,0	40x43,5 10
		155 28 28,0– 24,0	28,0	40x43,5 10
Pg 36	9,0	156 32 32,0– 27,0	28,0	50x54 10
		156 34 34,0– 29,0	28,0	50x54 10
		156 36 36,0– 32,0	28,0	50x54 10
Pg 42	10,0	157 36 * 36,0– 32,0	30,0	57x61 5
		157 40 * 40,0– 36,0	30,0	57x61 5
Pg 48	10,0	158 44 * 44,0– 39,0	30,0	64x69 5

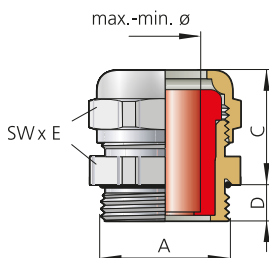
\* Dichteinsatz aus Silikon HT nicht lieferbar.  
\* Silicone HT sealing insert not available.

**i Passende Gegenmuttern ab Seite 384**  
For matching lock nuts, see from page 384

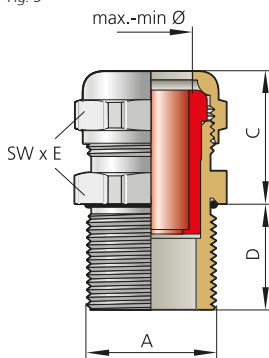
Technische Details und Informationen zu Zulassungen ab Seite 419  
For technical details and information on certifications, see page 419 ff.

**UNI Dicht Pg-Kabelverschraubung**

UNI Dicht Pg cable gland



Abb. 1  
Fig. 1



Abb. 2  
Fig. 2

**Edelstahl 1.4305**  
**Pg-Anschlussgewinde**  
**Mit O-Ring aus Silikon**  
**Schutzart IP 68 bis 10 bar**  
**Zugentlastung bis Klasse A, EN 62444**

Stainless steel AISI 303  
Pg connection thread  
With o-ring made of silicone  
Type of protection IP 68 up to 10 bar  
Strain relief up to class A, EN 62444

**i** Anschlussgewinde mit 15 mm Länge auf Anfrage  
Long connection thread 15 mm on request

Werkstoff Verschraubungskörper Material gland body	Ausführung/Farbe Version/colour	Werkstoff Dichteinsatz Material sealing insert	Farbe Colour	Bestellschlüssel Art. no. supplement	Temperaturbereich min./max. Temperature range (min./max.)
VA 1.4305 AISI 303	Blank	TPE	s. FC See CC		-40 °C / +130 °C
VA 1.4305 AISI 303	Blank	TPE-V	Natur Natural	p	-40 °C / +135 °C
VA 1.4305 AISI 303	Blank	Silikon HT Silicone HT	Schwarz Black	H	-55 °C / +200 °C



Abb. 3  
Fig. 3

Anschlussgewinde/-länge Connection thread/length		Art.-Nr. Art. no.	Dichtbereich Sealing range	Bauhöhe Mounting height	Schlüsselweite Spanner width	
Ausführung bitte ergänzen Please indicate product details						
<b>A</b>	<b>D</b> mm	TPE = TPE-V = p Silikon HT/Silicone HT = H	<b>max./min. ø</b> mm	<b>C</b> mm	<b>SW x E</b> mm	
Pg 7	5,0	149st	7	6,5 – 4,0	20,0	14x15,5 50
Pg 9	6,0	150st	7	6,5 – 4,0	20,0	17x18,9 50
		150st	8	8,0 – 5,0	20,0	17x18,9 50
Pg 11	6,0	150st	9	9,5 – 6,5	20,0	17x18,9 50
		151st	7	6,5 – 4,0	20,0	22x24,4 50
		151st	8 *	8,0 – 5,0	20,0	22x24,4 50
		151st	9	9,5 – 6,5	20,0	22x24,4 50
Pg 13,5	6,5	151st	11	10,5 – 7,0	20,0	22x24,4 50
		152st	7	6,5 – 4,0	21,0	22x24,4 50
		152st	8	8,0 – 5,0	21,0	22x24,4 50
		152st	9	9,5 – 6,5	21,0	22x24,4 50
		152st	11	10,5 – 7,0	21,0	22x24,4 50
Pg 16	6,5	152st	13	13,0 – 9,0	21,0	22x24,4 50
		153st	7	6,5 – 4,0	21,0	24x26,7 50
		153st	8	8,0 – 5,0	21,0	24x26,7 50
		153st	9	9,5 – 6,5	21,0	24x26,7 50
		153st	11	10,5 – 7,0	21,0	24x26,7 50
		153st	13	13,0 – 9,0	21,0	24x26,7 50
Pg 21	7,0	153st	16	15,5 – 11,5	21,0	24x26,7 50
		154st	11	10,5 – 7,0	26,0	30x33,5 25
		154st	13	13,0 – 9,0	26,0	30x33,5 25
		154st	16	15,5 – 11,5	26,0	30x33,5 25
		154st	18	18,0 – 14,0	26,0	30x33,5 25
Pg 29	8,0	154st	20	20,5 – 17,0	26,0	30x33,5 25
		155st	13 *	13,0 – 9,0	28,0	41x44,5 10
		155st	16	15,5 – 11,5	28,0	41x44,5 10
		155st	18	18,0 – 14,0	28,0	41x44,5 10
		155st	20	20,5 – 17,0	28,0	41x44,5 10
		155st	25	25,0 – 20,0	28,0	41x44,5 10
Pg 36	9,0	155st	28	28,0 – 24,0	28,0	41x44,5 10
		156st	32	32,0 – 27,0	28,0	50x54 10
		156st	34	34,0 – 29,0	28,0	50x54 10
Pg 42	10,0	156st	36	36,0 – 32,0	28,0	50x54 10
		157st	36 *	36,0 – 32,0	30,0	60x65 5
Pg 48	10,0	157st	40 *	40,0 – 36,0	30,0	60x65 5
		158st	44 *	44,0 – 39,0	30,0	65x70 5

\* Dichteinsatz aus Silikon HT nicht lieferbar.  
\* Silicone HT sealing insert not available.

**i** Passende Gegenmuttern ab Seite 384  
For matching lock nuts, see from page 384

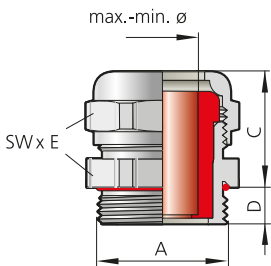
**UNI Dicht Pg-Kabelverschraubung**

UNI Dicht Pg cable gland



Abb. 1  
Fig. 1



Abb. 2  
Fig. 2

**Edelstahl 1.4571**  
**Pg-Anschlussgewinde**  
**Mit O-Ring aus Silikon**  
**Schutzart IP 68 bis 10 bar**  
**Zugentlastung bis Klasse A, EN 62444**

*Stainless steel AISI 316Ti*  
*Pg connection thread*  
*With o-ring made of silicone*  
*Type of protection IP 68 up to 10 bar*  
*Strain relief up to class A, EN 62444*

**i** Anschlussgewinde mit 15 mm Länge auf Anfrage  
*Long connection thread 15 mm on request*

Werkstoff Verschraubungskörper <i>Material gland body</i>	Ausführung/Farbe <i>Version/colour</i>	Werkstoff Dichteinsatz <i>Material sealing insert</i>	Farbe <i>Colour</i>	Bestellschlüssel <i>Art. no. supplement</i>	Temperaturbereich min./max. <i>Temperature range (min./max.)</i>
VA 1.4571 AISI 316Ti	Blank	TPE	s. FC See CC		-40 °C / +130 °C
VA 1.4571 AISI 316Ti	Blank	TPE-V	Natur Natural	p	-40 °C / +135 °C
VA 1.4571 AISI 316Ti	Blank	Silikon HT Silicone HT	Schwarz Black	H	-55 °C / +200 °C



Abb. 3  
Fig. 3

Anschlussgewinde/-länge <i>Connection thread/length</i>		Art.-Nr. <i>Art. no.</i>	Dichtbereich <i>Sealing range</i>	Bauhöhe <i>Mounting height</i>	Schlüsselweite <i>Spanner width</i>
Ausführung bitte ergänzen <i>Please indicate product details</i>					
<b>A</b>	<b>D</b> mm	TPE = TPE-V = p Silikon HT/Silicone HT = H	<b>max./min. ø</b> mm	<b>C</b> mm	<b>SW x E</b> mm
Pg 7	5,0	149st 7 V4A	6,5 – 4,0	20,0	14x15,5 50
Pg 9	6,0	150st 7 V4A	6,5 – 4,0	20,0	17x18,9 50
		150st 8 V4A	8,0 – 5,0	20,0	17x18,9 50
		150st 9 V4A	9,5 – 6,5	20,0	17x18,9 50
Pg 11	6,0	151st 7 V4A	6,5 – 4,0	20,0	22x24,4 50
		151st 9 V4A	8,0 – 5,0	20,0	22x24,4 50
		151st 9 V4A	9,5 – 6,5	20,0	22x24,4 50
		151st 11V4A	10,5 – 7,0	20,0	22x24,4 50
Pg 13,5	6,5	152st 7 V4A	6,5 – 4,0	21,0	22x24,4 50
		152st 8 V4A	8,0 – 5,0	21,0	22x24,4 50
		152st 9 V4A	9,5 – 6,5	21,0	22x24,4 50
		152st 11V4A	10,5 – 7,0	21,0	22x24,4 50
		152st 13V4A	13,0 – 9,0	21,0	22x24,4 50
Pg 16	6,5	153st 7 V4A	6,5 – 4,0	21,0	24x26,7 50
		153st 8 V4A	8,0 – 5,0	21,0	24x26,7 50
		153st 9 V4A	9,5 – 6,5	21,0	24x26,7 50
		153st 11V4A	10,5 – 7,0	21,0	24x26,7 50
		153st 13V4A	13,0 – 9,0	21,0	24x26,7 50
		153st 16V4A	15,5 – 11,5	21,0	24x26,7 50
Pg 21	7,0	154st 11V4A	10,5 – 7,0	26,0	30x33,5 25
		154st 13V4A	13,0 – 9,0	26,0	30x33,5 25
		154st 16V4A	15,5 – 11,5	26,0	30x33,5 25
		154st 18V4A	18,0 – 14,0	26,0	30x33,5 25
		154st 20V4A	20,5 – 17,0	26,0	30x33,5 25
Pg 29	8,0	155st 13V4A *	13,0 – 9,0	28,0	41x44,5 10
		155st 16V4A	15,5 – 11,5	28,0	41x44,5 10
		155st 18V4A	18,0 – 14,0	28,0	41x44,5 10
		155st 20V4A	20,5 – 17,0	28,0	41x44,5 10
		155st 25V4A	25,0 – 20,0	28,0	41x44,5 10
		155st 28V4A	28,0 – 24,0	28,0	41x44,5 10
Pg 36	9,0	156st 32V4A	32,0 – 27,0	28,0	50x54 10
		156st 34V4A	34,0 – 29,0	28,0	50x54 10
		156st 36V4A	36,0 – 32,0	28,0	50x54 10
Pg 42	10,0	157st 36V4A *	36,0 – 32,0	30,0	60x65 5
		157st 40V4A *	40,0 – 36,0	30,0	60x65 5
Pg 48	10,0	158st 44V4A *	44,0 – 39,0	30,0	65x70 5

\* Dichteinsatz aus Silikon HT nicht lieferbar.  
\* Silicone HT sealing insert not available.

**i** Passende Gegenmuttern ab Seite 384  
*For matching lock nuts, see from page 384*

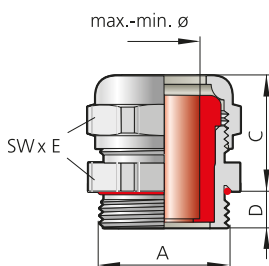
Technische Details und Informationen zu Zulassungen ab Seite 419  
*For technical details and information on certifications, see page 419 ff.*

**UNI Dicht Pg-Kabelverschraubung**

UNI Dicht Pg cable gland



Abb. 1  
Fig. 1

Abb. 2  
Fig. 2

**Polycarbonat, Farben: Grau (RAL 7035), Schwarz (RAL 9005)**  
**Pg-Anschlussgewinde**  
**Schutzart IP 68 bis 10 bar**

Polycarbonate, colour: grey (RAL 7035), black (RAL 9005)  
Pg connection thread  
Type of protection IP 68 up to 10 bar

**i** **Passende Gegenmuttern ab Seite 384**  
For matching lock nuts, see from page 384

Werkstoff Verschraubungskörper Material gland body	Ausführung/Farbe Version/colour	Bestellschlüssel Art. no. supplement	Werkstoff Dichteinsatz Material sealing insert	Farbe Colour	Bestellschlüssel Art. no. supplement	Temperaturbereich min./max. Temperature range (min./max.)
PC	Grau Grey	PC	TPE	s. FC See CC		-20 °C / +100 °C
PC	Grau Grey	PC	TPE-V	Natur Natural	p	-20 °C / +100 °C
PC	Grau Grey	PC	Silikon HT Silicone HT	Schwarz Black	H	-20 °C / +100 °C
PC	Schwarz Black	PCn	TPE	s. FC See CC		-20 °C / +100 °C
PC	Schwarz Black	PCn	TPE-V	Natur Natural	p	-20 °C / +100 °C
PC	Schwarz Black	PCn	Silikon HT Silicone HT	Schwarz Black	H	-20 °C / +100 °C



Abb. 3  
Fig. 3

Anschlussgewinde/-länge Connection thread/length		Art.-Nr. Art. no.	Ausführung bitte ergänzen Please indicate product details		Dichtbereich Sealing range	Bauhöhe Mounting height	Schlüsselweite Spanner width	
A	D mm	Grau/Grey Schwarz/Black	= PC = PCn	p = TPE-V H = Silikon HT/Silicone HT	max./min. ø mm	C mm	SW x E mm	
Pg 7	8,0	149		7	6,5 – 4,0	23,0	15x16,5	50
Pg 9	9,0	150		7	6,5 – 4,0	23,0	19x21,2	50
		150		8	8,0 – 5,0	23,0	19x21,2	50
		150		9	9,5 – 6,5	23,0	19x21,2	50
Pg 11	9,0	151		7	6,5 – 4,0	24,0	22x24,4	50
		151		8 *	8,0 – 5,0	24,0	22x24,4	50
		151		9	9,5 – 6,5	24,0	22x24,4	50
		151		11	10,5 – 7,0	24,0	22x24,4	50
Pg 13,5	9,0	152		7	6,5 – 4,0	24,0	24x26,5	50
		152		8	8,0 – 5,0	24,0	24x26,5	50
		152		9	9,5 – 6,5	24,0	24x26,5	50
		152		11	10,5 – 7,0	24,0	24x26,5	50
		152		13	13,0 – 9,0	24,0	24x26,5	50
Pg 16	9,0	153		7	6,5 – 4,0	24,0	27x29,5	50
		153		8	8,0 – 5,0	24,0	27x29,5	50
		153		9	9,5 – 6,5	24,0	27x29,5	50
		153		11	10,5 – 7,0	24,0	27x29,5	50
		153		13	13,0 – 9,0	24,0	27x29,5	50
		153		16	15,5 – 11,5	24,0	27x29,5	50
Pg 21	11,0	154		11	10,5 – 7,0	29,0	33x36,5	25
		154		13	13,0 – 9,0	29,0	33x36,5	25
		154		16	15,5 – 11,5	29,0	33x36,5	25
		154		18	18,0 – 14,0	29,0	33x36,5	25
		154		20	20,5 – 17,0	29,0	33x36,5	25
Pg 29	11,0	155		13 *	13,0 – 9,0	33,0	43x46,5	10
		155		16	15,5 – 11,5	33,0	43x46,5	10
		155		18	18,0 – 14,0	33,0	43x46,5	10
		155		20	20,5 – 17,0	33,0	43x46,5	10
		155		25	25,0 – 20,0	33,0	43x46,5	10
		155		28	28,0 – 24,0	33,0	43x46,5	10
Pg 36	14,0	156		32	32,0 – 27,0	33,0	53x57	5
		156		34	34,0 – 29,0	33,0	53x57	5
		156		36	36,0 – 32,0	33,0	53x57	5

\* Dichteinsatz aus Silikon HT nicht lieferbar.  
\* Silicone HT sealing insert not available.

**i** **Schutzart IP 68 ausschließlich in Verbindung mit separat auf Anfrage erhältlichlicher Flachdichtung.**  
Type of protection IP 68 only in combination with flat gasket, which is separately available on request.

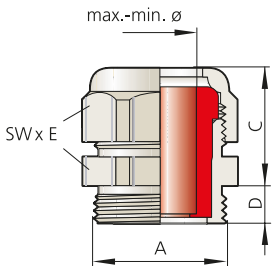
Technische Details und Informationen zu Zulassungen ab Seite 419  
For technical details and information on certifications, see page 419 ff.

**UNI Dicht Pg-Kabelverschraubung**

UNI Dicht Pg cable gland



Abb. 1  
Fig. 1



Abb. 2  
Fig. 2

**PVDF, Farben: Transparent, Blau (RAL 5015), Schwarz (RAL 9005)  
Pg-Anschlussgewinde  
Schutzart IP 68 bis 10 bar  
Zugentlastung bis Klasse A, EN 62444**

*PVDF, colour: transparent, blue (RAL 5015), black (RAL 9005)  
Pg connection thread  
Type of protection IP 68 up to 10 bar  
Strain relief up to class A, EN 62444*

**i Anschlussgewinde mit 15 mm Länge auf Anfrage**  
*Long connection thread 15 mm on request*

Werkstoff Verschraubungskörper <i>Material gland body</i>	Ausführung/Farbe <i>Version/colour</i>	Bestellschlüssel <i>Art. no. supplement</i>	Werkstoff Dichteinsatz <i>Material sealing insert</i>	Farbe <i>Colour</i>	Bestellschlüssel <i>Art. no. supplement</i>	Temperaturbereich min./max. <i>Temperature range (min./max.)</i>
PVDF	Transparent		TPE	s. FC See CC		-40 °C / +130 °C
PVDF	Transparent		TPE-V	Natur <i>Natural</i>	p	-40 °C / +135 °C
PVDF	Transparent		Silikon HT <i>Silicone HT</i>	Schwarz <i>Black</i>	H	-40 °C / +150 °C
PVDF	Blau <i>Blue</i>	a	TPE	s. FC See CC		-40 °C / +130 °C
PVDF	Blau <i>Blue</i>	a	TPE-V	Natur <i>Natural</i>	p	-40 °C / +135 °C
PVDF	Blau <i>Blue</i>	a	Silikon HT <i>Silicone HT</i>	Schwarz <i>Black</i>	H	-40 °C / +150 °C
PVDF	Schwarz <i>Black</i>	n	TPE	s. FC See CC		-40 °C / +130 °C
PVDF	Schwarz <i>Black</i>	n	TPE-V	Natur <i>Natural</i>	p	-40 °C / +135 °C
PVDF	Schwarz <i>Black</i>	n	Silikon HT <i>Silicone HT</i>	Schwarz <i>Black</i>	H	-40 °C / +150 °C



Abb. 3  
Fig. 3

Anschlussgewinde/-länge <i>Connection thread/length</i>		Art.-Nr. <i>Art. no.</i>	Dichtbereich <i>Sealing range</i>	Bauhöhe <i>Mounting height</i>	Schlüsselweite <i>Spanner width</i>	
Ausführung bitte ergänzen <i>Please indicate product details</i>						
A	D mm	Transparent = a	= TPE	max./min. ø mm	C mm	SW x E mm
		Blau/Blue = p	= TPE-V			
		Schwarz/Black = n	= Silikon HT/Silicone HT			
Pg 7	8,0	149y	7	6,5 – 4,0	23,0	15x16,5 50
Pg 9	8,0	150y	7	6,5 – 4,0	24,0	19x21,2 50
		150y	8	8,0 – 5,0	24,0	19x21,2 50
		150y	9	9,5 – 6,5	24,0	19x21,2 50
Pg 11	8,0	151y	7	6,5 – 4,0	24,0	22x24,4 50
		151y	8 *	8,0 – 5,0	24,0	22x24,4 50
		151y	9	9,5 – 6,5	24,0	22x24,4 50
		151y	11	10,5 – 7,0	24,0	22x24,4 50
Pg 13,5	9,0	152y	7	6,5 – 4,0	26,0	24x26,5 50
		152y	8	8,0 – 5,0	26,0	24x26,5 50
		152y	9	9,5 – 6,5	26,0	24x26,5 50
		152y	11	10,5 – 7,0	26,0	24x26,5 50
		152y	13	13,0 – 9,0	26,0	24x26,5 50
Pg 16	9,0	153y	7	6,5 – 4,0	26,0	27x29,5 50
		153y	8	8,0 – 5,0	26,0	27x29,5 50
		153y	9	9,5 – 6,5	26,0	27x29,5 50
		153y	11	10,5 – 7,0	26,0	27x29,5 50
		153y	13	13,0 – 9,0	26,0	27x29,5 50
		153y	16	15,5 – 11,5	26,0	27x29,5 50
Pg 21	11,0	154y	11	10,5 – 7,0	29,0	33x36,5 25
		154y	13	13,0 – 9,0	29,0	33x36,5 25
		154y	16	15,5 – 11,5	29,0	33x36,5 25
		154y	18	18,0 – 14,0	29,0	33x36,5 25
		154y	20	20,5 – 17,0	29,0	33x36,5 25
Pg 29	10,5	155y	13 *	13,0 – 9,0	33,0	43x46,5 10

\* Dichteinsatz aus Silikon HT nicht lieferbar.  
\* *Silicone HT sealing insert not available.*

Technische Details und Informationen zu Zulassungen ab Seite 419  
*For technical details and information on certifications, see page 419 ff.*

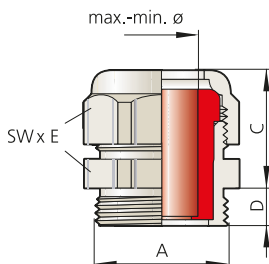
Fortsetzung auf der nächsten Seite  
*Continued on next page*

## UNI Dicht Pg-Kabelverschraubung

UNI Dicht Pg cable gland

Fortsetzung von vorheriger Seite  
Continued from previous page

Anschlussgewinde/-länge Connection thread/length		Art.-Nr. Art. no.		Dichtbereich Sealing range	Bauhöhe Mounting height	Schlüsselweite Spanner width	
A	D mm	Ausführung bitte ergänzen Please indicate product details		max./min. ø mm	C mm	SW x E mm	
		Transparent = a Blau/Blue = a p Schwarz/Black = n	= H = TPE = TPE-V = Silikon HT/Silicone HT				
Pg 29	10,5	155y	16	15,5 – 11,5	33,0	43x46,5	10
		155y	18	18,0 – 14,0	33,0	43x46,5	10
		155y	20	20,5 – 17,0	33,0	43x46,5	10
		155y	25	25,0 – 20,0	33,0	43x46,5	10
		155y	28	28,0 – 24,0	33,0	43x46,5	10
Pg 36	13,0	156y	32	32,0 – 27,0	34,0	53x57	5
		156y	34	34,0 – 29,0	34,0	53x57	5
		156y	36	36,0 – 32,0	34,0	53x57	5
Pg 42	13,0	157y	36 * **	36,0 – 32,0	38,0	60x65	5
		157y	40 * **	40,0 – 36,0	38,0	60x65	5
Pg 48	14,0	158y	44 * **	44,0 – 39,0	41,0	65x70	5

\* Dichteinsatz aus Silikon HT nicht lieferbar. \*\* Werkstoff POM (Farbe Weiß), Temperaturbereich: -40 °C bis +110 °C.  
\* Silicone HT sealing insert not available. \*\* Material POM (white), temperature range: -40 °C up to +110 °C.

**i** Schutzart IP 68 ausschließlich in Verbindung mit separat auf Anfrage erhältlichlicher Flachdichtung.  
Type of protection IP 68 only in combination with flat gasket, which is separately available on request.

14000 | TT00510

**UNI Dicht Erweitert – Pg**

*UNI Dicht Extended – Pg*



1

Abb. 1 – UNI Dicht Erweitert – Messing  
Fig. 1 – UNI Dicht Extended – Brass



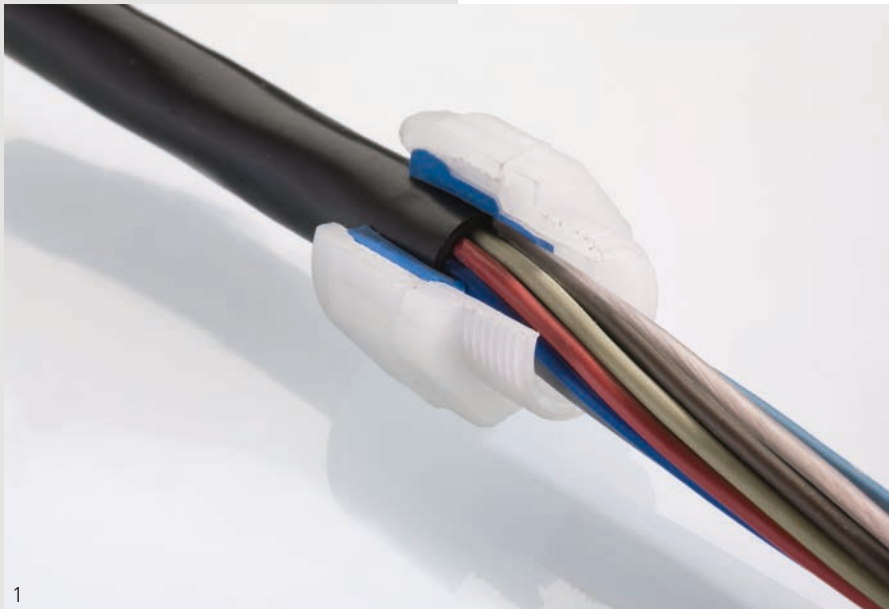

1

**Dicke Kabel durch kleine Bohrung**

Sollen Kabel mit dickerem Durchmesser durch eine bestehende Bohrung geführt werden, lässt sich das mit sogenannten „erweiterten“ Doppelnippeln einfach realisieren. Diese verfügen über ein vergrößertes Kopfteil für die Aufnahme eines entsprechend kurzen Dichtensatzes. Das abgemantelte Kabel mit seinem deutlich kleineren Adernquerschnitt wird sicher durch den Anschlussbereich der Kabelverschraubung geführt.

**Thick cables through small holes**

*If a thicker cable has to be fed through an existing hole, this can be done simply with an "extended" double nipple. This has an enlarged head to accept a correspondingly short sealing insert. The stripped cable with its significantly smaller diameter fits easily through the connection area of the cable gland.*



2

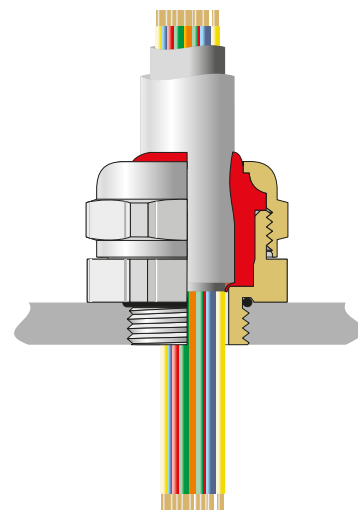

3



Abb. 1 – UNI Dicht Erweitert – PVDF  
Fig. 1 – UNI Dicht Extended – PVDF

Abb. 2 – UNI Dicht Erweitert – PVDF  
Fig. 2 – UNI Dicht Extended – PVDF

Abb. 3 – Querschnitt UNI Dicht Erweitert  
Fig. 3 – Cross section of the UNI Dicht Extended

**UNI Dicht Erweitert – Pg**

UNI Dicht Extended – Pg



Abb. 1  
Fig. 1



Abb. 2  
Fig. 2

**Messing vernickelt**  
**Pg-Anschlussgewinde**  
**Mit O-Ring aus HNBR**  
**Schutzart IP 68 bis 10 bar**  
**Zugentlastung bis Klasse A, EN 62444**

Brass, nickel-plated  
Pg connection thread  
With o-ring made of HNBR  
Type of protection IP 68 up to 10 bar  
Strain relief up to class A, EN 62444

**i** **Achtung: für Dichteinsätze mit kurzer Bauform Art.-Nr. Ek... verwenden**  
Note: For short sealing inserts, use Art. no. Ek...

Werkstoff Verschraubungskörper Material gland body	Ausführung/Farbe Version/colour	Werkstoff Dichteinsatz Material sealing insert	Farbe Colour	Bestellschlüssel Art. no. supplement	Temperaturbereich min./max. Temperature range (min./max.)
Messing Brass	Vernickelt Nickel-plated	TPE	s. FC See CC	d	-40 °C / +130 °C
Messing Brass	Vernickelt Nickel-plated	TPE-V	Natur Natural	p	-40 °C / +135 °C
Messing Brass	Vernickelt Nickel-plated	Silikon HT Silicone HT	Schwarz Black	H	-55 °C / +200 °C



Abb. 3  
Fig. 3

Anschlussgewinde/-länge Connection thread/ length	Art.-Nr. Art. no.	Dichtbereich Sealing range	Innendurchmesser Inside diameter	Durchlass Druckschraube max. Opening pressure screw max.	Bauhöhe Mounting height	Schlüsselweite Spanner width
Ausführung bitte ergänzen Please indicate product details						
A	D	max./min. ø	E	F	C	SW x E
	mm	mm	mm	mm	mm	mm
Pg 7	5,0	8	9,0	10,0	20,0	17x18,9 50
		14950	9	10,0	20,0	17x18,9 50
		14951	11	11,5	21,0	20x22,2 50
Pg 7	5,5	11	9,0	11,5	21,0	20x22,2 50
Pg 9	6,0	11	12,0	11,5	21,0	20x22,2 50
		15052	13	13,5	21,0	22x24,4 50
Pg 11	6,0	13	13,5	13,5	21,0	22x24,4 50
		15153	16	16,0	21,0	24x26,7 50
Pg 13,5	6,5	16	17,0	16,0	21,0	24x26,7 50
		15254	18	18,5	25,0	30x33,5 25
		15254	20	21,0	25,0	30x33,5 25
Pg 16	6,5	18	18,5	18,5	24,0	30x33,5 25
		15354	20	21,0	24,0	30x33,5 25
		15355	25	29,0	27,0	40x43,5 25
		15355	28	29,0	27,0	40x43,5 25
Pg 21	7,0	25	24,0	29,0	27,0	40x43,5 10
		15455	28	29,0	27,0	40x43,5 10
		15456	32	38,0	28,0	50x54 5
		15456	34	38,0	28,0	50x54 5
		15456	36	38,0	28,0	50x54 5
Pg 29	8,0	32	32,0	38,0	28,0	50x54 5
		15556	34	38,0	28,0	50x54 5
		15556	36	38,0	28,0	50x54 5
Pg 36	9,0	38 *	42,0	42,0	30,0	57x61,5 5
		15657	40 *	42,0	30,0	57x61,5 5
Pg 48	10,0	47 *	52,3	59,5	45,0	81x87 1
		158212	52 *	59,5	45,0	81x87 1
		158212	55 *	59,5	45,0	81x87 1
		158212	58 *	59,5	45,0	81x87 1
		158300	64 *	72,5	45,0	95x102 1
		158300	70 *	72,5	45,0	95x102 1

\* Dichteinsatz aus Silikon HT nicht lieferbar.  
\* Silicone HT sealing insert not available.

**i** **Passende Gegenmuttern ab Seite 384**  
For matching lock nuts, see from page 384

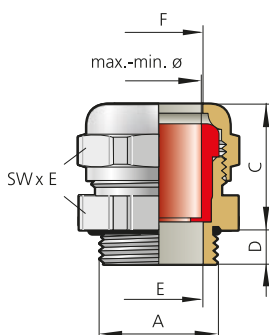
Technische Details und Informationen zu Zulassungen ab Seite 419  
For technical details and information on certifications, see page 419 ff.

**UNI Dicht Erweitert – Pg**

UNI Dicht Extended – Pg



Abb. 1  
Fig. 1

Abb. 2  
Fig. 2

**Polycarbonat, Farben: Grau (RAL 7035), Schwarz (RAL 9005)**  
**Pg-Anschlussgewinde**  
**Schutzart IP 68 bis 10 bar**  
**Zugentlastung bis Klasse A, EN 62444**

Polycarbonate, colour: grey (RAL 7035), black (RAL 9005)  
 Pg connection thread  
 Type of protection IP 68 up to 10 bar  
 Strain relief up to class A, EN 62444

**i** **Achtung: für Dichteinsätze mit kurzer Bauform Art.-Nr. Ek... verwenden**  
 Note: For short sealing inserts, use Art. no. Ek...

Werkstoff Verschraubungskörper Material gland body	Ausführung/Farbe Version/colour	Bestellschlüssel Art. no. supplement	Werkstoff Dichteinsatz Material sealing insert	Farbe Colour	Bestellschlüssel Art. no. supplement	Temperaturbereich min./max. Temperature range (min./max.)
PC	Grau Grey		TPE	s. FC See CC		-20 °C / +100 °C
PC	Grau Grey		TPE-V	Natur Natural	p	-20 °C / +100 °C
PC	Grau Grey		Silikon HT Silicone HT	Schwarz Black	H	-20 °C / +100 °C
PC	Schwarz Black	n	TPE	s. FC See CC		-20 °C / +100 °C
PC	Schwarz Black	n	TPE-V	Natur Natural	p	-20 °C / +100 °C
PC	Schwarz Black	n	Silikon HT Silicone HT	Schwarz Black	H	-20 °C / +100 °C



Abb. 3  
Fig. 3

Anschlussgewinde/-länge Connection thread/length	Art.-Nr. Art. no.	Dichtbereich Sealing range	Innen-durchmesser Inside diameter	Durchlass Druck-schraube max. Opening pressure screw max.	Bauhöhe Mounting height	Schlüssel-weite Spanner width
Ausführung bitte ergänzen Please indicate product details						
<b>A</b>	<b>D</b>	Grau/Grey = p Schwarz/Black = n	= TPE = TPE-V = Silikon HT/Silicone HT	<b>max./min. ø</b>	<b>E</b> <b>F</b>	<b>C</b> <b>SW x E</b>
Pg 7	8,0	14950PC	8	8,0 – 5,0	8,5   10,0	22,0   19x21,2   50
		14950PC	9	9,5 – 6,5	8,5   10,0	22,0   19x21,2   50
Pg 9	8,0	15051PC	11	10,5 – 7,0	11,5   11,0	23,0   22x24,5   50
Pg 11	8,0	15152PC	13	13,0 – 9,0	14,5   13,0	24,0   24x26,5   50
Pg 13,5	8,5	15253PC	16	15,5 – 11,5	16,4   16,0	24,0   27x29,5   50
Pg 13,5	9,0	15254PC	18	18,0 – 14,0	16,4   21,0	29,0   33x36,5   25
		15254PC	20	20,5 – 17,0	16,4   21,0	29,0   33x36,5   25
Pg 16	9,0	15354PC	18	18,0 – 14,0	17,2   21,0	30,0   33x36,5   25
		15354PC	20	20,5 – 17,0	17,2   21,0	30,0   33x36,5   25
Pg 21	11,0	15455PC	25	25,0 – 20,0	23,0   28,0	34,0   43x46,5   10
		15455PC	28	28,0 – 24,0	23,0   28,0	34,0   43x46,5   10
Pg 29	11,0	15556PC	32	32,0 – 27,0	31,5   37,0	35,0   53x57   5
		15556PC	34	34,0 – 29,0	31,5   37,0	35,0   53x57   5
		15556PC	36	36,0 – 32,0	31,5   37,0	35,0   53x57   5

**i** **Passende Gegenmuttern ab Seite 384**  
 For matching lock nuts, see from page 384

**i** **Schutzart IP 68 ausschließlich in Verbindung mit separat auf Anfrage erhältlichlicher Flachdichtung.**  
 Type of protection IP 68 only in combination with flat gasket, which is separately available on request.

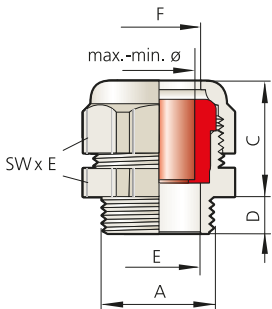

Abb. 1  
Fig. 1

Abb. 2  
Fig. 2

**PVDF, Farben: Transparent, Blau (RAL 5015), Schwarz (RAL 9005)  
Pg-Anschlussgewinde  
Schutzart IP 68 bis 10 bar  
Zugentlastung bis Klasse A, EN 62444**

*PVDF, colour: transparent, blue (RAL 5015), black (RAL 9005)  
Pg connection thread  
Type of protection IP 68 up to 10 bar  
Strain relief up to class A, EN 62444*

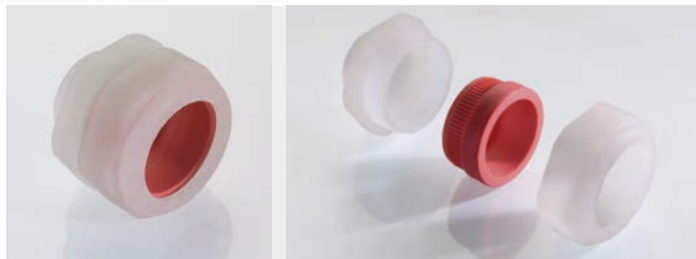
**i Achtung: für Dichteinsätze mit kurzer Bauform Art.-Nr. Ek... verwenden**  
*Note: For short sealing inserts, use Art. no. Ek...*

Werkstoff Verschraubungskörper <i>Material gland body</i>	Ausführung/Farbe <i>Version/colour</i>	Bestellschlüssel <i>Art. no. supplement</i>	Werkstoff Dichteinsatz <i>Material sealing insert</i>	Farbe <i>Colour</i>	Bestellschlüssel <i>Art. no. supplement</i>	Temperaturbereich min./max. <i>Temperature range (min./max.)</i>
PVDF	Transparent		TPE	s. FC See CC		-40 °C / +130 °C
PVDF	Transparent		TPE-V	Natur <i>Natural</i>	p	-40 °C / +135 °C
PVDF	Transparent		Silikon HT <i>Silicone HT</i>	Schwarz <i>Black</i>	H	-40 °C / +150 °C
PVDF	Blau <i>Blue</i>	a	TPE	s. FC See CC		-40 °C / +130 °C
PVDF	Blau <i>Blue</i>	a	TPE-V	Natur <i>Natural</i>	p	-40 °C / +135 °C
PVDF	Blau <i>Blue</i>	a	Silikon HT <i>Silicone HT</i>	Schwarz <i>Black</i>	H	-40 °C / +150 °C
PVDF	Schwarz <i>Black</i>	n	TPE	s. FC See CC		-40 °C / +130 °C
PVDF	Schwarz <i>Black</i>	n	TPE-V	Natur <i>Natural</i>	p	-40 °C / +135 °C
PVDF	Schwarz <i>Black</i>	n	Silikon HT <i>Silicone HT</i>	Schwarz <i>Black</i>	H	-40 °C / +150 °C



Abb. 3  
Fig. 3

Anschlussgewinde/-länge <i>Connection thread/length</i>	Art.-Nr. <i>Art. no.</i>	Dichtbereich <i>Sealing range</i>	Innen-durchmesser <i>Inside diameter</i>	Durchlass Druck-schraube max. <i>Opening pressure screw max.</i>	Bauhöhe <i>Mounting height</i>	Schlüssel-weite <i>Spanner width</i>
Ausführung bitte ergänzen <i>Please indicate product details</i>						
A	D	max./min. ø	E	F	C	SW x E
	mm	mm	mm	mm	mm	mm
Pg 7	8,0 14950y	8 9	8,0 – 5,0 8,5	10,0 10,0	23,0	19x21,2 50
Pg 9	8,0 15051y	11	10,5 – 7,0 8,5	11,0	23,0	22x24,5 50
Pg 9	8,5 15052y	13	13,0 – 9,0 11,5	13,0 13,0	26,0	26,5x26,5 50
Pg 11	8,0 15152y	13	13,0 – 9,0 14,2	13,0	26,0	24x26,5 50
Pg 11	9,0 15153y	16	15,5 – 11,5 14,2	16,0	27,0	27x29,5 50
Pg 13,5	8,5 15253y	16	15,5 – 11,5 16,4	16,0	27,0	27x29,5 50
Pg 13,5	9,0 15254y	18 20	18,0 – 14,0 16,4	21,0 21,0	30,0	33x36,5 25
Pg 16	9,0 15354y	18 20	18,0 – 14,0 17,2	21,0 21,0	30,0	33x36,5 25
Pg 16	10,0 15355y	25 28	25,0 – 20,0 22,0	28,0 28,0	32,0	43x46,5 10
Pg 21	10,0 15456y	32 34 36	32,0 – 27,0 28,0	37,0 37,0 37,0	35,0	53x57 5
Pg 21	11,0 15455y	25 28	25,0 – 20,0 23,0	28,0 28,0	33,0	43x46,5 10
Pg 29	11,0 15556y	32 34 36	32,0 – 27,0 31,5	37,0 37,0	35,0	53x57 5

**i Schutzart IP 68 ausschließlich in Verbindung mit separat auf Anfrage erhältlichlicher Flachdichtung.**  
*Type of protection IP 68 only in combination with flat gasket, which is separately available on request.*

Technische Details und Informationen zu Zulassungen ab Seite 419  
*For technical details and information on certifications, see page 419 ff.*

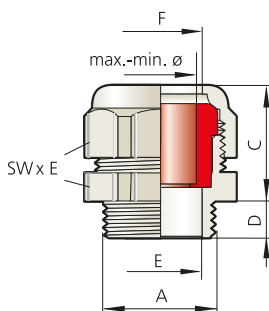

## UNI Mehrfach – Pg

*UNI Multiple – Pg*



Abb. 1 – UNI Mehrfach, montiert  
Fig. 1 – Assembled UNI Multiple

Abb. 2 – UNI Mehrfach und Verschlussbolzen für nicht belegte Löcher  
Fig. 2 – UNI Multiple and bolt for unused holes

Abb. 3 – UNI Mehrfach Dichteinsätze mit unterschiedlichen Lochbildern  
Fig. 3 – UNI Multiple sealing inserts with different hole patterns

### Mehrere Kabel sicher durch eine Bohrung führen

Wer aus Platz- oder Handlinggründen mehrere Kabel sicher durch eine Bohrung führen möchte, ersetzt den Standard-Dichteinsatz einfach durch Typen aus dem UNI Mehrfach Programm. Verschiedene Lochbilder stehen zur Verfügung, sodass sich auch unterschiedliche Kabeldurchmesser abdichten lassen. Dabei erreicht die UNI Mehrfach die Schutzart IP 65, wenn die Differenz von Kabeldurchmesser und Loch weniger als 10% beträgt. Sind beide gleich, lässt sich auch IP 68 (bis 10 bar) erreichen. Dichtigkeit und Zugentlastung sind abhängig vom verwendeten Kabel. Entsprechende Tests bietet PFLITSCH im eigenen Prüflabor an.

### Dichteinsätze nach Kundenwunsch

PFLITSCH fertigt diese Dichteinsätze exakt nach Kundenvorgabe aus dem hochwertigen Kunststoff TPE-V oder TPE. Dank dieser Fertigungsmethode kann PFLITSCH selbst Prototypen und Kleinserien zu wirtschaftlichen Preisen realisieren. Alternativ kann der Kunde geschlossene Dichteinsätze selbst mit Lochungen versehen. Nicht belegte Löcher werden mit einem Verschlussbolzen abgedichtet. Neben Lösungen mit runden Lochungen fertigt PFLITSCH auch Varianten für unterschiedliche Flachkabel und Kabel mit Sonderformen.

### Dichteinsätze für konfektionierte Kabel

Die Mehrfach-Dichteinsätze gibt es auch geteilt, z. B. für die Abdichtung von Kabeln, die bereits mit Steckern oder Sensoren konfektionierte sind. Diese Bauteile werden durch den Verschraubungskörper geführt, bevor die Kabel von den zwei Hälften des Dichteinsatzes zuverlässig umschlossen werden.

Für den gleichen Anwendungsfall bieten sich die seitlich geschlitzten Dichteinsätze an: Durch den nach außen offenen Schlitz lassen sich Kabel unkompliziert einführen.

### Feeding multiple cables safely through a single hole

Users wishing to feed multiple cables safely through a single hole for space reasons or for easier handling can replace the standard sealing insert with types from the UNI Multiple range. A number of hole patterns are available, so that a variety of cable diameters can be sealed. UNI Multiple fulfils type of protection IP 65 provided the difference between the cable and hole diameters is less than 10%. Should the values be the same, IP 68 (up to 10 bar) can be achieved. The tightness and strain relief depend on the cable used. PFLITSCH can conduct tests for this purpose in its own test laboratory.

### Customised sealing inserts

PFLITSCH manufactures these sealing inserts exactly to customer specifications from high-quality TPE-V or TPE plastic. This production method also enables PFLITSCH to make prototypes and small batches at affordable prices. Alternatively, customers can drill their own holes in closed sealing inserts. Unused holes are sealed with a bolt. In addition to solutions with round holes, PFLITSCH also offers variants for several different flat cables and cables with special shapes.

### Sealing inserts for pre-assembled cables

PFLITSCH can also supply split multiple sealing inserts, e.g. for sealing cables that are already pre-assembled with connectors or sensors. These components are fed through the gland body and the cables then reliably enclosed by the two halves of the sealing insert.

The laterally slit sealing inserts also lend themselves to this application: the slit is open to the outside, so that cables can simply be fed in.



PFLITSCH Mehrfach-Kabelverschraubungen



PFLITSCH multiple cable glands



Abb. 1 – Geteilter Mehrfach-Dichteinsatz  
Fig. 1 – Split multiple sealing insert

Abb. 2 – Kabelverschraubung für zwei ASI-Bus-Kabel  
Fig. 2 – Cable gland for two ASI bus cables

**UNI Mehrfach Pg-Kabelverschraubung**

UNI Multiple Pg cable gland



Abb. 1  
Fig. 1



Abb. 2  
Fig. 2

**Messing vernickelt, Edelstahl 1.4305, Polycarbonat, PVDF**  
**Pg-Anschlussgewinde**  
**Schutzart IP 65**  
**Schutzart IP 68 bis 10 bar, wenn Kabel- $\varnothing$  = Loch- $\varnothing$**   
**Zugentlastung bis Klasse A, EN 62444**

*Brass, nickel-plated, stainless steel AISI 303, polycarbonate, PVDF*  
*Pg connection thread*  
*Type of protection IP 65*  
*Type of protection IP 68 up to 10 bar, achievable if cable  $\varnothing$  = hole  $\varnothing$*   
*Strain relief up to class A, EN 62444*

Werkstoff Verschraubungskörper Material gland body	Ausführung/Farbe Version/colour	Bestellschlüssel Art. no. supplement	Werkstoff Dichteinsatz Material sealing insert	Farbe Colour	Bestellschlüssel Art. no. supplement	Temperaturbereich min./max. Temperature range (min./max.)
Messing Brass	Vernickelt Nickel-plated		TPE	Weiß White		-40 °C / +130 °C
Messing Brass	Vernickelt Nickel-plated		TPE-V	Natur Natural	p	-40 °C / +135 °C
VA 1.4305 AISI 303	Blank	st	TPE	Weiß White		-40 °C / +130 °C
VA 1.4305 AISI 303	Blank	st	TPE-V	Natur Natural	p	-40 °C / +135 °C
PC	Grau Grey	PC	TPE	Weiß White		-20 °C / +100 °C
PC	Grau Grey	PC	TPE-V	Natur Natural	p	-20 °C / +100 °C
PVDF	Transparent	y	TPE	Weiß White		-40 °C / +130 °C
PVDF	Transparent	y	TPE-V	Natur Natural	p	-40 °C / +135 °C



Abb. 3 – Beispiel „2 x 3“  
 2 = Anzahl Bohrungen  
 3 = Bohrungsdurchmesser in mm  
 Fig. 3 – Example “2 x 3”  
 2 = Number of holes  
 3 = Hole diameter in mm

Anschlussgewinde Connection thread	Art.-Nr. Art. no.	Ausführung bitte ergänzen Please indicate product details		
		Messing/Brass =		
		VA 1.4305/AISI 303 = st		
<b>A</b>		PC = PC	= TPE	
		PVDF = y	p = TPE-V	
Pg 7	149		m1x3	50
	149		m1x4	50
	149		m1x5	50
	149		m4x1,7 *	50
	14950		m1x5 *	50
	14950		m2x3 *	50
	14950		m2x4 *	50
	14950		m3x3 *	50
Pg 9	150		m1x1,5S/1x4	50
	150		m1x3	50
	150		m1x4	50
	150		m1x5	50
	150		m2x1,2 *	50
	150		m2x3	50
	150		m2x4	50
	150		m3x3	50
	150		m3x3,5	50
	150		m4x1,4 *	50
	150		m4x3	50
	150		m4x3,3	50
	15051		m1x2/2x4 * **	50
	15052		m1x4,7/1x6,4	50
	15052		m2x3 * **	50

\* Dichteinsatz kurz = Art.-Nr. Ek... \*\* Ausführung in Edelstahl nicht lieferbar.  
 \* Sealing insert short = Art. no. Ek... \*\* Version made of stainless steel not available.

Technische Details und Informationen zu Zulassungen ab Seite 419  
 For technical details and information on certifications, see page 419 ff.

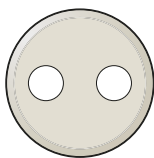
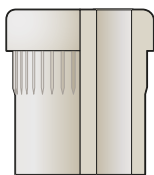
Fortsetzung auf der nächsten Seite  
 Continued on next page



## UNI Mehrfach Pg-Kabelverschraubung

UNI Multiple Pg cable gland

Fortsetzung von vorheriger Seite  
Continued from previous page

Anschlussgewinde Connection thread	Art.-Nr. Art. no.	Ausführung bitte ergänzen Please indicate product details		
		Messing/Brass =		
		VA 1.4305/AISI 303 = st		
<b>A</b>		PC = PC	= TPE	
		PVDF = y	p = TPE-V	
Pg 9	15052	m2x4	* **	50
	15052	m2x5	* **	50
	15052	m4x4	* **	50
	15052	m8x3	* **	50
Pg 11	151	m1x3		50
	151	m1x3/1x6		50
	151	m1x4		50
	151	m1x5		50
	151	m2x2,3		50
	151	m2x3		50
	151	m2x4		50
	151	m3x3		50
	151	m3x4		50
	151	m4x1,5	*	50
	151	m4x2,5/1x3,5		50
	151	m5x2,5		50
	151	m5x3		50
	151	m6x2		50
	151	m6x2,5		50
	151	m7x1,5	*	50
	151	m9x1,5	*	50
	15152	m2x6	* **	50
	15152	m3x4	* **	50
	15152	m3x5,3	* **	50
	15152	m4x4	* **	50
	15152	m8x3	* **	50
Pg 13,5	152	m1x2/3x3		50
	152	m1x2,5		50
	152	m1x3		50
	152	m1x3,5/1x6		50
	152	m1x3,5/2x4,5		50
	152	m1x4		50
	152	m1x4,7/1x6,4		50
	152	m1x5		50
	152	m1x8S		50
	152	m2x3		50
	152	m2x4/1x5,5		50
	152	m2x5		50
	152	m3x1,9/1x6	*	50
	152	m3x2	*	50
	152	m3x3		50
	152	m3x3/1x6		50
	152	m3x4		50
	152	m4x3		50
	152	m4x4		50

Anschlussgewinde Connection thread	Art.-Nr. Art. no.	Ausführung bitte ergänzen Please indicate product details		
		Messing/Brass =		
		VA 1.4305/AISI 303 = st		
<b>A</b>		PC = PC	= TPE	
		PVDF = y	p = TPE-V	
Pg 13,5	152	m6x2,5		50
	152	m6x3,5		50
	152	m7x3,3		50
	152	m8x1,5	*	50
	152	m8x2	*	50
	152	m10x2	*	50
	15253	m1x3/1x6/1x8	* **	50
	15253	m1x5/1x9	* **	50
	15253	m2x4	* **	50
	15253	m2x6	* **	50
	15253	m2x6/1x7	* **	50
	15253	m2x6,5	* **	50
	15253	m3x5/1x8	* **	50
	15253	m4x6	* **	50
	15253	m6x4	* **	50
Pg 16	153	m1x2,6		50
	153	m1x3		50
	153	m1x3/1x8		50
	153	m1x3/1x9		50
	153	m1x3,3/2x3,7		50
	153	m1x3,5		50
	153	m1x4		50
	153	m1x4/1x5		50
	153	m1x4/2x6/1x7		50
	153	m1x4/3x5		50
	153	m1x5		50
	153	m1x5/1x9		50
	153	m1x5/2x6		50
	153	m1x6/1x8		50
	153	m1x8S		50
	153	m2x3,2/2x6		50
	153	m2x3,3		50
	153	m2x3,5		50
	153	m2x3,5/1x5,5		50
	153	m2x3,5/1x8,5		50
	153	m2x4		50
	153	m2x5		50
	153	m2x5/1x6		50
	153	m2x6		50
	153	m2x6/1x7		50
	153	m2x6/1x8		50
	153	m3x1,9/1x2,4/1x7	*	50
	153	m3x2,5/1x3,5/1x7		50
	153	m3x3		50
	153	m3x3/1x6		50

21200 | IT01900

\* Dichteinsatz kurz = Art.-Nr. Ek... \*\* Ausführung in Edelstahl nicht lieferbar.  
\* Sealing insert short = Art. no. Ek... \*\* Version made of stainless steel not available.

Technische Details und Informationen zu Zulassungen ab Seite 419  
For technical details and information on certifications, see page 419 ff.

Fortsetzung auf der nächsten Seite  
Continued on next page

## UNI Mehrfach Pg-Kabelverschraubung

UNI Multiple Pg cable gland

Fortsetzung von vorheriger Seite  
Continued from previous page

Anschlussgewinde Connection thread	Art.-Nr. Art. no.	Ausführung bitte ergänzen Please indicate product details		
		Messing/Brass =		
		VA 1.4305/AISI 303 =	st	
<b>A</b>		PC =	PC = TPE	
		PVDF =	y p = TPE-V	
Pg 16	153		m3x3,5	50
	153		m3x4/1x9	50
	153		m3x5/1x8	50
	153		m3x6	50
	153		m4x3	50
	153		m4x4	50
	153		m4x5	50
	153		m4x6	50
	153		m6x4	50
	153		m7x2 *	50
	153		m9x3	50
	153		m13x2,7	50
	15354		m1x4/1x12 *	50
	15354		m1x4,5/1x12 *	50
	15354		m1x4,5/2x6,5 *	50
	15354		m1x5,5/1x9 *	50
	15354		m1x5,5/1x10,5 *	50
	15354		m1x5,8/1x6,9/1x8,4 *	50
	15354		m1x6/2x9 *	50
	15354		m1x6,5/1x12 *	50
	15354		m1x6,9/1x7,4/1x8,4 *	50
	15354		m1x7/1x8,5 *	50
	15354		m1x7/1x10,5 *	50
	15354		m1x7,5/1x8,5/1x10 *	50
	15354		m1x11,8 *	50
	15354		m2x5/1x5,5 *	50
	15354		m2x6 *	25
	15354		m2x6/2x8 *	50
	15354		m2x6,5/1x9,5 *	50
	15354		m2x7 *	50
	15354		m2x8 *	25
	15354		m2x9 *	50
	15354		m3x2,5/3x8 *	50
	15354		m3x7 *	50
	15354		m3x8 *	50
	15354		m3x9 *	50
	15354		m4x4,6/3x5,1 *	50
	15354		m4x5 *	50
	15354		m4x5/1x6,5 *	50
	15354		m4x6 *	50
	15354		m4x6,5 *	50
	15354		m4x7,5 *	50
	15354		m4x8 *	50
	15354		m5x5 *	25
	15354		m5x6 *	50

\* Dichteinsatz kurz = Art.-Nr. Ek...  
\* Sealing insert short = Art. no. Ek...

Anschlussgewinde Connection thread	Art.-Nr. Art. no.	Ausführung bitte ergänzen Please indicate product details		
		Messing/Brass =		
		VA 1.4305/AISI 303 =	st	
<b>A</b>		PC =	PC = TPE	
		PVDF =	y p = TPE-V	
Pg 16	15354		m6x5,5 *	50
	15354		m7x4 *	50
	15354		m8x4 *	50
	15354		m12x3,5 *	50
Pg 21	154		m1x2,9/2x6/1x6,1/1x6,8/1x7,3	25
	154		m1x3,2/2x5/1x6S	25
	154		m1x3,2/2x6/1x6,1/1x6,8/1x7,3	25
	154		m1x3,2/2x6/3x7	25
	154		m1x3,2S/2x5S/1x8,5S	25
	154		m1x4/1x5/1x13	25
	154		m1x4,3/1x6/1x8	25
	154		m1x4,5/2x7/1x8	25
	154		m1x4,5/2x8	25
	154		m1x5/1x9	25
	154		m1x5,4	25
	154		m1x5,7/1x13	25
	154		m1x5,7/2x6,3/1x8,5	25
	154		m1x6/2x9	25
	154		m1x6,5/1x12	25
	154		m1x7	25
	154		m1x7/1x8,5	25
	154		m1x7/1x10,5	25
	154		m2x4,5	25
	154		m2x4,5/1x13	25
	154		m2x6	25
	154		m2x6/2x8	25
	154		m2x7/3x7S	25
	154		m2x7,2/1x10,5	25
	154		m2x8	25
	154		m2x9	25
	154		m3x4	25
	154		m3x5	25
	154		m3x6/1x8	25
	154		m3x6/2x8	25
	154		m3x7	25
	154		m3x8	25
	154		m3x9	25
	154		m4x4	25
	154		m4x5	25
	154		m4x5/4x5S	25
	154		m4x6	25
	154		m4x6/1x8	25
	154		m4x6/3x6S	25
	154		m4x6,5	25
	154		m4x6,5/1x6,5SB	25

21.000 | IT01900

Technische Details und Informationen zu Zulassungen ab Seite 419  
For technical details and information on certifications, see page 419 ff.

Fortsetzung auf der nächsten Seite  
Continued on next page

## UNI Mehrfach Pg-Kabelverschraubung

UNI Multiple Pg cable gland

Fortsetzung von vorheriger Seite  
Continued from previous page

ANSchlussgewinde Connection thread	Art.-Nr. Art. no.	Ausführung bitte ergänzen Please indicate product details	
		Messing/Brass =	
		VA 1.4305/AISI 303 = st	
<b>A</b>		PC = PC	= TPE
		PVDF = y	p = TPE-V
Pg 21	154	m4x8	25
	154	m5x4	25
	154	m5x5	25
	154	m5x6	25
	154	m6x4	25
	154	m6x4/1x7	25
	154	m6x5	25
	154	m6x5,5	25
	154	m8x3	25
	154	m8x4	25
	154	m8x4/1x4SB	25
	154	m8x5	25
	154	m8x5,5	25
	154	m9x3	25
	154	m21x2	25
	15455	m1x3,5/2x8/1x14 *	10
	15455	m1x4/1x6/1x8/2x10 *	10
	15455	m1x4/1x9,3/1x10 *	10
	15455	m1x4/2x8 *	10
	15455	m1x5/3x8,5/1x10,5 *	10
	15455	m1x5,8/1x6,9/1x11 *	10
	15455	m1x5,8/2x11 *	10
	15455	m1x6,5/1x17 *	10
	15455	m1x6,5/2x11,2 *	10
	15455	m1x7/1x16 *	10
	15455	m1x7,2/1x9,1/1x9,3 *	10
	15455	m1x8/1x14 *	10
	15455	m1x8/1x9/1x12 *	10
	15455	m1x8/2x11 *	10
	15455	m1x8/2x8,5/1x15 *	10
	15455	m1x9/1x10 *	10
	15455	m1x9/1x10/1x11 *	10
	15455	m1x9/1x15 *	10
	15455	m1x10/1x12 *	10
	15455	m1x10/1x13 *	10
	15455	m1x10/1x15 *	10
	15455	m1x10,5/1x16 *	10
	15455	m1x10,7/1x13,8 *	10
	15455	m2x5/1x8,6/1x12,2 *	10
	15455	m2x5/2x9 *	10
	15455	m2x5,8/1x11 *	10
	15455	m2x6/2x10 *	10
	15455	m2x8,5/1x13,5 *	10
	15455	m2x10 *	10
	15455	m2x11 *	10

\* Dichteinsatz kurz = Art.-Nr. Ek...  
\* Sealing insert short = Art. no. Ek...

ANSchlussgewinde Connection thread	Art.-Nr. Art. no.	Ausführung bitte ergänzen Please indicate product details	
		Messing/Brass =	
		VA 1.4305/AISI 303 = st	
<b>A</b>		PC = PC	= TPE
		PVDF = y	p = TPE-V
Pg 21	15455	m2x12 *	10
	15455	m2x13 *	10
	15455	m3x9 *	10
	15455	m3x11 *	10
	15455	m4x5,5/1x8 *	10
	15455	m4x6,5 *	10
	15455	m4x8 *	10
	15455	m4x9 *	10
	15455	m4x10 *	10
	15455	m4x9S *	10
	15455	m5x8 *	10
	15455	m5x9 *	10
	15455	m5x9,5 *	10
	15455	m6x8 *	10
	15455	m8x5,5 *	10
	15455	m10x6 *	10
	15455	m11x5,2 *	10
	15455	m12x5,3 *	10
	15455	m24x3 *	10
Pg 29	155	m1x16S	10
	155	m1x4/1x6/1x8/2x10	10
	155	m1x4/2x6/4x8	10
	155	m1x4/2x7/2x9	10
	155	m1x4/7x7	10
	155	m1x4,5/4x8	10
	155	m1x5/2x9/1x13	10
	155	m1x5/4x9	10
	155	m1x5,5/1x9	10
	155	m1x5,8/2x11	10
	155	m1x6/1x10	10
	155	m1x6/1x8,5/1x10,5	10
	155	m1x6/2x6,5/2x8	10
	155	m1x6/2x9	10
	155	m1x6,5/1x17	10
	155	m1x6,5/2x7,5	10
	155	m1x6S/3x6/3x8/1x9,2	10
	155	m1x7/1x14	10
	155	m1x7/1x8,5/1x17	10
	155	m1x7/1x9,5/1x12	10
	155	m1x7/1x9/1x11	10
	155	m1x7/2x8,5	10
	155	m1x7/2x8/2x10	10
	155	m1x8/2x11	10
	155	m1x8/2x12	10
	155	m1x8/2x8,5/1x12	10

21200 | ITD | 990

Technische Details und Informationen zu Zulassungen ab Seite 419  
For technical details and information on certifications, see page 419 ff.

Fortsetzung auf der nächsten Seite  
Continued on next page

## UNI Mehrfach Pg-Kabelverschraubung

UNI Multiple Pg cable gland

Fortsetzung von vorheriger Seite  
Continued from previous page

Anschlussgewinde Connection thread	Art.-Nr. Art. no.	Ausführung bitte ergänzen Please indicate product details		
		Messing/Brass	=	
		VA 1.4305/AISI 303	= st	
<b>A</b>		PC	= PC = TPE	
		PVDF	= y p = TPE-V	
Pg 29	155	m1x8/2x8,5/1x15		10
	155	m1x8/12x4		10
	155	m1x8,5/1x12		10
	155	m1x8,5/1x14		10
	155	m1x9/1x10/1x11		10
	155	m1x9/1x15		10
	155	m1x9,5/1x11,5/1x13,5		10
	155	m1x10/1x11,5/1x13		10
	155	m1x10/1x12/1x13,5		10
	155	m1x10/1x13		10
	155	m1x10,5/1x16		10
	155	m1x10,7/1x13,8		10
	155	m1x12/1x13		10
	155	m2x4/2x5/2x7/2x8		10
	155	m2x4,8/2x6,3		10
	155	m2x5/1x8,6/1x12,2		10
	155	m2x5,8/1x11		10
	155	m2x6/1x10,5/1x12		10
	155	m2x6/1x7,5/2x8,5		10
	155	m2x6/1x8,5		10
	155	m2x6/2x6,5/1x7/1x7,5/1x10		10
	155	m2x6,5		10
	155	m2x6,5/1x10,5		10
	155	m2x7		10
	155	m2x7/1x9		10
	155	m2x8		10
	155	m2x8,5/1x13,5		10
	155	m2x8,5/2x11,5		10
	155	m2x9		10
	155	m2x9/1x13		10
	155	m2x9/1x15		10
	155	m2x10		10
	155	m2x11		10
	155	m2x12		10
	155	m2x13		10
	155	m3x3/7x4/1x8		10
	155	m3x3/8x5		10
	155	m3x3/8x5/1x8		10
	155	m3x7		10
	155	m3x7/3x8		10
	155	m3x9		10
	155	m3x9,5		10
	155	m3x11		10
	155	m3x12		10
	155	m4x3,5/2x7/1x11		10
	155	m4x5		10

Anschlussgewinde Connection thread	Art.-Nr. Art. no.	Ausführung bitte ergänzen Please indicate product details		
		Messing/Brass	=	
		VA 1.4305/AISI 303	= st	
<b>A</b>		PC	= PC = TPE	
		PVDF	= y p = TPE-V	
Pg 29	155	m4x5,5		10
	155	m4x5,5/1x8		10
	155	m4x5,7/2x10		10
	155	m4x6/3x8,5		10
	155	m4x6,5		10
	155	m4x6,5/4x6,5SB		10
	155	m4x8		10
	155	m4x9		10
	155	m4x10		10
	155	m5x3,5/2x5/1x6/2x6,5		10
	155	m5x8		10
	155	m5x9		10
	155	m6x4/3x6/1x8		10
	155	m6x6		10
	155	m6x7,4		10
	155	m6x8		10
	155	m7x4,8		10
	155	m7x6/1x11		10
	155	m7x7		10
	155	m8x5,5		10
	155	m10x6		10
	155	m12x4/1x8		10
	155	m12x5,3		10
	155	m13x3,5/1x9,5		10
	155	m16x3,5		10
	155	m17x3,5		10
	155	m20x3,5		10
	155	m24x3		10
	15556	m1x4/1x5/2x13 *		10
	15556	m1x4/2x6/4x9 *		10
	15556	m1x4/5x10 *		10
	15556	m1x11/1x21 *		10
	15556	m1x13/1x19 *		10
	15556	m1x14/1x17 *		10
	15556	m2x15 *		10
	15556	m3x7/4x10 *		5
	15556	m4x7 *		10
	15556	m4x13 *		10
	15556	m7x9 *		10
	15556	m8x8 *		5
	15556	m8x9 *		10
	15556	m12x6,4 *		10
Pg 36	156	m1x5/1x9/1x11/1x19		5
	156	m1x5/2x6,5/1x8,5/1x11		5
	156	m1x5/3x8/1x8,5/1x9,5		5
	156	m1x8/4x12,5		5

\* Dichteinsatz kurz = Art.-Nr. Ek...  
\* Sealing insert short = Art. no. Ek...

Technische Details und Informationen zu Zulassungen ab Seite 419  
For technical details and information on certifications, see page 419 ff.

Fortsetzung auf der nächsten Seite  
Continued on next page

## UNI Mehrfach Pg-Kabelverschraubung

UNI Multiple Pg cable gland

Fortsetzung von vorheriger Seite  
Continued from previous page

Anschlussgewinde Connection thread	Art.-Nr. Art. no.	Ausführung bitte ergänzen Please indicate product details	
		Messing/Brass =	
		VA 1.4305/AISI 303 =	st
<b>A</b>		PC =	PC = TPE
		PVDF =	y p = TPE-V
Pg 36	156	m1x9,5/2x13,5	5
	156	m1x10/3x11,5	5
	156	m1x11/1x21	5
	156	m1x11/2x13	5
	156	m1x12,5/1x16,5	5
	156	m1x13/2x16,5	5
	156	m1x14/1x17	5
	156	m1x55B/4x7/1x14	5
	156	m2x8/3x10	5
	156	m2x9	5
	156	m2x15	5
	156	m3x10	5
	156	m3x14,5	5
	156	m4x7	5
	156	m4x10,2	5
	156	m4x11,5	5
	156	m4x12	5
	156	m4x13	5
	156	m5x11,5	5
	156	m6x10	5
	156	m7x9	5
	156	m8x8	5
	156	m8x9	5
	156	m11x8	5
	156	m13x7	5
	156	m15x5	5
	156	m16x6	5
	15657	m1x12/1x25 **	5

Anschlussgewinde Connection thread	Art.-Nr. Art. no.	Ausführung bitte ergänzen Please indicate product details	
		Messing/Brass =	
		VA 1.4305/AISI 303 =	st
<b>A</b>		PC =	PC = TPE
		PVDF =	y p = TPE-V
Pg 36	15657	m2x17	* ** 5
Pg 42	157	m1x7,5/3x11/1x13 **	5
	157	m2x17 **	5
	157	m3x6,7/1x11/1x14,5 **	5
	157	m5x11 **	5
Pg 48	158	m1x5,5/1x9/2x15,5 **	5
	158	m1x5,5/4x15,5 **	5
	158	m1x9/1x11/3x15,5 **	5
	158	m1x11/1x32 **	5
	158	m1x13/3x17 **	5
	158	m1x30 **	5
	158	m1x35 **	5
	158	m2x4,5/2x21 **	5
	158	m2x11/2x17 **	5
	158	m2x15 **	5
	158	m2x16 **	5
	158	m3x12,5 **	5
	158	m3x13,5 **	5
	158	m3x14,5 **	5
	158	m3x18 **	5
	158	m4x12 **	5
	158	m4x16 **	5
	158	m6x5,1/1x10/1x10,5/2x13 **	5
	158	m8x10 **	5
	158	m8x12 **	5
	158	m13x3,5/9x5,2 **	5
	158	m18x7 **	5
	158	m23x3,3/4x5,1 **	5

212001 IT01980

\* Dichteinsatz kurz = Art.-Nr. Ek... \*\* Variante PC nicht lieferbar. Variante y aus Werkstoff POM (Farbe Weiß), Temperaturbereich: -40 °C bis +110 °C. Es besteht keine CSA-Zulassung.  
\* Sealing insert short = Art. no. Ek... \*\* Variant PC not available. Variant y made of POM (white), temperature range: -40 °C up to +110 °C, no CSA approval.

**i** VDE-Zulassung nur mit TPE-Dichteinsatz  
VDE approval only with TPE sealing insert

**i** Farbvarianten für PC: PCn = Schwarz  
PVDF: ya = Blau  
yn = Schwarz  
Colour variants for PC: PCn = black  
PVDF: ya = blue  
yn = black

**i** Varianten aus Polycarbonat (PC) und PVDF: Schutzart IP 68 (und Type 4X für PC) ausschließlich in Verbindung mit separat erhältlicher Flachdichtung auf Seite 407  
Polycarbonate (PC) and PVDF version: type of protection IP 68 (and Type 4X for PC) only in combination with separately available flat gasket on page 407

**UNI Dicht Pg mit geschlossenem Dichteinsatz**

UNI Dicht Pg with closed sealing insert



Abb. 1  
Fig. 1

Abb. 2  
Fig. 2

**Messing vernickelt, Edelstahl 1.4305, Polycarbonat, PVDF  
Pg-Anschlussgewinde  
Schutzart IP 68 bis 10 bar**

Brass, nickel-plated, stainless steel AISI 303, polycarbonate, PVDF  
Pg connection thread  
Type of protection IP 68 up to 10 bar

**i Anschlussgewinde mit 15 mm Länge auf Anfrage**  
Long connection thread 15 mm on request

Werkstoff Verschraubungskörper Material gland body	Ausführung/Farbe Version/colour	Bestellschlüssel Art. no. supplement	Werkstoff Dichteinsatz Material sealing insert	Farbe Colour	Temperaturbereich min./max. Temperature range (min./max.)
Messing Brass	Vernickelt Nickel-plated		TPE-V	Natur Natural	-40 °C / +135 °C
VA 1.4305 AISI 303	Blank	st	TPE-V	Natur Natural	-40 °C / +135 °C
PC	Grau Grey	PC	TPE-V	Natur Natural	-20 °C / +100 °C
PVDF	Transparent	y	TPE-V	Natur Natural	-40 °C / +135 °C



Abb. 3  
Fig. 3

Anschlussgewinde Connection thread	Art.-Nr. Art. no.		
		Ausführung bitte ergänzen Please indicate product details	
		Messing/Brass	=
		VA 1.4305/AISI 303	= st
		PC	= PC
		PVDF	= y
A			
Pg 7	149	pg	50
Pg 9	150	pg	50
Pg 11	151	pg	50
Pg 13,5	152	pg	50
Pg 16	153	pg	50
Pg 21	154	pg	25
	154	pg/21 *	25
Pg 29	155	pg	10
Pg 36	156	pg	5
Pg 42	157	pg **	5
Pg 48	158	pg **	5

\* Variante in y und PC nicht erhältlich. \*\* Variante y und PC aus Werkstoff POM (Farbe Weiß); Temperaturbereich: -40 °C bis +110 °C.

\* Variant y and PC not available. \*\* Variant y and PC made of POM (white), temperature range: -40 °C up to +110 °C.

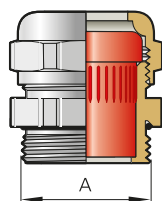
**i Die Anleitung zur Herstellung einer Kabelverschraubung mit eigenem Lochbild aus einem geschlossenem Dichteinsatz finden Sie im Technischen Anhang.**

The instructions for making a cable gland with your own hole pattern from a closed sealing insert can be found in the Technical Appendix.

**i Maximaler Kabeldurchlass der Druckschraube (F) und maximaler Kabeldurchlass des Doppelnippels (E) siehe Technischer Anhang**

For maximum cable passage of pressure screw (F) and maximum cable passage of double nipple (E), see Technical Appendix

**i Varianten aus Polycarbonat (PC) und PVDF: Schutzart IP 68 ausschließlich in Verbindung mit separat auf Anfrage erhältlichem Flachdichtung**

Polycarbonate (PC) and PVDF version: type of protection IP 68 only in combination with flat gasket, which is separately available on request

**i Farbvarianten für**  
Colour variants for

PC:	PCn = Schwarz
PVDF:	ya = Blau
	yn = Schwarz
PC:	PCn = black
PVDF:	ya = blue
	yn = black

**i Hinweise zu den Baumaßen finden Sie auf Seite 425.**  
For information on system dimensions, see page 425.

**UNI Stecker Pg-Kabelverschraubung mit geteiltem Dichteinsatz**

UNI connector Pg cable gland with split sealing insert



Abb. 1  
Fig. 1

Abb. 2  
Fig. 2

**Messing vernickelt, Edelstahl 1.4305, Polycarbonat, PVDF**  
**Pg-Anschlussgewinde**  
**Schutzart IP 68 bis 10 bar**

Brass, nickel-plated, stainless steel AISI 303, polycarbonate, PVDF  
Pg connection thread  
Type of protection IP 68 up to 10 bar

i	<b>Farbvarianten für</b>	<b>PC:</b>	<b>PCn = Schwarz</b>
	Colour variants for	<b>PVDF:</b>	<b>ya = Blau</b>
			<b>yn = Schwarz</b>
		PC:	PCn = black
		PVDF:	ya = blue
			yn = black

Werkstoff Verschraubungskörper Material gland body	Ausführung/Farbe Version/colour	Bestellschlüssel Art. no. supplement	Werkstoff Dichteinsatz Material sealing insert	Farbe Colour	Temperaturbereich min./max. Temperature range (min./max.)
Messing Brass	Vernickelt Nickel-plated		TPE-V	Natur Natural	-40 °C / +135 °C
VA 1.4305 AISI 303	Blank	st	TPE-V	Natur Natural	-40 °C / +135 °C
PC	Grau Grey	PC	TPE-V	Natur Natural	-20 °C / +100 °C
PVDF	Transparent	y	TPE-V	Natur Natural	-40 °C / +135 °C

Anschlussgewinde Connection thread	Art.-Nr. Art. no.		
		Ausführung bitte ergänzen Please indicate product details	
		Messing/Brass	=
		VA 1.4305/AISI 303	= st
<b>A</b>		PC	= PC
		PVDF	= y
Pg 29	155	pmK	10
	155	pmK 1/ 5	10
	155	pmK 1/ 6	10
	155	pmK 1/ 6-1/ 8,5	10
	155	pmK 1/ 7	10
	155	pmK 1/ 8	10
	155	pmK 1/10	10
	155	pmK 1/12	10
	155	pmK 1/13,5	10
	155	pmK 1/17	10
	155	pmK 1/21	10
	155	pmK 2/ 6	10
	155	pmK 2/ 8	10
	155	pmK 2/10	10
Pg 36	156	pmK	10
	156	pmK 1/ 4,5	5
	156	pmK 1/ 4,5-1/ 9-1/ 9,5	5
	156	pmK 1/ 5-1/10-1/10,5	5
	156	pmK 1/ 8	5
	156	pmK 1/ 8-1/10,5-1/12	5
	156	pmK 1/10	5
	156	pmK 1/11	5
	156	pmK 1/12	5
	156	pmK 1/21	5
	156	pmK 1/23	5
	156	pmK 2/ 5,5-1/11,5	5
	156	pmK 2/ 6	10
	156	pmK 2/11,5	5
	156	pmK 3/ 7,2	5
	156	pmK 3/ 7,5	10

Technische Details und Informationen zu Zulassungen ab Seite 419  
For technical details and information on certifications, see page 419 ff.

Fortsetzung auf der nächsten Seite  
Continued on next page

## UNI Stecker Pg-Kabelverschraubung mit geteiltem Dichteinsatz

UNI connector Pg cable gland with split sealing insert

Fortsetzung von vorheriger Seite  
Continued from previous page

Anschlussgewinde Connection thread	Art.-Nr. Art. no.	Ausführung bitte ergänzen Please indicate product details		
		Messing/Brass	=	
A	VA 1.4305/AISI 303	=	st	
	PC	=	PC	
	PVDF	=	y	
Pg 36	156	pmK 3/ 7,8		5
	156	pmK 3/10		5
Pg 42	157	pmK *		5
	157	pmK 1/9 *		5
	157	pmK 1/26 *		5
	157	pmK 1/27 *		5
	157	pmK 1/30 *		5
	157	pmK 1/32 *		5
	157	pmK 2/ 9 *		5

\* Variante y und PC aus Werkstoff POM (Farbe Weiß); Temperaturbereich: -40 °C bis +110 °C.  
\* Variant y and PC made of POM (white), temperature range: -40 °C up to +110 °C.

Anschlussgewinde Connection thread	Art.-Nr. Art. no.	Ausführung bitte ergänzen Please indicate product details		
		Messing/Brass	=	
A	VA 1.4305/AISI 303	=	st	
	PC	=	PC	
	PVDF	=	y	
Pg 48	158	pmK *		5
	158	pmK 1/ 6 *		5
	158	pmK 1/ 6-1/ 8 *		5
	158	pmK 1/ 8 *		5
	158	pmK 1/28 *		5
	158	pmK 1/29 *		5
	158	pmK 1/32 *		5
	158	pmK 2/ 8 *		5

**i** Varianten aus Polycarbonat (PC) und PVDF: Schutzart IP 68 ausschließlich in Verbindung mit separat auf Anfrage erhältlicher Flachdichtung  
Polycarbonate (PC) and PVDF version: type of protection IP 68 only in combination with flat gasket, which is separately available on request

21800 | TT01920



**UNI Zoll Dicht Kabelverschraubung**

UNI imperial Dicht cable gland



Abb. 1  
Fig. 1



Abb. 2  
Fig. 2

**Messing vernickelt**  
**Zylindrisches Whitworth-Zoll-Gewinde nach DIN EN ISO 228-1**  
**Mit O-Ring aus HNBR**  
**Schutzart IP 68 bis 10 bar**  
**Zugentlastung bis Klasse A, EN 62444**

*Brass, nickel-plated*  
*Whitworth imperial thread according to DIN EN ISO 228-1*  
*With o-ring made of HNBR*  
*Type of protection IP 68 up to 10 bar*  
*Strain relief up to class A, EN 62444*

Werkstoff Verschraubungskörper Material gland body	Ausführung/Farbe Version/colour	Werkstoff Dichteinsatz Material sealing insert	Farbe Colour	Bestellschlüssel Art. no. supplement	Temperaturbereich min./max. Temperature range (min./max.)
Messing Brass	Vernickelt Nickel-plated	TPE	s. FC See CC		-40 °C / +130 °C
Messing Brass	Vernickelt Nickel-plated	TPE-V	Natur Natural	p	-40 °C / +135 °C
Messing Brass	Vernickelt Nickel-plated	Silikon HT Silicone HT	Schwarz Black	H	-55 °C / +200 °C

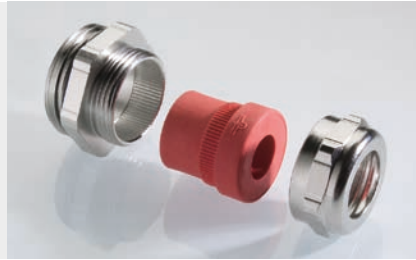

Abb. 3  
Fig. 3

Anschlussgewinde/-länge Connection thread/length	Art.-Nr. Art. no.	Dichtbereich Sealing range	Bauhöhe Mounting height	Schlüsselweite Spanner width
Ausführung bitte ergänzen Please indicate product details				
	TPE =			
	TPE-V = p			
	Silikon HT/Silicone HT = H			
<b>A</b>	<b>D</b>	<b>max./min. ø</b>	<b>C</b>	<b>SW<sub>1</sub> x E<sub>1</sub> / SW<sub>2</sub> x E<sub>2</sub></b>
	<b>mm</b>	<b>mm</b>	<b>mm</b>	<b>mm</b>
G1/4"	6,0	101449d 7	6,5 – 4,0	20,0 17x18,9/14x15,5 50
G3/8"	6,0	1038d 7 *	6,5 – 4,0	20,0 20x22,2 50
		1038d 9 *	9,5 – 6,5	20,0 20x22,2 50
G1/2"	7,0	101252d 7	6,5 – 4,0	21,0 22x24,4 50
		101252d 8	8,0 – 5,0	21,0 22x24,4 50
		101252d 9	9,5 – 6,5	21,0 22x24,4 50
		101252d 11	10,5 – 7,0	21,0 22x24,4 50
		101252d 13	13,0 – 9,0	21,0 22x24,4 50
G3/4"	9,0	103454d 11	10,5 – 7,0	27,0 30x33,5 25
		103454d 13	13,0 – 9,0	27,0 30x33,5 25
		103454d 16	15,5 – 11,5	27,0 30x33,5 25
		103454d 18	18,0 – 14,0	27,0 30x33,5 25
		103454d 20	20,5 – 17,0	27,0 30x33,5 25
G1"	9,0	110054d 11	10,5 – 7,0	25,0 35x38,3/30x33,5 25
		110054d 13	13,0 – 9,0	25,0 35x38,3/30x33,5 25
		110054d 16	15,5 – 11,5	25,0 35x38,3/30x33,5 25
		110054d 18	18,0 – 14,0	25,0 35x38,3/30x33,5 25
		110054d 20	20,5 – 17,0	25,0 35x38,3/30x33,5 25
G1 1/4"	9,0	1114d 30 *	30,0 – 26,0	28,0 45x48 10
G1 1/2"	9,0	111256d 32	32,0 – 27,0	28,0 50x54 5
		111256d 34	34,0 – 29,0	28,0 50x54 5
		111256d 36	36,0 – 32,0	28,0 50x54 5
G2"	10,0	120058d 44 *	44,0 – 39,0	31,0 64x69 5
G2 1/2"	15,0	1212d 47 *	47,0 – 42,0	40,0 81x87 1
		1212d 52 *	52,0 – 45,0	40,0 81x87 1
		1212d 55 *	55,0 – 51,0	40,0 81x87 1
		1212d 58 *	58,0 – 54,0	40,0 81x87 1
G3"	15,0	1300d 57 *	57,0 – 50,0	40,0 95x102 1
		1300d 64 *	64,0 – 58,0	40,0 95x102 1
		1300d 70 *	70,0 – 63,0	40,0 95x102 1

\* Dichteinsatz aus Silikon HT nicht lieferbar.  
\* Silicone HT sealing insert not available.

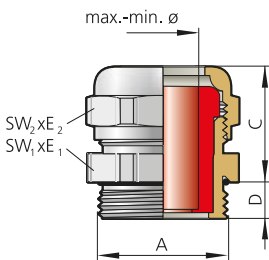

Abb. 1  
Fig. 1



Abb. 2  
Fig. 2

**Messing vernickelt**  
**Kegeliges NPT-Gewinde nach ANSI/ASME B1.20.1**  
**Schutzart IP 68 bis 10 bar**  
**Zugentlastung bis Klasse A, EN 62444**

Brass, nickel-plated  
 Conical NPT thread according to ANSI/ASME B1.20.1  
 Type of protection IP 68 up to 10 bar  
 Strain relief up to class A, EN 62444

Metallrohre mit kegelförmigem NPT-Anschlussgewinde werden in den USA und Japan zum Kabelschutz in der Elektroinstallation verwendet. Das kegelförmige Außengewinde ist selbstdichtend bei kegelförmigem Innengewinde (gasdicht) ohne zusätzliche Maßnahmen zur Abdichtung. Das NPT-Gewinde ist gemäß ANSI/ASME B1.20.1 genormt.

Metal pipes with conical NPT connection threads are used in the USA and Japan to protect cables in electrical installations. The conical external thread is self-sealing with the conical internal thread (gas-tight) without the use of additional measures to achieve the seal. The NPT thread is standardised in ANSI/ASME B1.20.1.

**Zur UNI NPT Dicht Kabelverschraubung passen alle Dichteinsätze des PFLITSCH Systems UNI Dicht für die Aufgaben:**

- Erhöhte Zugentlastung
- Mehrfach
- Flache Kabel
- Asi-Bus-Kabel
- Biegeschutz
- Geschlossene Einsätze und Druckschrauben mit:
  - Schlauchstutzen
  - Zugentlastung
  - Federbiegeschutz

**UNI NPT Dicht cable glands are suitable for all sealing inserts in the PFLITSCH UNI Dicht system which are used for the following tasks:**

- Increased strain relief
- Multiple
- Flat cables
- Asi bus cables
- Bending protection
- Closed inserts and pressure screws with:
  - Hose connectors
  - Strain relief
  - Spring-bending protection

Werkstoff Verschraubungskörper Material gland body	Ausführung/Farbe Version/colour	Werkstoff Dichteinsatz Material sealing insert	Farbe Colour	Bestellschlüssel Art. no. supplement	Temperaturbereich min./max. Temperature range (min./max.)
Messing Brass	Vernickelt Nickel-plated	TPE	s. FC See CC		-40 °C / +130 °C
Messing Brass	Vernickelt Nickel-plated	TPE-V	Natur Natural	p	-40 °C / +135 °C
Messing Brass	Vernickelt Nickel-plated	Silikon HT Silicone HT	Schwarz Black	H	-55 °C / +200 °C



Abb. 3  
Fig. 3

Anschlussgewinde/-länge Connection thread/length		Art.-Nr. Art. no.	Dichtbereich Sealing range	Bauhöhe Mounting height	Schlüsselweite Spanner width		
		Ausführung bitte ergänzen Please indicate product details					
		TPE =					
		TPE-V = p					
		Silikon HT/Silicone HT = H					
<b>A</b>	<b>D</b> mm		<b>max./min. ø</b> mm	<b>C</b> mm	<b>SW<sub>1</sub> x E<sub>1</sub>/SW<sub>2</sub> x E<sub>2</sub></b> mm		
NPT3/8"	13,0	303851d	7	6,5 – 4,0	28,0	20x22,2	50
		303851d	8 *	8,0 – 5,0	28,0	20x22,2	50
		303851d	9	9,5 – 6,5	28,0	20x22,2	50
		303851d	11	10,5 – 7,0	28,0	20x22,2	50
NPT1/2"	16,0	301253d	7	6,5 – 4,0	28,0	24x26,7/22x24,4	50
		301253d	8	8,0 – 5,0	28,0	24x26,7/22x24,4	50
		301253d	9	9,5 – 6,5	28,0	24x26,7/22x24,4	50
		301253d	11	10,5 – 7,0	28,0	24x26,7/22x24,4	50
		301253d	13	13,0 – 9,0	28,0	24x26,7/22x24,4	50
		301253d	16	15,5 – 11,5	28,0	24x26,7/22x24,4	50
NPT3/4"	16,0	303454d	11	10,5 – 7,0	35,0	30x33,5	25
		303454d	13	13,0 – 9,0	35,0	30x33,5	25
		303454d	16	15,5 – 11,5	35,0	30x33,5	25
		303454d	18	18,0 – 14,0	35,0	30x33,5	25
		303454d	20	20,5 – 17,0	35,0	30x33,5	25
NPT1"	20,0	310055d	16	15,5 – 11,5	39,0	40x43,5	10
		310055d	18	18,0 – 14,0	39,0	40x43,5	10
		310055d	20	20,5 – 17,0	39,0	40x43,5	10
		310055d	25	25,0 – 20,0	39,0	40x43,5	10
		310055d	28	28,0 – 24,0	39,0	40x43,5	10
NPT1 1/4"	20,0	311456d	32	32,0 – 27,0	40,0	50x54	10
		311456d	34	34,0 – 29,0	40,0	50x54	10
		311456d	36	36,0 – 32,0	40,0	50x54	10
NPT1 1/2"	22,0	311257d	36 *	36,0 – 32,0	40,0	57x61,5	5
		311257d	40 *	40,0 – 36,0	40,0	57x61,5	5
NPT2"	25,0	320058d	44 *	44,0 – 39,0	40,0	64x69	1

\* Dichteinsatz aus Silikon HT nicht lieferbar.  
 \* Silicone HT sealing insert not available.

Technische Details und Informationen zu Zulassungen ab Seite 419  
 For technical details and information on certifications, see page 419 ff.

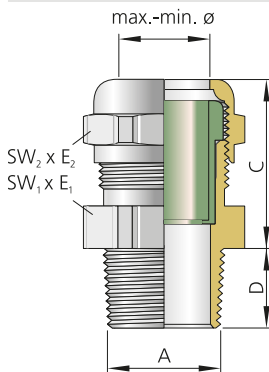

## Übersichtstabelle für die UNI Dicht Komponenten – Pg

Overview of UNI Dicht components – Pg

**Messing vernickelt, Edelstahl 1.4305, Polycarbonat: Farbe Grau (RAL 7035), PVDF: Farbe Transparent, mit Pg-Gewinde, Schutzart IP 68 bis 10 bar**

Nickel-plated brass, stainless steel AISI 303, polycarbonate: colour grey (RAL 7035), PVDF: colour transparent, with Pg connection thread, type of protection: IP 68 up to 10 bar

Anschlussgewinde Connection thread	Messing vernickelt Brass, nickel-plated			Edelstahl 1.4305 Stainless steel AISI 303			Polycarbonat Polycarbonate
	Druckschraube (DS) Pressure screw (DS)	Doppelnippel (DN) Double nipple (DN)	Verschraubungs- körper (VK) Gland body (VK)	Druckschraube (DS) Pressure screw (DS)	Doppelnippel (DN) Double nipple (DN)	Verschraubungs- körper (VK) Gland body (VK)	Druckschraube (DS) Pressure screw (DS)
Pg 7	DS 149d	DN 149d	VK 149d	DS 149st	DN 149st	VK 149st	DS 149PC
Pg 7	DS 150d	DN 14950d	VK 14950d				DS 150PC
Pg 7	DS 151d	DN 14951d	VK 14951d				
Pg 9	DS 150d	DN 150d	VK 150d	DS 150st	DN 150st	VK 150st	DS 150PC
Pg 9	DS 151d	DN 15051d	VK 15051d				DS 151PC
Pg 9	DS 152d	DN 15052d	VK 15052d				
Pg 9	DS 153d	DN 15053d	VK 15053d				
Pg 11	DS 151d	DN 151d	VK 151d	DS 151st	DN 151st	VK 151st	DS 151PC
Pg 11	DS 152d	DN 15152d	VK 15152d				DS 152PC
Pg 11	DS 153d	DN 15153d	VK 15153d				
Pg 11							
Pg 13,5	DS 152d	DN 152d	VK 152d	DS 152st	DN 152st	VK 152st	DS 152PC
Pg 13,5	DS 153d	DN 15253d	VK 15253d				DS 153PC
Pg 13,5	DS 154d18	DN 15254d	VK 15254d18				DS 154PC
Pg 13,5	DS 154d21	DN 15254d	VK 15254d21				
Pg 16	DS 153d	DN 153d	VK 153d	DS 153st	DN 153st	VK 153st	DS 153PC
Pg 16	DS 154d18	DN 15354d	VK 15354d18				DS 154PC
Pg 16	DS 154d21	DN 15354d	VK 15354d21				
Pg 16							

\* Werkstoff POM (Farbe Weiß), Temperaturbereich: -40 °C bis +110 °C.

\* Material POM (white), temperature range: -40 °C up to +110 °C.

Polycarbonat Polycarbonate		PVDF PVDF			Dichteinsätze Sealing inserts			
Doppelnippel (DN) Double nipple (DN)	Verschraubungs- körper (VK) Gland body (VK)	Druckschraube (DS) Pressure screw (DS)	Doppelnippel (DN) Double nipple (DN)	Verschraubungs- körper (VK) Gland body (VK)	TPE	TPE-V	Silikon Silicone	TPE – geschlossen TPE – closed
DN 149PC	VK 149PC	DS 149y	DN 149y	VK 149y	E 149/ 7	E 149p 7	E 149i 7 HF/HT	E 149g
DN 14950PC	VK 14950PC	DS 150y	DN 14950y	VK 14950y	Ek150/ 8	Ek150p 8	E 150i 8 HF/HT	Ek150g
					Ek150/ 9	Ek150p 9	E 150i 9 HF/HT	
					Ek151/ 8	Ek151p 8		Ek151g
					Ek151/ 9	Ek151p 9	E 151i 9 HF/HT	
					Ek151/11	Ek151p11	E 151i11 HF/HT	
DN 150PC	VK 150PC	DS 150y	DN 150y	VK 150y	E 150/ 7	E 150p 7	E 150i 7/HT	E 150g
					E 150/ 8	E 150p 8	E 150i 8/HT	
					E 150/ 9	E 150p 9	E 150i 9/HT	
DN 15051PC	VK 15051PC	DS 151y	DN 15051y	VK 15051y	Ek151/11	Ek151p11	E 151i11 HF/HT	Ek151g
		DS 152y	DN 15052y	VK 15052y	Ek152/11	Ek152p11	E 152i11 HF/HT	Ek152g
					Ek152/13	Ek152p13	E 152i13 HF/HT	
					Ek153/11	Ek153p11	E 153i11 HF/HT	Ek153g
					Ek153/13	Ek153p13	E 153i13 HF/HT	
					Ek153/16	Ek153p16	E 153i16 HF/HT	
DN 151PC	VK 151PC	DS 151y	DN 151y	VK 151y	E 151/ 7	E 151p 7	E 151i 7/HT	E 151g
					E 151/ 8	E 151p 8		
					E 151/ 9	E 151p 9	E 151i 9/HT	
					E 151/11	E 151p11	E 151i11/HT	
DN 15152PC	VK 15152PC	DS 152y	DN 15152y	VK 15152y	Ek152/13	Ek152p13	E 152i13 HF/HT	Ek152g
		DS 153y	DN 15153y	VK 15153y	Ek153/13	Ek153p13	E 153i13 HF/HT	Ek153g
					Ek153/16	Ek153p16	E 153i16 HF/HT	
		DS 154y	DN 15154p *	VK 15154p *	Ek154/13	Ek154p13	E 154i13 HF/HT	Ek154g
					Ek154/16	Ek154p16	E 154i16 HF/HT	
					Ek154/18	Ek154p18	E 154i18 HF/HT	
					Ek154/20	Ek154p20	E 154i20 HF/HT	
DN 152PC	VK 152PC	DS 152y	DN 152y	VK 152y	E 152/ 7	E 152p 7	E 152i 7/HT	E 152g
					E 152/ 8	E 152p 8	E 152i 8/HT	
					E 152/ 9	E 152p 9	E 152i 9/HT	
					E 152/11	E 152p11	E 152i11/HT	
					E 152/13	E 152p13	E 152i13/HT	
DN 15253PC	VK 15253PC	DS 153y	DN 15253y	VK 15253y	Ek153/16	Ek153p16	E 153i16 HF/HT	Ek153g
DN 15254PC	VK 15254PC	DS 154y	DN 15254y	VK 15254y	Ek154/16	Ek154p16	E 154i16 HF/HT	Ek154g
					Ek154/18	Ek154p18	E 154i18 HF/HT	
					Ek154/20	Ek154p20	E 154i20 HF/HT	Ek154g
DN 153PC	VK 153PC	DS 153y	DN 153y	VK 153y	E 153/ 7	E 153p 7	E 153i 7/HT	E 153g
					E 153/ 8	E 153p 8	E 153i 8/HT	
					E 153/ 9	E 153p 9	E 153i 9/HT	
					E 153/11	E 153p11	E 153i11/HT	
					E 153/13	E 153p13	E 153i13/HT	
					E 153/16	E 153p16	E 153i16/HT	
DN 15354PC	VK 15354PC	DS 154y	DN 15354y	VK 15354y	Ek154/16	Ek154p16	E 154i16 HF/HT	Ek154g
					Ek154/18	Ek154p18	E 154i18 HF/HT	
					Ek154/20	Ek154p20	E 154i20 HF/HT	Ek154g
		DS 155y	DN 15355y	VK 15355y	Ek155/18	Ek155p18	E 155i18 HF/HT	Ek155g
					Ek155/20	Ek155p20	E 155i20 HF/HT	
					Ek155/25	Ek155p25	E 155i25 HF/HT	
					Ek155/28	Ek155p28	E 155i28 HF/HT	

Fortsetzung auf der nächsten Seite ►  
Continued on next page

## Übersichtstabelle für die UNI Dicht Komponenten – Pg

Overview of UNI Dicht components – Pg

**Messing vernickelt, Edelstahl 1.4305, Polycarbonat: Farbe Grau (RAL 7035), PVDF: Farbe Transparent, mit Pg-Gewinde, Schutzart IP 68 bis 10 bar**

Nickel-plated brass, stainless steel AISI 303, polycarbonate: colour grey (RAL 7035), PVDF: colour transparent, with Pg connection thread, type of protection: IP 68 up to 10 bar

◀ Fortsetzung von vorheriger Seite  
Continued from previous page

Anschlussgewinde Connection thread	Messing vernickelt Brass, nickel-plated			Edelstahl 1.4305 Stainless steel AISI 303			Polycarbonat Polycarbonate	
	A	Druckschraube (DS) Pressure screw (DS)	Doppelnippel (DN) Double nipple (DN)	Verschraubungs- körper (VK) Gland body (VK)	Druckschraube (DS) Pressure screw (DS)	Doppelnippel (DN) Double nipple (DN)	Verschraubungs- körper (VK) Gland body (VK)	Druckschraube (DS) Pressure screw (DS)
Pg 21		DS 152d	DN 15452d	VK 15452d				
Pg 21		DS 153d	DN 15453d	VK 15453d				
Pg 21		DS 154d18	DN 154d	VK 154d	DS 154st18	DN 154st	VK 154st	DS 154PC
Pg 21		DS 154d21	DN 154d	VK 154d20	DS 154st21	DN 154st	VK 154st20	DS 154PC
Pg 21		DS 155d	DN 15455d	VK 15455d				
Pg 21								
Pg 29		DS 153d	DN 15553d	VK 15553d				
Pg 29		DS 154d18	DN 15554d	VK 15554d				
Pg 29		DS 155d	DN 155d	VK 155d	DS 155st	DN 155st	VK 155st	DS 155PC
Pg 29		DS 156d	DN 15556d	VK 15556d				DS 156PC
Pg 36		DS 155d	DN 15655d	VK 15655d				
Pg 36		DS 156d	DN 156d	VK 156d	DS 156st	DN 156st	VK 156st	DS 156PC
Pg 36		DS 157d	DN 15657d	VK 15657d				
Pg 42		DS 157d	DN 157d	VK 157d	DS 157st	DN 157st	VK 157st	
Pg 48		DS 158d	DN 158d	VK 158d	DS 158st	DN 158st	VK 158st	

\* Werkstoff POM (Farbe Weiß), Temperaturbereich: –40 °C bis +110 °C.

\* Material POM (white), temperature range: –40 °C up to +110 °C.

Polycarbonat Polycarbonate		PVDF PVDF			Dichteinsätze Sealing inserts			
Doppelnippel (DN) Double nipple (DN)	Verschraubungs- körper (VK) Gland body (VK)	Druckschraube (DS) Pressure screw (DS)	Doppelnippel (DN) Double nipple (DN)	Verschraubungs- körper (VK) Gland body (VK)	TPE	TPE-V	Silikon Silicone	TPE – geschlossen TPE – closed
					E 152/ 7	E 152p 7	E 152i 7/HT	E 152g
					E 152/ 8	E 152p 8	E 152i 8/HT	
					E 152/ 9	E 152p 9	E 152i 9/HT	
					E 153/ 7	E 153p 7	E 153i 7/HT	E 153g
					E 153/ 8	E 153p 8	E 153i 8/HT	
					E 153/ 9	E 153p 9	E 153i 9/HT	
DN 154PC	VK 154PC	DS 154y	DN 154y	VK 154y	E 154/11	E 154p11	E 154i11/HT	E 154g
					E 154/13	E 154p13	E 154i13/HT	
					E 154/16	E 154p16	E 154i16/HT	
					E 154/18	E 154p18	E 154i18/HT	
DN 154PC	VK 154PC	DS 154y	DN 154y	VK 154y	E 154/20	E 154p20	E 154i20/HT	E 154g
					Ek155/25	Ek155p25	E 155i25 HF/HT	Ek155g
					Ek155/28	Ek155p28	E 155i28 HF/HT	
		DS 156y	DN 15456y	VK 15456y	Ek156/32	Ek156p32	E 156i32 HF/HT	Ek156g
					Ek156/34	Ek156p34	E 156i34 HF/HT	
					Ek156/36	Ek156p36	E 156i36 HF/HT	
					E 153/ 7	E 153p 7	E 153i 7/HT	E 153g
					E 153/ 8	E 153p 8	E 153i 8/HT	
					E 153/ 9	E 153p 9	E 153i 9/HT	
					E 153/11	E 153p11	E 153i11/HT	
					E 153/13	E 153p13	E 153i13/HT	
					Ek154/11	Ek154p11	E 154i11/HT	Ek154g
					Ek154/13	Ek154p13	E 154i13 HF/HT	
DN 155PC	VK 155PC	DS 155y	DN 155y	VK 155y	E 155/16	E 155p16	E 153i16/HT	E 155g
					E 155/18	E 155p18	E 155i18/HT	
					E 155/20	E 155p20	E 155i20/HT	
					E 155/25	E 155p25	E 155i25/HT	
					E 155/28	E 155p28	E 155i28/HT	
DN 15556PC	VK 15556PC	DS 156y	DN 15556y	VK 15556y	Ek156/32	Ek156p32	E 156i32 HF/HT	Ek156g
					Ek156/34	Ek156p34	E 156i34 HF/HT	
					Ek156/36	Ek156p36	E 156i36 HF/HT	
					E 155/16	E 155p16	E 155i16/HT	E 155g
					E 155/18	E 155p18	E 155i18/HT	
					E 155/20	E 155p20	E 155i20/HT	
					E 155/25	E 155p25	E 155i25/HT	
					E 155/28	E 155p28	E 155i28/HT	
DN 156PC	VK 156PC	DS 156y	DN 156y	VK 156y	E 156/32	E 156p32	E 156i32/HT	E 156g
					E 156/34	E 156p34	E 156i34/HT	
					E 156/36	E 156p36	E 156i36/HT	
					E 157/40 HF	E 157p40 HF		Ek157g
		DS 157p *	DN 157p *	VK 157p *	E 157/40	E 157p40		E 157g
		DS 158p *	DN 158p *	VK 158y	E 158/44	E 158p44		E 158g



**WAGNER GMBH**  
Elektrotechnische Systemlösungen

Robert-Bosch-Straße 35  
42489 Wülfrath  
T 02058 - 78 28 00 - 0

F 02058 - 78 28 00 - 49  
info@wagnergmbh.de  
www.wagnergmbh.de