

11



Robert-Bosch-Straße 35
42489 Wülfrath
T 02058 - 78 28 00 - 0

F 02058 - 78 28 00 - 49
info@wagnergmbh.de
www.wagnergmbh.de

Winkel + Flansche *Elbows + flanges*



Sicher um die Ecke
Safely around corners



1

Abb. 1 – UNI Kabelverschraubungswinkel – Zinkdruckguss
Fig. 1 – UNI elbow cable gland – zinc die casting

Praktische Winkelverschraubungen

Die Realisierung abgewinkelter Kabeleinführungen ist mit dem umfassenden PFLITSCH Winkelprogramm problemlos möglich. Diese Kabelverschraubungen verfügen über einen um 90° gewinkelten Verschraubungskörper aus Zinkdruckguss oder Polycarbonat, der die beinahe gleichen technischen Werte erreicht wie die UNI Dicht Kabelverschraubung.

Über eine Kupplung oder eine integrierte Gegenmutter lassen sich die Winkelbauteile um 360° in jeder Position ausrichten, sodass eine optimale Kabelführung erreicht wird.

Ebenso verfügbar sind verschiedene Flanschwinkel aus Zinkdruckguss und Polycarbonat, um Kabel im rechten Winkel aus Schalt-schränken oder Maschinengehäusen zu führen. Ein eingelegter O-Ring dichtet den Flansch zum Gehäuse hin ab. Das aus dem Flanschwinkel ausgeführte Kabel wird mit einer Kabelverschraubung sicher abgedichtet.

Practical elbow glands

You can implement angled cable entries without any problem thanks to PFLITSCH's comprehensive range of elbows. These cable glands have a right-angled body made of zinc die casting or polycarbonate, which achieves roughly the same technical specifications as the UNI Dicht standard cable gland.

The elbow can be turned 360° and aligned in any position means of a coupling or an integrated lock nut for optimal cable routing.

Various flange elbows made of zinc die casting and polycarbonate are also available for feeding cables at right angles out of control cabinets or enclosures. An integral o-ring seals the gap between the flange and the enclosure while a gland seals the cable at the point of exit.



1



2

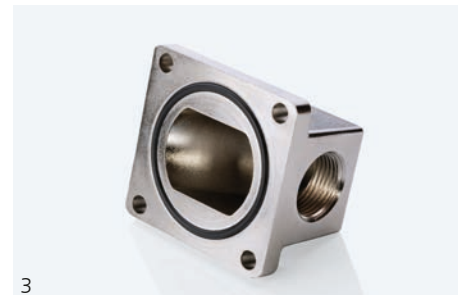

3



4

Abb. 1 – UNI Kabelverschraubungswinkel – Polycarbonat
Fig. 1 – UNI elbow cable gland – polycarbonate

Abb. 2 – Winkel mit Kupplung
Fig. 2 – Elbow with coupling

Abb. 3 – Flanschseite mit O-Ring
Fig. 3 – Flange side with o-ring

Abb. 4 – Flanschwinkel mit Kabelverschraubung
Fig. 4 – Flange elbow with cable gland

UNI Kabelverschraubungswinkel

UNI elbow cable gland



Abb. 1
Fig. 1



Abb. 2
Fig. 2

Zinkdruckguss/Messing vernickelt
Metrisches Anschlussgewinde nach EN 60423
Mit O-Ring aus HNBR
Schutzart IP 68
Zugentlastung bis Klasse A, EN 62444

Zinc die casting/brass, nickel-plated
 Metric connection thread according to EN 60423
 With o-ring made of HNBR
 Type of protection IP 68
 Strain relief up to class A, EN 62444

i Montage: um 360° positionierbar durch Gegenmutter
 Assembly: lock nut allows 360° rotation

Werkstoff Verschraubungskörper Material gland body	Ausführung/Farbe Version/colour	Werkstoff Dichteinsatz Material sealing insert	Farbe Colour	Bestellschlüssel Art. no. supplement	Temperaturbereich min./max. Temperature range (min./max.)
Zinkdruckguss Zinc die casting	Vernickelt Nickel-plated	TPE	s. FC See CC		-40 °C / +130 °C
Zinkdruckguss Zinc die casting	Vernickelt Nickel-plated	TPE-V	Natur Natural	p	-40 °C / +135 °C
Zinkdruckguss Zinc die casting	Vernickelt Nickel-plated	Silikon HT Silicone HT	Schwarz Black	H	-55 °C / +200 °C



Abb. 3
Fig. 3

Anschlussgewinde/-länge Connection thread/length	Art.-Nr. Art. no.	Dichtbereich Sealing range	Länge Length	Bauhöhe Mounting height	Schlüsselweite Spanner width	Schlüsselweite Spanner width			
Ausführung bitte ergänzen Please indicate product details									
A	TPE = TPE-V = p Silikon HT/Silicone HT = H	max./min. ø	C4	C5	SW₀	SW₁ x E₁/SW₂ x E₂			
	mm	mm	mm	mm	mm	mm			
M16x1,5	8,0	21650 VW	7	6,5– 4,0	42,0	25,0	18	20x22,2/17x18,9	50
		21650 VW	8	8,0– 5,0	42,0	25,0	18	20x22,2/17x18,9	50
		21650 VW	9	9,5– 6,5	42,0	25,0	18	20x22,2/17x18,9	50
M20x1,5	8,0	22052 VW	7	6,5– 4,0	48,0	32,0	24	24x26,7/22x24,4	25
		22052 VW	8	8,0– 5,0	48,0	32,0	24	24x26,7/22x24,4	25
		22052 VW	9	9,5– 6,5	48,0	32,0	24	24x26,7/22x24,4	25
		22052 VW	11	10,5– 7,0	48,0	32,0	24	24x26,7/22x24,4	25
		22052 VW	13	13,0– 9,0	48,0	32,0	24	24x26,7/22x24,4	25
M25x1,5	8,0	22553 VW	7	6,5– 4,0	49,0	35,0	26	28x31,2/24x26,7	25
		22553 VW	8	8,0– 5,0	49,0	35,0	26	28x31,2/24x26,7	25
		22553 VW	9	9,5– 6,5	49,0	35,0	26	28x31,2/24x26,7	25
		22553 VW	11	10,5– 7,0	49,0	35,0	26	28x31,2/24x26,7	25
		22553 VW	13	13,0– 9,0	49,0	35,0	26	28x31,2/24x26,7	25
		22553 VW	16	15,5– 11,5	49,0	35,0	26	28x31,2/24x26,7	25

08085001100003

UNI Kabelverschraubungswinkel – Kunststoff

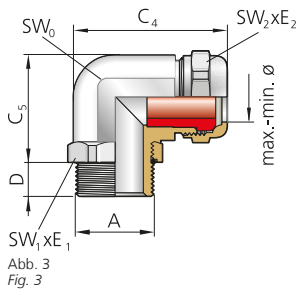
UNI elbow cable gland – Plastic



Abb. 1
Fig. 1

Abb. 2
Fig. 2

Polycarbonat, Farbe: Grau (RAL 7035), Schwarz (RAL 9005)
Metrisches Anschlussgewinde nach EN 60423
Schutzart IP 68 bis 10 bar (zum Kabel)
Zugentlastung bis Klasse A, EN 62444

Polycarbonate, colour: grey (RAL 7035), black (RAL 9005)
Metric connection thread according to EN 60423
Type of protection IP 68 up to 10 bar (at cable)
Strain relief up to class A, EN 62444

Werkstoff Verschraubungskörper Material gland body	Ausführung/Farbe Version/colour	Bestellschlüssel Art. no. supplement	Werkstoff Dichteinsatz Material sealing insert	Farbe Colour	Bestellschlüssel Art. no. supplement	Temperaturbereich min./max. Temperature range (min./max.)
PC	Grau Grey		TPE	s. FC See CC		-20 °C / +100 °C
PC	Grau Grey		TPE-V	Natur Natural	p	-20 °C / +100 °C
PC	Grau Grey		Silikon HT Silicone HT	Schwarz Black	H	-20 °C / +100 °C
PC	Schwarz Black	n	TPE	s. FC See CC		-20 °C / +100 °C
PC	Schwarz Black	n	TPE-V	Natur Natural	p	-20 °C / +100 °C
PC	Schwarz Black	n	Silikon HT Silicone HT	Schwarz Black	H	-20 °C / +100 °C



Abb. 3
Fig. 3

Anschlussgewinde/-länge Connection thread/ length	Art.-Nr. Art. no.	Dichtbereich Sealing range	Bauhöhe Mounting height	Schlüssel- weite Spanner width	Außen- durchmes- ser Outside diameter	Schlüssel- weite Spanner width
Ausführung bitte ergänzen Please indicate product details						
A	D	Grau/Grey = p = TPE Schwarz/Black = n H = Silikon HT/Silicone HT	max./min. ø	C	B	SW₀
	mm		mm	mm	mm	mm
M16x1,5	8,0	21650PCw	7	6,5– 4,0	23,0	38,0
		21650PCw	8	8,0– 5,0	23,0	38,0
		21650PCw	9	9,5– 6,5	23,0	38,0
M20x1,5	9,0	22052PCw	7	6,5– 4,0	28,0	46,0
		22052PCw	8	8,0– 5,0	28,0	46,0
		22052PCw	9	9,5– 6,5	28,0	46,0
		22052PCw	11	10,5– 7,0	28,0	46,0
		22052PCw	13	13,0– 9,0	28,0	46,0
M25x1,5	10,0	22553PCw	7	6,5– 4,0	32,0	52,0
		22553PCw	8	8,0– 5,0	32,0	52,0
		22553PCw	9	9,5– 6,5	32,0	52,0
		22553PCw	11	10,5– 7,0	32,0	52,0
		22553PCw	13	13,0– 9,0	32,0	52,0
		22553PCw	16	15,5– 11,5	32,0	52,0

i Schutzart IP 68 ausschließlich in Verbindung mit separat erhältlicher Flachdichtung auf Seite 407
 Type of protection IP 68 only in combination with separately available flat gasket on page 407

Technische Details und Informationen zu Zulassungen ab Seite 419
 For technical details and information on certifications, see page 419 ff.

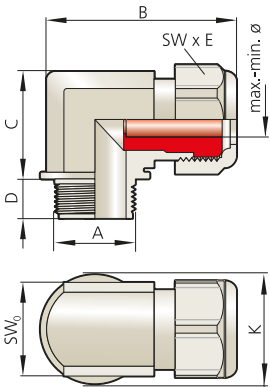
Winkel mit Kupplung

Elbow with coupling

RoHS



Zinkdruckguss
Metrisches Anschlussgewinde nach EN 60423
Mit O-Ring aus HNBR
Schutzart IP 68 bis 10 bar

Zinc die casting
 Metric connection thread according to EN 60423
 With o-ring made of HNBR
 Type of protection IP 68 up to 10 bar

Abb. 1
Fig. 1

i **Ausrichtbarer 90°-Winkel, Ausrichtung um 360° für jede Zwischenposition durch demontierbare Kupplung**
 Alignable right angle, 360° rotation for each intermediate position using demountable coupling

Werkstoff Verschraubungskörper

Material gland body

Zinkdruckguss
 Zinc die casting

Ausführung/Farbe

Version/colour

Verzinkt
 Zinc plated

Kupplung Messing vernickelt
 Coupling nickel-plated brass



Abb. 2
Fig. 2

Anschlussgewinde/-länge Connection thread/length		Art.-Nr. Art. no.	Innengewinde Female thread	Bauhöhe Mounting height	Länge Length	Schlüsselweite Spanner width	Schlüsselweite Spanner width
A	D mm		E mm	C mm	F mm	SW ₀ mm	SW x E mm
M16x1,5	6,0	216 EF	M16x1,5	40,0	25	20	18x20
M20x1,5	6,5	220 EF	M20x1,5	47,0	30	24	22x24,4
M25x1,5	7,0	225 EF	M25x1,5	52,0	35	30	28x31,2
M32x1,5	8,0	232 EF	M32x1,5	64,0	45	38	35x38,5

34000 | TT06100

Kupplung

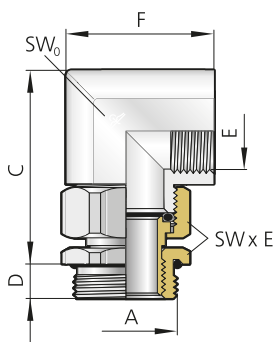
Coupling

RoHS



Messing vernickelt
Metrisches Anschlussgewinde nach EN 60423
Mit O-Ring aus HNBR
Schutzart IP 68 bis 10 bar

Brass, nickel-plated
 Metric connection thread according to EN 60423
 With o-ring made of HNBR
 Type of protection IP 68 up to 10 bar

Abb. 1
Fig. 1

i **Kupplung Messing vernickelt zum Ausrichten und Montieren von vorkonfektionierten Kabel- und Schlauchverschraubungen oder Winkeln**
 Nickel-plated brass coupling for aligning and installing pre-assembled cable and hose glands or elbows

Werkstoff Verschraubungskörper

Material gland body

Messing
 Brass

Ausführung/Farbe

Version/colour

Vernickelt
 Nickel-plated

Schutzart

Type of protection

IP 68



Abb. 2
Fig. 2

Anschlussgewinde/-länge Connection thread/length		Art.-Nr. Art. no.	Bauhöhe Mounting height	Innendurchmesser Inside diameter	Schlüsselweite Spanner width
A	D mm		C mm	E mm	SW x E mm
M16x1,5	6,0	216 MEF	14,0	9,0	18x20
M20x1,5	6,5	220 MEF	14,0	12,0	22x24,4
M25x1,5	7,0	225 MEF	15,0	15,0	28x31,2
M32x1,5	8,0	232 MEF	18,0	18,5	35x38,5

34100 | TT06200

Technische Details und Informationen zu Zulassungen ab Seite 419
 For technical details and information on certifications, see page 419 ff.

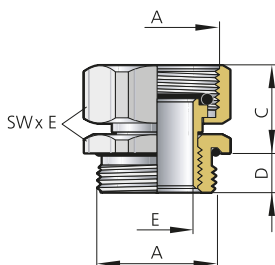
Winkel metrisch

Elbow metric

RoHS



Zinkdruckguss
Metrisches Anschlussgewinde nach EN 60423
Mit O-Ring aus HNBR
Schutzart IP 65

Zinc die casting
Metric connection thread according to EN 60423
With o-ring made of HNBR
Type of protection IP 65

Abb. 1
Fig. 1

Werkstoff Verschraubungskörper
Material gland body

Zinkdruckguss
Zinc die casting

Ausführung/Farbe
Version/colour

Verzinkt
Zinc plated

Temperaturbereich min./max.
Temperature range (min./max.)

-40 °C / +150 °C



Abb. 2
Fig. 2

Anschlussgewinde/-länge <i>Connection thread/length</i>	Art.-Nr. <i>Art. no.</i>	Bauhöhe <i>Mounting height</i>		Schlüsselweite <i>Spanner width</i>		
		A	D	C	H	SW ₀
		mm	mm	mm	mm	mm
M16x1,5	216 F	7,0	25,0	15,0	20	25
M20x1,5	220 F	7,0	30,0	18,0	24	25
M25x1,5	225 F	7,0	35,0	20,0	30	25
M32x1,5	232 F	10,0	45,0	26,0	38	10

34200 | IT06500

Flanschwinkel

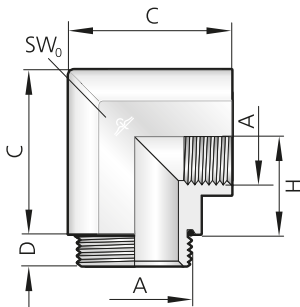
Flange elbow

RoHS



Abb. 1
Fig. 1



Abb. 2
Fig. 2

Zinkdruckguss, kurze Ausführung
Metrisches Anschlussgewinde nach EN 60423
Mit O-Ring aus HNBR
Schutzart IP 68 bis 10 bar

Zinc die casting, short version
Metric connection thread according to EN 60423
With o-ring made of HNBR
Type of protection IP 68 up to 10 bar

Werkstoff Verschraubungskörper
Material gland body

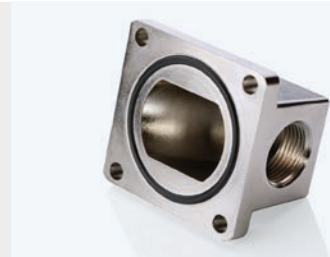
Zinkdruckguss
Zinc die casting

Ausführung/Farbe
Version/colour

Vernickelt
Nickel-plated

Temperaturbereich min./max.
Temperature range (min./max.)

-40 °C / +150 °C



Abb. 3
Fig. 3

Anschlussgewinde Connection thread	Art.-Nr. Art. no.	B mm	L mm	H mm	E mm	F mm	G mm	
M16x1,5	216 W	45	48	30,0	37,0	4x4,3	15,5	10
M20x1,5	220 W	53	56	35,0	44,0	4x5,5	18,0	10
M25x1,5	225 W	63	65	42,0	54,0	4x5,5	22,5	10
M32x1,5	232 W	71	75	52,0	60,0	4x5,5	27,0	5
M40x1,5	240 W	71	75	52,0	60,0	4x5,5	27,0	5
M50x1,5	250 W	89	93	69,0	72,0	4x6,5	33,5	2
M63x1,5	263 W	96	114	74,0	84,0	4x6,5	37,0	1

344600 | TT06600

Flanschwinkel – Kunststoff

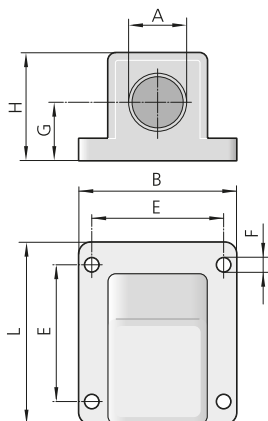
Flange elbow – Plastic

RoHS



Abb. 1
Fig. 1



Abb. 2
Fig. 2

Polycarbonat, Farbe: Grau (RAL 7035), Schwarz (RAL 9005)
Metrisches Anschlussgewinde nach EN 60423
Mit O-Ring aus HNBR
Schutzart IP 68 bis 10 bar

Polycarbonate, colour: grey (RAL 7035), black (RAL 9005)
Metric connection thread according to EN 60423
With o-ring made of HNBR
Type of protection IP 68 up to 10 bar

Werkstoff Verschraubungskörper
Material gland body

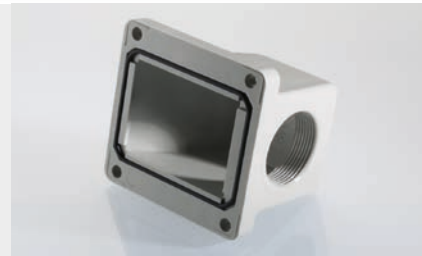
PC

PC

Ausführung/Farbe
Version/colour

Grau
Grey

Schwarz
Black

Bestellschlüssel
Art. no. supplement

n

Temperaturbereich min./max.
Temperature range (min./max.)

-20 °C / +100 °C

-20 °C / +100 °C



Abb. 3
Fig. 3

Anschlussgewinde Connection thread	Art.-Nr. Art. no.	B mm	L mm	H mm	E mm	F mm	G mm	
M16x1,5	FWPC 216	45	50	29,0	37,0	4x4,5	15,5	10
M20x1,5	FWPC 220	53	56	35,0	44,0	4x5,5	20,0	10
M25x1,5	FWPC 225	68	68	43,0	55,0	4x5,5	24,0	10
M32x1,5	FWPC 232	70	74	52,0	60,0	4x5,5	26,0	5
M40x1,5	FWPC 240	70	74	52,0	60,0	4x5,5	26,0	5
M50x1,5	FWPC 250	88	93	68,0	72,0	4x6,5	34,0	2

Ausführung bitte ergänzen
Please indicate product details

Grau/Grey =
Schwarz/Black = n

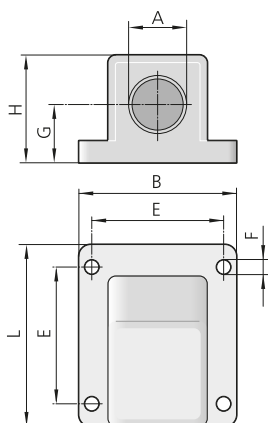
344800 | TT06610

Technische Details und Informationen zu Zulassungen ab Seite 419
For technical details and information on certifications, see page 419 ff.

UNI Kabelverschraubungswinkel Pg

UNI elbow cable gland Pg

RoHS



Abb. 1
Fig. 1



Abb. 2
Fig. 2

Zinkdruckguss/Messing vernickelt
Pg-Anschlussgewinde
Mit O-Ring aus HNBR
Schutzart IP 68
Zugentlastung bis Klasse A, EN 62444

Zinc die casting/brass, nickel-plated
Pg connection thread
With o-ring made of HNBR
Type of protection IP 68
Strain relief up to class A, EN 62444

i Montage: um 360° positionierbar durch Gegenmutter
Assembly: lock nut allows 360° rotation

Werkstoff Verschraubungskörper Material gland body	Ausführung/Farbe Version/colour	Werkstoff Dichteinsatz Material sealing insert	Farbe Colour	Bestellschlüssel Art. no. supplement	Temperaturbereich min./max. Temperature range (min./max.)
Zinkdruckguss Zinc die casting	Vernickelt Nickel-plated	TPE	s. FC See CC		-40 °C / +130 °C
Zinkdruckguss Zinc die casting	Vernickelt Nickel-plated	TPE-V	Natur Natural	p	-40 °C / +135 °C
Zinkdruckguss Zinc die casting	Vernickelt Nickel-plated	Silikon HT Silicone HT	Schwarz Black	H	-55 °C / +200 °C



Abb. 3
Fig. 3

Anschlussgewinde-länge Connection thread/length		Art.-Nr. Art. no.	Dichtbereich Sealing range	Länge Length	Bauhöhe Mounting height	Schlüsselweite Spanner width	Schlüsselweite Spanner width		
Ausführung bitte ergänzen Please indicate product details									
A	D mm	TPE =	max./min. ø	C4	C5	SW ₀	SW ₁ x E ₁ /SW ₂ x E ₂		
		TPE-V = p							
		Silikon HT/Silicone HT = H							
Pg 9	8,5	9 VW	7	6,5– 4,0	41,0	24,5	18	18x20/17x18,9	25
		9 VW	8	8,0– 5,0	41,0	24,5	18	18x20/17x18,9	25
		9 VW	9	9,5– 6,5	41,0	24,5	18	18x20/17x18,9	25
Pg 11	8,0	11 VW	7	6,5– 4,0	43,4	27,0	20	22x24,4/20x22,2	25
		11 VW	8	8,0– 5,0	43,4	27,0	20	22x24,4/20x22,2	25
		11 VW	9	9,5– 6,5	43,4	27,0	20	22x24,4/20x22,2	25
		11 VW	11	10,5– 7,0	43,4	27,0	20	22x24,4/20x22,2	25
Pg 13	8,0	13 VW	7	6,5– 4,0	46,6	31,0	24	28x31/22x24,4	25
		13 VW	8	8,0– 5,0	46,6	31,0	24	28x31/22x24,4	25
		13 VW	9	9,5– 6,5	46,6	31,0	24	28x31/22x24,4	25
		13 VW	11	10,5– 7,0	46,6	31,0	24	28x31/22x24,4	25
		13 VW	13	13,0– 9,0	46,6	31,0	24	28x31/22x24,4	25
Pg 16	8,0	16 VW	7	6,5– 4,0	48,7	33,0	26	30x33,5/24x26,7	25
		16 VW	8	8,0– 5,0	48,7	33,0	26	30x33,5/24x26,7	25
		16 VW	9	9,5– 6,5	48,7	33,0	26	30x33,5/24x26,7	25
		16 VW	11	10,5– 7,0	48,7	33,0	26	30x33,5/24x26,7	25
		16 VW	13	13,0– 9,0	48,7	33,0	26	30x33,5/24x26,7	25
		16 VW	16	15,5– 11,5	48,7	33,0	26	30x33,5/24x26,7	25
Pg 21	10,0	21 VW	11	10,5– 7,0	59,5	39,5	30	35x38,5/30x33,5	10
		21 VW	13	13,0– 9,0	59,5	39,5	30	35x38,5/30x33,5	10
		21 VW	16	15,5– 11,5	59,5	39,5	30	35x38,5/30x33,5	10
		21 VW	18	18,0– 14,0	59,5	39,5	30	35x38,5/30x33,5	10
		21 VW	21	20,5– 17,0	59,5	39,5	30	35x38,5/30x33,5	10

331001 | IT05800

Technische Details und Informationen zu Zulassungen ab Seite 419
For technical details and information on certifications, see page 419 ff.

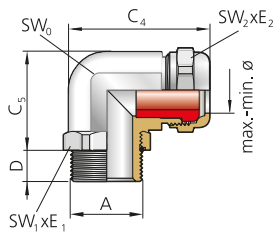
UNI Kabelverschraubungswinkel – Kunststoff Pg

UNI elbow cable gland – Plastic Pg

RoHS



Abb. 1
Fig. 1

Abb. 2
Fig. 2

Polycarbonat, Farbe: Grau (RAL 7035), Schwarz (RAL 9005)
Pg-Anschlussgewinde
Schutzart IP 68 bis 10 bar (zum Kabel)
Zugentlastung bis Klasse A, EN 62444

Polycarbonate, colour: grey (RAL 7035), black (RAL 9005)
 Pg connection thread
 Type of protection IP 68 up to 10 bar (at cable)
 Strain relief up to class A, EN 62444

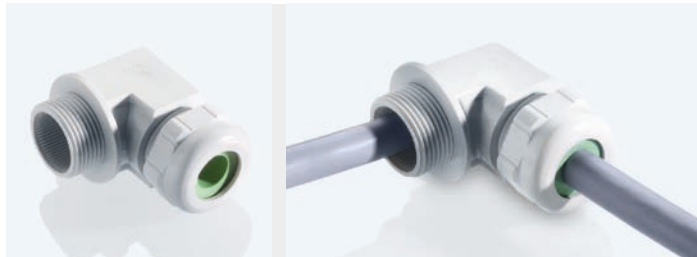
Werkstoff Verschraubungskörper Material gland body	Ausführung/Farbe Version/colour	Bestellschlüssel Art. no. supplement	Werkstoff Dichteinsatz Material sealing insert	Farbe Colour	Bestellschlüssel Art. no. supplement	Temperaturbereich min./max. Temperature range (min./max.)
PC	Grau Grey		TPE	s. FC See CC		-20 °C / +100 °C
PC	Grau Grey		TPE-V	Natur Natural	p	-20 °C / +100 °C
PC	Grau Grey		Silikon HT Silicone HT	Gelb Yellow	H	-20 °C / +100 °C
PC	Schwarz Black	n	TPE	s. FC See CC		-20 °C / +100 °C
PC	Schwarz Black	n	TPE-V	Natur Natural	p	-20 °C / +100 °C
PC	Schwarz Black	n	Silikon HT Silicone HT	Schwarz Black	H	-20 °C / +100 °C

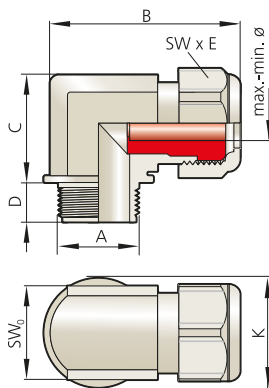

Abb. 3
Fig. 3

Anschlussgewinde/-länge Connection thread/ length	Art.-Nr. Art. no.	Dichtbereich Sealing range	Bauhöhe Mounting height	Schlüssel- weite Spanner width	Außendurch- messer Outside diameter	Schlüssel- weite Spanner width			
Ausführung bitte ergänzen Please indicate product details									
A	D	Grau/Grey = p Schwarz/Black = n	= TPE = TPE-V = Silikon HT/Silicone HT	max./min. ø	C	B	SW₀	Ø K	SW x E
Pg 9	8,0			mm	mm	mm	mm	mm	mm
Pg 11	9,0			mm	mm	mm	mm	mm	mm
Pg 13,5	9,0			mm	mm	mm	mm	mm	mm
Pg 16	10,0			mm	mm	mm	mm	mm	mm

i Schutzart IP 68 ausschließlich in Verbindung mit separat erhältlicher Flachdichtung auf Seite 407
 Type of protection IP 68 only in combination with separately available flat gasket on page 407