















Inhalt		Seite
	Hauptschalter für Einbau 4-Lochbefestigung	280
	Umschalter mit Sperrvorrichtung für Einbau 4-Lochbefestigung	281
	Hauptschalter für Zentralbefestigung	281
	Hauptschalter für Bodenmontage	282
	Hauptschalter-Not-Aus für Einbau 4-Lochbefestigung	286
	Umschalter mit Sperrvorrichtung für Einbau 4-Lochbefestigung	287
	Hauptschalter-Not-Aus für Zentralbefestigung	287
	Hauptschalter-Not-Aus für Bodenmontage	288
	Hauptschalter-Not-Aus für Reiheneinbau	290
	Umschalter mit Sperrvorrichtung für Reiheneinbau	290
	Reparaturschalter, isolierstoffgekapselt	291
	Umschalter mit Sperrvorrichtung	291
	Lasttrennschalter für Einbau, Ein-Ausschalter	292
	Lasttrennschalter für Zentralbefestigung, Ein-Ausschalter	293
	Lasttrennschalter für Bodenmontage	293
	Lasttrennschalter für Reiheneinbau	295
	Lasttrennschalter für Einbau, isolierstoffgekapselt	296
	Zusatzmodule	297
	Technische Daten	299
	Maße	300

Nennwerte									Einbau 4-Lochbefestigung IP66	Zentralbefestigung Ø22,5mm IP66			
				Schutzart von vorne im eingebauten Zustand									
Typ	Nennbetriebsstrom			Motor				Schild mm	EH4	EHN4	EHN1Z	ZHN1	ZH1
	Therm. I _{th} A	offen AC21 A	bei U _e V	AC3 3~400V kW	AC23 3~400V A	AC21 3~400V kW	AC21 3~400V kW						
LTS20	20	20	690	5,5	16	7,5	13,8	48□	LTS20 E ¹⁾ ..		LTS20 Z ¹⁾ ..		
LTS25	25	25	690	7,5	20	10	17,3	48□	LTS25 E ¹⁾ ..		LTS25 Z ¹⁾ ..		
LTS32	32	32	690	11	25	12,5	22,1	48□	LTS32 E ¹⁾ ..		LTS32 Z ¹⁾ ..		
LTS40	40	40	690	15	32	16	27,6	48□	LTS40 E ¹⁾ ..		LTS40 Z ¹⁾ ..		
LTS63	63	63	690	18,5	45	22	43,6	48□	LTS63 E ¹⁾ ..		-		
LTS80	80	80	690	18,5	45	22	55,3	48□	LTS80 E ¹⁾ ..		-		
LTS85	85	85	690	22	60	30	58,8	64□	LTS85 E ¹⁾ ..		-		
LTS100	100	100	690	30	72	37	69,2	64□	LTS100 E ¹⁾ ..		-		
LTS125	125	125	690	37	85	45	86,5	64□	LTS125 E ¹⁾ ..		-		
LT160	160	160	690	45	110	55	110	88□	LT160 E ¹⁾ ..		-		

Lasttrennschalter LT(S).. 20 - 160A

Der Einsatzbereich der Lasttrennschalter ist überall dort gegeben, wo kompakte EIN-AUS-Schalter mit großer Kontaktöffnung (Trenner) und hohem Kontaktdruck und damit größerer Kurzschlußfestigkeit benötigt werden. Die Anwendung erfolgt daher als

Hauptschalter nach IEC/EN 60204 bzw. VDE0113 mit Sperrvorrichtung, Klemmenabdeckung und zwangsweiser Kontaktbetätigung.

Trennschalter nach IEC/EN 60947-3 und VDE 0660 Teil 107 mit Trennstrecken für 690V.

Motorschalter 3-polig oder 4-polig. Entsprechend IEC/EN 60947-3 bzw. VDE 0660 Teil 107 haben die Schalter der LT(S)-Reihe hohes AC3- und AC23A-Schaltvermögen.

Schaltprogramme

Ein-Ausschalter 3-polig	A3
Ein-Ausschalter 4-polig	A4
Ein-Ausschalter 6-polig	A6
Ein-Ausschalter 8-polig	A8
Umschalter mit 0-Stellung 3-polig	U3
Umschalter mit 0-Stellung 4-polig	U4
Ein-Ausschalter 3-polig	T300 (für LT160)
Ein-Ausschalter 4-polig	T400 (für LT160)

Zulässige Einbaulage von Schaltern:

Keine Einschränkungen

1) Hauptschalter (H1/H4 Hauptschalter Not-Aus (HN1/HN4))
Lasttrennschalter (ohne H(N)1/4)

Hauptschalter und Hauptschalter mit Not-Aus-Funktion

Jede Be- und Verarbeitungsmaschine muß nach den Vorschriften IEC/EN 60204 bzw. VDE0113 mit einem Hauptschalter ausgerüstet sein, der die gesamte elektrische Ausrüstung während Reinigungs-, Wartungs- und Reparaturarbeiten sowie bei längeren Stillstandszeiten von allen aktiven Leitern der Netzeinspeisung trennt.

Sind 2 oder mehr Hauptschalter vorgesehen, müssen entsprechende Schutzverriegelungen verwendet werden. Empfehlenswert ist jedoch die Verwendung eines vielpoligen Hauptschalters (Nockenschalter).

Der **Hauptschalter** muß einer der folgenden Arten entsprechen:

- Lasttrennschalter entsprechend IEC/EN 60947-3 und VDE 0660 Teil 107 für Anwendungskategorie AC23-B oder DC-23B.
- Trennschalter mit Hilfskontakt (z.B.: Schaltprogramm A3-10), der auf jeden Fall veranlaßt, daß Schalteinrichtungen die Last vor dem Öffnen der Hauptkontakte des Trenners abschalten.
- Das Ausschaltvermögen muß ausreichend sein, den Strom des größten Motors im blockierten Zustand zusammen mit der Summe der Betriebsströme aller übrigen Motoren und/oder Verbraucher abzuschalten.

Anforderungen:

Trennen der elektrischen Ausrüstung vom Netz, wobei nur eine Aus- und eine Ein-Stellung vorhanden ist, eindeutig gekennzeichnet mit O und I. Er muß in der Aus-Stellung abschließbar sein.

Die Netzklemmen eines Hauptschalters müssen gegen zufälliges Berühren mindestens der Schutzart IP2X entsprechen.

Farbe der Handhabe schwarz oder grau.

Der **Hauptschalter mit Not-Aus-Funktion** muß zusätzlich mit einem roten Schaltergriff ausgerüstet sein, das Frontschild hinter dem Schaltergriff muß gelb gefärbt sein, damit sich der Griff deutlich abhebt.

Verteilereinbau mit Türkupplung Griff Zentralbefestigung Ø22,5mm IP66	Verteilereinbau m. Türkupplung Einbau 4-Lochbefestigung IP66	Reiheneinbau IP40	Preßstoff- gekapselt IP66
---	--	----------------------	---------------------------------



VZVH4	VZVHN4	VZVHN1	VH4	VHN4	VH1	SMA	SMAHN1	SMAH1	PF(L ²)H4	PF(L ²)HN4	PF(L ²)
LTS20 VZV ¹⁾ ..			LTS20 V ¹⁾ ..			LTS20 SMA ¹⁾ ..			LTS20 PF(L ²) ¹⁾ ..		
LTS25 VZV ¹⁾ ..			LTS25 V ¹⁾ ..			LTS25 SMA ¹⁾ ..			LTS25 PF(L ²) ¹⁾ ..		
LTS32 VZV ¹⁾ ..			LTS32 V ¹⁾ ..			LTS32 SMA ¹⁾ ..			LTS32 PF(L ²) ¹⁾ ..		
LTS40 VZV ¹⁾ ..			LTS40 V ¹⁾ ..			LTS40 SMA ¹⁾ ..			LTS40 PF(L ²) ¹⁾ ..		
LTS63 VZV ¹⁾ ..			LTS63 V ¹⁾ ..			LTS63 SMA ¹⁾ ..			LTS63 PFL ¹⁾ ..		
LTS80 VZV ¹⁾ ..			LTS80 V ¹⁾ ..			LTS80 SMA ¹⁾ ..			LTS80 PFL ¹⁾ ..		
LTS85 VZV ¹⁾ ..			LTS85 V ¹⁾ ..			LTS85 SMA ¹⁾ ..			LTS85 PFL ¹⁾ ..		
LTS100 VZV ¹⁾ ..			LTS100 V ¹⁾ ..			LTS100 SMA ¹⁾ ..			LTS100 PFL ¹⁾ ..		
LTS125 VZV ¹⁾ ..			LTS125 V ¹⁾ ..			LTS125 SMA ¹⁾ ..			LTS125 PFL ¹⁾ ..		
-			LT160 V ¹⁾ ..			-			LT160 PF ¹⁾ .. ³⁾		

Approbationen

Land	USA, Kanada / UL	Europa	Russland / EAC	CB/CCA-Zertifikate
Typ				

Lasttrennschalter (UL-Listed as MANUAL MOTOR CONTROLLER and suitable as MOTOR DISCONNECT)	USA, Kanada / UL	Europa	Russland / EAC	CB/CCA-Zertifikate
LTS20	o	/	o	o
LTS25	o	/	o	o
LTS32	o	/	o	o
LTS40	o	/	o	o
LTS63	o	/	o	o
LTS80	o	/	o	o
LTS85	o	/	-	-
LTS100	o	/	-	-
LTS125	o	/	-	-
LT160	o	/	-	o

o in Normalausführung approbiert
/ Approbation nicht erforderlich CE
x zur Approbation eingereicht
- bisher nicht zur Approbation vorgesehen



Klemmenanschlußschrauben



Geräte	Anschlußart	Schraubendreher	Anzugsdrehmoment	Schutzart
Typ	Schraube mit Zugbügel		Nm	der Anschlußklemmen ⁴⁾
Lasttrennschalter				
LTS20, LTS25	M3,5		1,7 - 2,3	IP20
LTS32, LTS40	M5		2,8 - 4	IP20
LTS63, LTS80	M6		1,7 - 4,5	IP20
LTS85, LTS100, LTS125				IP20
LT160	M10		14	IP20



1) Hauptschalter (H1/H4 Hauptschalter Not-Aus (HN1/HN4)) und Lasttrennschalter (ohne H(N)1/4)
2) PFL... größeres Gehäuse
3) IP. Type..
4) Schutzart mit angeschlossenem, isoliertem Leiter. Zusatzschutz durch entsprechende Klemmenabdeckung (KLAD).

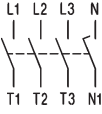

Schütze, Motorstarter
Leistungsschalter
Motorschutzschalter
Schalter
AC-Hauptschalter
DC-Lasttrennschalter
Befehls- und Meldegeräte
Vertretungen, Bezugsquellen

Hauptschalter für Einbau 4-Lochbefestigung, absperrbar IP66, Type 3R

	max. Schösser	AC21 690V	AC23 3x400V	Schild	Typ	VPE Stk.	Gewicht kg/Stk.
3-polig, Sperrvorrichtung SV1   		20A	7,5kW	48 □ ¹⁾	LTS20 EH1 A3	1	0,15
		25A	10kW	48 □ ¹⁾	LTS25 EH1 A3	1	0,15
		32A	12,5kW	48 □ ¹⁾	LTS32 EH1 A3	1	0,15
		40A	16kW	48 □ ¹⁾	LTS40 EH1 A3	1	0,15
		63A	22kW	48 □ ¹⁾	LTS63 EH1 A3	1	0,17
		80A	22kW	48 □ ¹⁾	LTS80 EH1 A3	1	0,17

4-polig, Sperrvorrichtung SV1   		20A	7,5kW	48 □ ¹⁾	LTS20 EH1 A4	1	0,19
		25A	10kW	48 □ ¹⁾	LTS25 EH1 A4	1	0,19
		32A	12,5kW	48 □ ¹⁾	LTS32 EH1 A4	1	0,19
		40A	16kW	48 □ ¹⁾	LTS40 EH1 A4	1	0,19
		63A	22kW	48 □ ¹⁾	LTS63 EH1 A4	1	0,21
		80A	22kW	48 □ ¹⁾	LTS80 EH1 A4	1	0,21

3-polig, Sperrvorrichtung SV4(34)   		20A	7,5kW	64 □ ²⁾	LTS20 EH4 A3	1	0,17
		25A	10kW	64 □ ²⁾	LTS25 EH4 A3	1	0,17
		32A	12,5kW	64 □ ²⁾	LTS32 EH4 A3	1	0,17
		40A	16kW	64 □ ²⁾	LTS40 EH4 A3	1	0,17
		63A	22kW	64 □ ²⁾	LTS63 EH4 A3	1	0,19
		80A	22kW	64 □ ²⁾	LTS80 EH4 A3	1	0,19
		85A	30kW	64 □ ²⁾	LTS85 EH4 A3	1	0,39
		100A	37kW	64 □ ²⁾	LTS100 EH4 A3	1	0,39
		125A	45kW	64 □ ²⁾	LTS125 EH4 A3	1	0,39
		160A	55kW	88 □	LT160 EH34 T300	1	1,16

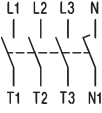
4-polig, Sperrvorrichtung SV4(34)   		20A	7,5kW	64 □ ²⁾	LTS20 EH4 A4	1	0,20
		25A	10kW	64 □ ²⁾	LTS25 EH4 A4	1	0,20
		32A	12,5kW	64 □ ²⁾	LTS32 EH4 A4	1	0,20
		40A	16kW	64 □ ²⁾	LTS40 EH4 A4	1	0,20
		63A	22kW	64 □ ²⁾	LTS63 EH4 A4	1	0,23
		80A	22kW	64 □ ²⁾	LTS80 EH4 A4	1	0,23
		85A	30kW	64 □ ²⁾	LTS85 EH4 A4	1	0,44
		100A	37kW	64 □ ²⁾	LTS100 EH4 A4	1	0,44
		125A	45kW	64 □ ²⁾	LTS125 EH4 A4	1	0,44
		160A	55kW	88 □	LT160 EH34 T400	1	1,55

Zusatzmodule siehe Seite 297





Verlängerte Schalterwelle für Schalter für Fronteinbau Typenzusatz: **+VW“x“**

x = Paneelstärke



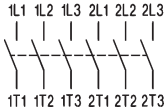

1) Auf Anfrage auch in Schildgröße 64 □ erhältlich, Typenzusatz **64** z. B: LTS32 EHN164 A3

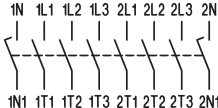
2) Auf Anfrage auch in Schildgröße 88 □ erhältlich, Typenzusatz **88** z. B: LTS32 EHN488 A3



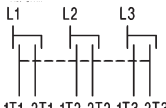

Hauptschalter für Einbau 4-Lochbefestigung, absperrrbar IP66, Type 3R

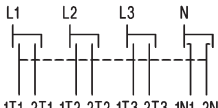
		max. Schlösser	AC21 690V	AC23 3x400V	Schild	Typ	VPE Stk.	Gewicht kg/Stk.
6-polig, Sperrvorrichtung SV4 								
			20A	7,5kW	64 □	LTS20 EH4 A6	1	0,30
			25A	10kW	64 □	LTS25 EH4 A6	1	0,30
			32A	12,5kW	64 □	LTS32 EH4 A6	1	0,30
			40A	16kW	64 □	LTS40 EH4 A6	1	0,30
			63A	22kW	64 □	LTS63 EH4 A6	1	0,34
			80A	22kW	64 □	LTS80 EH4 A6	1	0,34
8-polig, Sperrvorrichtung SV4 								
			20A	7,5kW	64 □	LTS20 EH4 A8	1	0,38
			25A	10kW	64 □	LTS25 EH4 A8	1	0,38
			32A	12,5kW	64 □	LTS32 EH4 A8	1	0,38
			40A	16kW	64 □	LTS40 EH4 A8	1	0,38
			63A	22kW	64 □	LTS63 EH4 A8	1	0,42
			80A	22kW	64 □	LTS80 EH4 A8	1	0,42

Umschalter mit Sperrvorrichtung für Einbau 4-Lochbefestigung, absperrrbar IP66

		max. Schlösser	AC21 690V	AC23 3x400V	Schild	Typ	VPE Stk.	Gewicht kg/Stk.
3-polig, Sperrvorrichtung SV4 								
			20A	7,5kW	64 □	LTS20 EH4 U3	1	0,30
			25A	10kW	64 □	LTS25 EH4 U3	1	0,30
			32A	12,5kW	64 □	LTS32 EH4 U3	1	0,30
			40A	16kW	64 □	LTS40 EH4 U3	1	0,30
			63A	22kW	64 □	LTS63 EH4 U3	1	0,34
4-polig, Sperrvorrichtung SV4 								
			20A	7,5kW	64 □	LTS20 EH4 U4	1	0,38
			25A	10kW	64 □	LTS25 EH4 U4	1	0,38
			32A	12,5kW	64 □	LTS32 EH4 U4	1	0,38
			40A	16kW	64 □	LTS40 EH4 U4	1	0,38
			63A	22kW	64 □	LTS63 EH4 U4	1	0,42

Hauptschalter für Zentralbefestigung, absperrrbar IP66, Type 4X

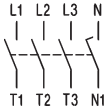
		max. Schlösser	AC21 690V	AC23 3x400V	Schild	Typ	VPE Stk.	Gewicht kg/Stk.
3-polig, Sperrvorrichtung SV1 								
			20A	7,5kW	48 □	LTS20 ZH1 A3	1	0,16
			25A	10kW	48 □	LTS25 ZH1 A3	1	0,16
			32A	12,5kW	48 □	LTS32 ZH1 A3	1	0,16
			40A	16kW	48 □	LTS40 ZH1 A3	1	0,16
4-polig, Sperrvorrichtung SV1 								
			20A	7,5kW	48 □	LTS20 ZH1 A4	1	0,20
			25A	10kW	48 □	LTS25 ZH1 A4	1	0,20
			32A	12,5kW	48 □	LTS32 ZH1 A4	1	0,20
			40A	16kW	48 □	LTS40 ZH1 A4	1	0,20

Zusatzmodule siehe Seite 297

Hauptschalter, Bodenmontage mit Türkupplung, Sperrvorrichtung für Zentralbefestigung Ø22mm
Einbautiefe nachträglich einstellbar (Lieferlänge, X_{max} siehe unten) IP66, cUL_{us} Type 4X

	max. Schösser	AC21 690V	AC23 3x400V	Schild	Typ	VPE Stk.	Gewicht kg/Stk.
3-polig, Sperrvorrichtung SV4 							
		20A	7,5kW	64 □	LTS20 VZVH4 A3	1	0,19
		25A	10kW	64 □	LTS25 VZVH4 A3	1	0,19
		32A	12,5kW	64 □	LTS32 VZVH4 A3	1	0,19
		40A	16kW	64 □	LTS40 VZVH4 A3	1	0,19
		63A	22kW	64 □	LTS63 VZVH4 A3	1	0,22
		80A	22kW	64 □	LTS80 VZVH4 A3	1	0,22
		85A	30kW	64 □	LTS85 VZVH4 A3	1	0,40
		100A	37kW	64 □	LTS100 VZVH4 A3	1	0,40
		125A	45kW	64 □	LTS125 VZVH4 A3	1	0,40

	max. Schösser	AC21 690V	AC23 3x400V	Schild	Typ	VPE Stk.	Gewicht kg/Stk.
4-polig, Sperrvorrichtung SV4 							
		20A	7,5kW	64 □	LTS20 VZVH4 A4	1	0,20
		25A	10kW	64 □	LTS25 VZVH4 A4	1	0,20
		32A	12,5kW	64 □	LTS32 VZVH4 A4	1	0,20
		40A	16kW	64 □	LTS40 VZVH4 A4	1	0,20
		63A	22kW	64 □	LTS63 VZVH4 A4	1	0,26
		80A	22kW	64 □	LTS80 VZVH4 A4	1	0,26
		85A	30kW	64 □	LTS85 VZVH4 A4	1	0,45
		100A	37kW	64 □	LTS100 VZVH4 A4	1	0,45
		125A	45kW	64 □	LTS125 VZVH4 A4	1	0,45

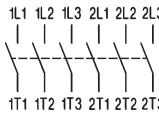
	max. Schösser	AC21 690V	AC23 3x400V	Schild	Typ	VPE Stk.	Gewicht kg/Stk.
6-polig, Sperrvorrichtung SV4 							
		20A	7,5kW	64 □	LTS20 VZVH4 A6	1	0,32
		25A	10kW	64 □	LTS25 VZVH4 A6	1	0,32
		32A	12,5kW	64 □	LTS32 VZVH4 A6	1	0,32
		40A	16kW	64 □	LTS40 VZVH4 A6	1	0,32
		63A	22kW	64 □	LTS63 VZVH4 A6	1	0,37
		80A	22kW	64 □	LTS80 VZVH4 A6	1	0,37

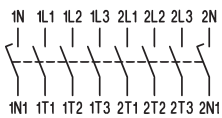
	max. Schösser	AC21 690V	AC23 3x400V	Schild	Typ	VPE Stk.	Gewicht kg/Stk.
8-polig, Sperrvorrichtung SV4 							
		20A	7,5kW	64 □	LTS20 VZVH4 A8	1	0,34
		25A	10kW	64 □	LTS25 VZVH4 A8	1	0,34
		32A	12,5kW	64 □	LTS32 VZVH4 A8	1	0,34
		40A	16kW	64 □	LTS40 VZVH4 A8	1	0,34
		63A	22kW	64 □	LTS63 VZVH4 A8	1	0,45
		80A	22kW	64 □	LTS80 VZVH4 A8	1	0,45

Einbautiefe
Zentralbefestigung Ø22mm
LTS.. VZV..

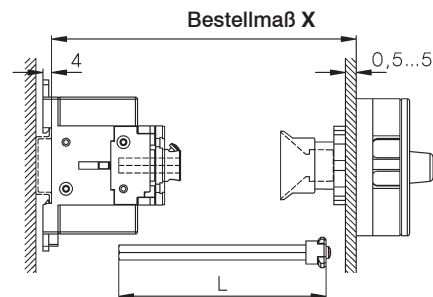

Typ		X min	X max	L
LTS20-80 VZV..	3, 4-polig	91	190	X - 40±3
LTS20-80 VZV..	6, 8-polig	111	190	X - 60±3
LTS85-125 VZV..	3, 4-polig	95	190	X - 44±3

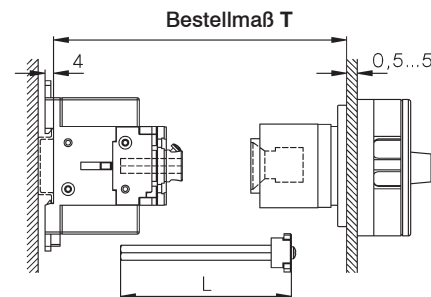

4-Lochbefestigung
LTS.. V(H).. (3, 4-polig)





Typ		T min	T max	L	Type	T min	T max
LTS20-80 VH..		111	190	T - 60±3	LTS160 VH..	120	450
LTS85-125 VH..		115	190	T - 64±3			



Größere X- und T-Maße (max. 380mm für LTS..) auf Anfrage

Hauptschalter, Bodenmontage mit Türkupplung, Sperrvorrichtung für 4-Lochbefestigung
 Einbautiefe nachträglich einstellbar (Lieferlänge, T_{max} siehe Seite 282) IP66, cUL_{us} Type 4X

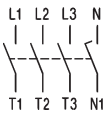
	max. Schösser	AC21 690V	AC23 3x400V	Schild	Typ	VPE Stk.	Gewicht kg/Stk.
3-polig, Sperrvorrichtung SV4(34) 							
 	20A	7,5kW		64 □ ¹⁾	LTS20 VH4 A3	1	0,20
	25A	10kW		64 □ ¹⁾	LTS25 VH4 A3	1	0,20
	32A	12,5kW		64 □ ¹⁾	LTS32 VH4 A3	1	0,20
	40A	16kW		64 □ ¹⁾	LTS40 VH4 A3	1	0,20
	63A	22kW		64 □ ¹⁾	LTS63 VH4 A3	1	0,24
	80A	22kW		64 □ ¹⁾	LTS80 VH4 A3	1	0,24
	85A	30kW		64 □ ¹⁾	LTS85 VH4 A3	1	0,40
	100A	37kW		64 □ ¹⁾	LTS100 VH4 A3	1	0,40
	125A	45kW		64 □ ¹⁾	LTS125 VH4 A3	1	0,40
	160A	55kW		88 □	LT160 VH34 T300	1	1,38

4-polig, Sperrvorrichtung SV4(34) 							
 	20A	7,5kW		64 □ ¹⁾	LTS20 VH4 A4	1	0,21
	25A	10kW		64 □ ¹⁾	LTS25 VH4 A4	1	0,21
	32A	12,5kW		64 □ ¹⁾	LTS32 VH4 A4	1	0,21
	40A	16kW		64 □ ¹⁾	LTS40 VH4 A4	1	0,21
	63A	22kW		64 □ ¹⁾	LTS63 VH4 A4	1	0,28
	80A	22kW		64 □ ¹⁾	LTS80 VH4 A4	1	0,28
	85A	30kW		64 □ ¹⁾	LTS85 VH4 A4	1	0,45
	100A	37kW		64 □ ¹⁾	LTS100 VH4 A4	1	0,45
	125A	45kW		64 □ ¹⁾	LTS125 VH4 A4	1	0,45
	160A	55kW		88 □	LT160 VH34 T400	1	1,77

Hauptschalter, Bodenmontage mit Stecktürkupplung für Zentralbefestigung Ø22mm
 Einbautiefe nicht einstellbar, Maß X bei Bestellung angeben IP66, cUL_{us} Type 4X

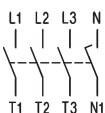
4-polig, Sperrvorrichtung SV4 							
 	20A	7,5kW		64 □	LTS20 VZH4 A4 X..	1	0,18
	25A	10kW		64 □	LTS25 VZH4 A4 X..	1	0,18
	32A	12,5kW		64 □	LTS32 VZH4 A4 X..	1	0,18
	40A	16kW		64 □	LTS40 VZH4 A4 X..	1	0,18
	63A	22kW		64 □	LTS63 VZH4 A4 X..	1	0,25
	80A	22kW		64 □	LTS80 VZH4 A4 X..	1	0,25

Einbautiefe Maß X unbedingt angeben

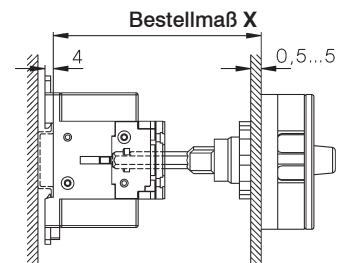

Typ	Vorzugswerte für X
LT.. VZH..	80, 85, 104, 129 (Toleranz -3, +1,5)





Zusatzmodule siehe Seite 297

1) Auf Anfrage auch in Schildgröße 88 □ erhältlich Typenzusatz **88** z. B: LTS32 VH4**88** A3



Hauptschalter, für Reiheneinbau, absperrrbar IP40,  Open Type

	max. Schlösser	AC21 690V	AC23 3x400V	Schild	Typ	VPE Stk.	Gewicht kg/Stk.
3-polig, Sperrvorrichtung SV1 							
		20A	7,5kW	52x45	LTS20 SMAH1 A3 ²⁾	1	0,15
		25A	10kW	52x45	LTS25 SMAH1 A3 ²⁾	1	0,15
		32A	12,5kW	52x45	LTS32 SMAH1 A3 ²⁾	1	0,15
		40A	16kW	52x45	LTS40 SMAH1 A3 ²⁾	1	0,15
		63A	22kW	52x45	LTS63 SMAH1 A3 ²⁾	1	0,18
		80A	22kW	52x45	LTS80 SMAH1 A3 ²⁾	1	0,18
		85A	30kW	78x45	LTS85 SMAH1 A3	1	0,37
		100A	37kW	78x45	LTS100 SMAH1 A3	1	0,37
	125A	45kW	78x45	LTS125 SMAH1 A3	1	0,37	



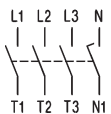

4-polig, Sperrvorrichtung SV1 							
		20A	7,5kW	52x45	LTS20 SMAH1 A4 ²⁾	1	0,16
		25A	10kW	52x45	LTS25 SMAH1 A4 ²⁾	1	0,16
		32A	12,5kW	52x45	LTS32 SMAH1 A4 ²⁾	1	0,16
		40A	16kW	52x45	LTS40 SMAH1 A4 ²⁾	1	0,16
		63A	22kW	52x45	LTS63 SMAH1 A4 ²⁾	1	0,21
		80A	22kW	52x45	LTS80 SMAH1 A4 ²⁾	1	0,21
		85A	30kW	78x45	LTS85 SMAH1 A4	1	0,42
		100A	37kW	78x45	LTS100 SMAH1 A4	1	0,42
	125A	45kW	78x45	LTS125 SMAH1 A4	1	0,42	



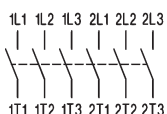

6-polig, Sperrvorrichtung SV1(64) 							
		20A	7,5kW	52x45	LTS20 SMAH1 A6	1	0,29
		25A	10kW	52x45	LTS25 SMAH1 A6	1	0,29
		32A	12,5kW	52x45	LTS32 SMAH1 A6	1	0,29
		40A	16kW	52x45	LTS40 SMAH1 A6	1	0,29
		63A	22kW	97x45	LTS63 SMAH1 A6 ¹⁾	1	0,34
		80A	22kW	97x45	LTS80 SMAH1 A6 ¹⁾	1	0,34



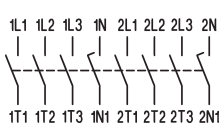

8-polig, Sperrvorrichtung SV164 							
		20A	7,5kW	97x45	LTS20 SMAH1 A8	1	0,31
		25A	10kW	97x45	LTS25 SMAH1 A8	1	0,31
		32A	12,5kW	97x45	LTS32 SMAH1 A8	1	0,31
		40A	16kW	97x45	LTS40 SMAH1 A8	1	0,31
		63A	22kW	126x45	LTS63 SMAH1 A8	1	0,42
		80A	22kW	126x45	LTS80 SMAH1 A8	1	0,42

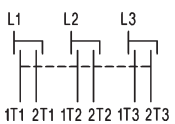

Umschalter mit Sperrvorrichtung für Reiheneinbau, absperrrbar

3-polig, Sperrvorrichtung SV164 							
		20A	7,5kW	97x45	LTS20 SMAH1 U3	1	0,29
		25A	10kW	97x45	LTS25 SMAH1 U3	1	0,29
		32A	12,5kW	97x45	LTS32 SMAH1 U3	1	0,29
		40A	16kW	97x45	LTS40 SMAH1 U3	1	0,29
		63A	22kW	97x45	LTS63 SMAH1 U3	1	0,34

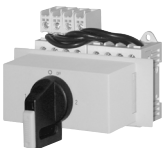

4-polig, Sperrvorrichtung SV164 							
		20A	7,5kW	97x45	LTS20 SMAH1 U4	1	0,31
		25A	10kW	97x45	LTS25 SMAH1 U4	1	0,31
		32A	12,5kW	97x45	LTS32 SMAH1 U4	1	0,31
		40A	16kW	97x45	LTS40 SMAH1 U4	1	0,31
		63A	22kW	126x45	LTS63 SMAH1 U4	1	0,42

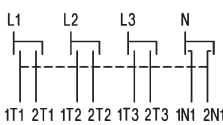













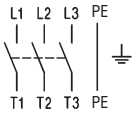



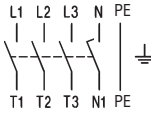



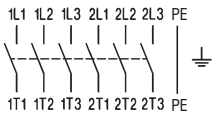

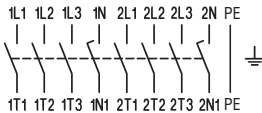

1) mit Sperrvorrichtung SV164

2) **Hauptschalter-Not-Aus, für Reiheneinbau**, absperrrbar mit **niedrigem Griff**, IP40

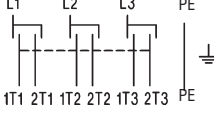

Typ mit Typenzusatz „+SV1N“ z.B.: **LTS40 SMAH1 A3 +SV1**

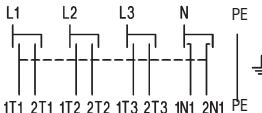
Reparaturschalter isolierstoffgekapselt, absperrbar IP66, c_{UL} Type 4X



	max. Schösser	AC21 690V	AC23 3x400V	Schild	Typ	VPE Stk.	Gewicht kg/Stk.	
3-polig, Sperrvorrichtung SV4(34)   								
 	20A	7,5kW		64 □	LTS20 PF(L ¹)H4 A3	1	0,32	
	25A	10kW		64 □	LTS25 PF(L ¹)H4 A3	1	0,32	
	32A	12,5kW		64 □	LTS32 PF(L ¹)H4 A3	1	0,32	
	40A	16kW		64 □	LTS40 PF(L ¹)H4 A3	1	0,32	
	63A	22kW		64 □	LTS63 PFLH4 A3	1	0,60	
	80A	22kW		64 □	LTS80 PFLH4 A3	1	0,60	
	85A	30kW		64 □	LTS85 PFLH4 A3	1	0,78	
	100A	37kW		64 □	LTS100 PFLH4 A3	1	0,78	
	125A	45kW		64 □	LTS125 PFLH4 A3	1	0,78	
	160A	55kW		88 □	LT160 PFH34 T300	1	2,09	
Größeres Gehäuse Typ: ..PFL..	auf Anfrage							
4-polig, Sperrvorrichtung SV4(34)   								
 	20A	7,5kW		64 □	LTS20 PF(L ¹)H4 A4	1	0,33	
	25A	10kW		64 □	LTS25 PF(L ¹)H4 A4	1	0,33	
	32A	12,5kW		64 □	LTS32 PF(L ¹)H4 A4	1	0,33	
	40A	16kW		64 □	LTS40 PF(L ¹)H4 A4	1	0,33	
	63A	22kW		64 □	LTS63 PFLH4 A4	1	0,64	
	80A	22kW		64 □	LTS80 PFLH4 A4	1	0,64	
	85A	30kW		64 □	LTS85 PFLH4 A4	1	0,83	
	100A	37kW		64 □	LTS100 PFLH4 A4	1	0,83	
	125A	45kW		64 □	LTS125 PFLH4 A4	1	0,83	
	160A	55kW		88 □	LT160 PFH34 T400	1	2,47	
Größeres Gehäuse Typenzusatz +PF3 +PF3/M50	auf Anfrage							
6-polig, Sperrvorrichtung SV4   								
 	20A	7,5kW		64 □	LTS20 PFLH4 A6	1	1,39	
	25A	10kW		64 □	LTS25 PFLH4 A6	1	1,39	
	32A	12,5kW		64 □	LTS32 PFLH4 A6	1	1,39	
	40A	16kW		64 □	LTS40 PFLH4 A6	1	1,39	
	63A	22kW		64 □	LTS63 PFLH4 A6	1	1,42	
	80A	22kW		64 □	LTS80 PFLH4 A6	1	1,42	
	Anbauerschraubung M50/40 +PF3/M50 auf Anfrage							
	8-polig, Sperrvorrichtung SV4   							
	 	20A	7,5kW		64 □	LTS20 PFLH4 A8	1	1,44
		25A	10kW		64 □	LTS25 PFLH4 A8	1	1,44
32A		12,5kW		64 □	LTS32 PFLH4 A8	1	1,44	
40A		16kW		64 □	LTS40 PFLH4 A8	1	1,44	
63A		22kW		64 □	LTS63 PFLH4 A8	1	1,50	
80A		22kW		64 □	LTS80 PFLH4 A8	1	1,50	
Anbauerschraubung M50/40 +PF3/M50 auf Anfrage								
Umschalter mit Sperrvorrichtung, absperrbar								
3-polig, Sperrvorrichtung SV4   								
 		20A	7,5kW		64 □	LTS20 PFLH4 U3	1	1,39
	25A	10kW		64 □	LTS25 PFLH4 U3	1	1,39	
	32A	12,5kW		64 □	LTS32 PFLH4 U3	1	1,39	
	40A	16kW		64 □	LTS40 PFLH4 U3	1	1,39	
	63A	22kW		64 □	LTS63 PFLH4 U3	1	1,42	
	Anbauerschraubung M50/40 +PF3/M50 auf Anfrage							
4-polig, Sperrvorrichtung SV4   								
 	20A	7,5kW		64 □	LTS20 PFLH4 U4	1	1,44	
	25A	10kW		64 □	LTS25 PFLH4 U4	1	1,44	
	32A	12,5kW		64 □	LTS32 PFLH4 U4	1	1,44	
	40A	16kW		64 □	LTS40 PFLH4 U4	1	1,44	
	63A	22kW		64 □	LTS63 PFLH4 U4	1	1,50	
	Anbauerschraubung M50/40 +PF3/M50 auf Anfrage							

1) PFL.... größerer Anschlußraum

Hauptschalter-Not-Aus, für Einbau 4-Lochbefestigung, absperrbar IP66, Type 3R

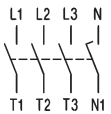
	max. Schösser	AC21 690V	AC23 3x400V	Schild	Typ	VPE Stk.	Gewicht kg/Stk.
3-polig, Sperrvorrichtung SV1  		20A	7,5kW	48 □ ¹⁾	LTS20 EHN1 A3	1	0,15
		25A	10kW	48 □ ¹⁾	LTS25 EHN1 A3	1	0,15
		32A	12,5kW	48 □ ¹⁾	LTS32 EHN1 A3	1	0,15
		40A	16kW	48 □ ¹⁾	LTS40 EHN1 A3	1	0,15
		63A	22kW	48 □ ¹⁾	LTS63 EHN1 A3	1	0,17
		80A	22kW	48 □ ¹⁾	LTS80 EHN1 A3	1	0,17

4-polig, Sperrvorrichtung SV1  		20A	7,5kW	48 □ ¹⁾	LTS20 EHN1 A4	1	0,19
		25A	10kW	48 □ ¹⁾	LTS25 EHN1 A4	1	0,19
		32A	12,5kW	48 □ ¹⁾	LTS32 EHN1 A4	1	0,19
		40A	16kW	48 □ ¹⁾	LTS40 EHN1 A4	1	0,19
		63A	22kW	48 □ ¹⁾	LTS63 EHN1 A4	1	0,21
		80A	22kW	48 □ ¹⁾	LTS80 EHN1 A4	1	0,21

3-polig, Sperrvorrichtung SV4(34)  		20A	7,5kW	64 □ ²⁾	LTS20 EHN4 A3	1	0,17
		25A	10kW	64 □ ²⁾	LTS25 EHN4 A3	1	0,17
		32A	12,5kW	64 □ ²⁾	LTS32 EHN4 A3	1	0,17
		40A	16kW	64 □ ²⁾	LTS40 EHN4 A3	1	0,17
		63A	22kW	64 □ ²⁾	LTS63 EHN4 A3	1	0,19
		80A	22kW	64 □ ²⁾	LTS80 EHN4 A3	1	0,19
		85A	30kW	64 □ ²⁾	LTS85 EHN4 A3	1	0,39
		100A	37kW	64 □ ²⁾	LTS100 EHN4 A3	1	0,39
		125A	45kW	64 □ ²⁾	LTS125 EHN4 A3	1	0,39
		160A	55kW	88 □	LT160 EHN34 T300	1	1,16

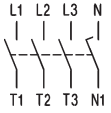
4-polig, Sperrvorrichtung SV4(34)  		20A	7,5kW	64 □ ²⁾	LTS20 EHN4 A4	1	0,20
		25A	10kW	64 □ ²⁾	LTS25 EHN4 A4	1	0,20
		32A	12,5kW	64 □ ²⁾	LTS32 EHN4 A4	1	0,20
		40A	16kW	64 □ ²⁾	LTS40 EHN4 A4	1	0,20
		63A	22kW	64 □ ²⁾	LTS63 EHN4 A4	1	0,23
		80A	22kW	64 □ ²⁾	LTS80 EHN4 A4	1	0,23
		85A	30kW	64 □ ²⁾	LTS85 EHN4 A4	1	0,44
		100A	37kW	64 □ ²⁾	LTS100 EHN4 A4	1	0,44
		125A	45kW	64 □ ²⁾	LTS125 EHN4 A4	1	0,44
		160A	55kW	88 □	LT160 EHN34 T400	1	1,55

Zusatzmodule siehe Seite 297





Verlängerte Schalterwelle für Schalter für Fronteinbau Typenzusatz: **+VW“x“**

x = Paneelstärke

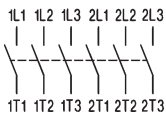

1) Auf Anfrage auch in Schildgröße 64 □ erhältlich, Typenzusatz **64** z. B: LTS32 EHN164 A3

2) Auf Anfrage auch in Schildgröße 88 □ erhältlich, Typenzusatz **88** z. B: LTS32 EHN488 A3

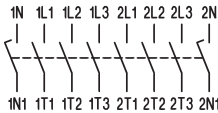

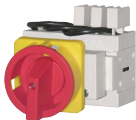
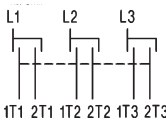

Hauptschalter-Not-Aus, für Einbau 4-Lochbefestigung, absperrbar IP66, Type 3R

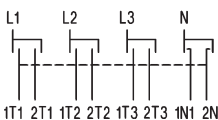
	max. Schlösser	AC21 690V	AC23 3x400V	Schild	Typ	VPE Stk.	Gewicht kg/Stk.
6-polig, Sperrvorrichtung SV4 							
		20A	7,5kW	64 □	LTS20 EHN4 A6	1	0,30
		25A	10kW	64 □	LTS25 EHN4 A6	1	0,30
		32A	12,5kW	64 □	LTS32 EHN4 A6	1	0,30
		40A	16kW	64 □	LTS40 EHN4 A6	1	0,30
		63A	22kW	64 □	LTS63 EHN4 A6	1	0,34
		80A	22kW	64 □	LTS80 EHN4 A6	1	0,34
8-polig, Sperrvorrichtung SV4 							
		20A	7,5kW	64 □	LTS20 EHN4 A8	1	0,38
		25A	10kW	64 □	LTS25 EHN4 A8	1	0,38
		32A	12,5kW	64 □	LTS32 EHN4 A8	1	0,38
		40A	16kW	64 □	LTS40 EHN4 A8	1	0,38
		63A	22kW	64 □	LTS63 EHN4 A8	1	0,42
		80A	22kW	64 □	LTS80 EHN4 A8	1	0,42

Umschalter mit Sperrvorrichtung für Einbau 4-Lochbefestigung, absperrbar IP66

	max. Schlösser	AC21 690V	AC23 3x400V	Schild	Typ	VPE Stk.	Gewicht kg/Stk.
3-polig, Sperrvorrichtung SV4 							
		20A	7,5kW	64 □	LTS20 EHN4 U3	1	0,30
		25A	10kW	64 □	LTS25 EHN4 U3	1	0,30
		32A	12,5kW	64 □	LTS32 EHN4 U3	1	0,30
		40A	16kW	64 □	LTS40 EHN4 U3	1	0,30
		63A	22kW	64 □	LTS63 EHN4 U3	1	0,34
4-polig, Sperrvorrichtung SV4 							
		20A	7,5kW	64 □	LTS20 EHN4 U4	1	0,38
		25A	10kW	64 □	LTS25 EHN4 U4	1	0,38
		32A	12,5kW	64 □	LTS32 EHN4 U4	1	0,38
		40A	16kW	64 □	LTS40 EHN4 U4	1	0,38
		63A	22kW	64 □	LTS63 EHN4 U4	1	0,42

Hauptschalter-Not-Aus, für Zentralbefestigung, absperrbar IP66 Type 4X

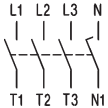
	max. Schlösser	AC21 690V	AC23 3x400V	Schild	Typ	VPE Stk.	Gewicht kg/Stk.
3-polig, Sperrvorrichtung SV1 							
		20A	7,5kW	48 □	LTS20 ZHN1 A3	1	0,16
		25A	10kW	48 □	LTS25 ZHN1 A3	1	0,16
		32A	12,5kW	48 □	LTS32 ZHN1 A3	1	0,16
		40A	16kW	48 □	LTS40 ZHN1 A3	1	0,16
4-polig, Sperrvorrichtung SV1 							
		20A	7,5kW	48 □	LTS20 ZHN1 A4	1	0,20
		25A	10kW	48 □	LTS25 ZHN1 A4	1	0,20
		32A	12,5kW	48 □	LTS32 ZHN1 A4	1	0,20
		40A	16kW	48 □	LTS40 ZHN1 A4	1	0,20

Zusatzmodule siehe Seite 297

Hauptschalter-Not-Aus, Bodenmontage mit Türkupplung für Zentralbefestigung Ø22mm
 Einbautiefe nachträglich einstellbar (Lieferlänge, X_{max} siehe unten) IP66, cUL_{us} Type 4X

	max. Schösser	AC21 690V	AC23 3x400V	Schild	Typ	VPE Stk.	Gewicht kg/Stk.
3-polig, Sperrvorrichtung SV4 							
		20A	7,5kW	64 □	LTS20 VZVHN4 A3	1	0,19
		25A	10kW	64 □	LTS25 VZVHN4 A3	1	0,19
		32A	12,5kW	64 □	LTS32 VZVHN4 A3	1	0,19
		40A	16kW	64 □	LTS40 VZVHN4 A3	1	0,19
		63A	22kW	64 □	LTS63 VZVHN4 A3	1	0,22
		80A	22kW	64 □	LTS80 VZVHN4 A3	1	0,22
		85A	30kW	64 □	LTS85 VZVHN4 A3	1	0,40
		100A	37kW	64 □	LTS100 VZVHN4 A3	1	0,40
		125A	45kW	64 □	LTS125 VZVHN4 A3	1	0,40

	max. Schösser	AC21 690V	AC23 3x400V	Schild	Typ	VPE Stk.	Gewicht kg/Stk.
4-polig, Sperrvorrichtung SV4 							
		20A	7,5kW	64 □	LTS20 VZVHN4 A4	1	0,20
		25A	10kW	64 □	LTS25 VZVHN4 A4	1	0,20
		32A	12,5kW	64 □	LTS32 VZVHN4 A4	1	0,20
		40A	16kW	64 □	LTS40 VZVHN4 A4	1	0,20
		63A	22kW	64 □	LTS63 VZVHN4 A4	1	0,26
		80A	22kW	64 □	LTS80 VZVHN4 A4	1	0,26
		85A	30kW	64 □	LTS85 VZVHN4 A4	1	0,45
		100A	37kW	64 □	LTS100 VZVHN4 A4	1	0,45
		125A	45kW	64 □	LTS125 VZVHN4 A4	1	0,45

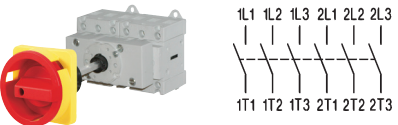
	max. Schösser	AC21 690V	AC23 3x400V	Schild	Typ	VPE Stk.	Gewicht kg/Stk.
6-polig, Sperrvorrichtung SV4 							
		20A	7,5kW	64 □	LTS20 VZVHN4 A6	1	0,32
		25A	10kW	64 □	LTS25 VZVHN4 A6	1	0,32
		32A	12,5kW	64 □	LTS32 VZVHN4 A6	1	0,32
		40A	16kW	64 □	LTS40 VZVHN4 A6	1	0,32
		63A	22kW	64 □	LTS63 VZVHN4 A6	1	0,37
		80A	22kW	64 □	LTS80 VZVHN4 A6	1	0,37

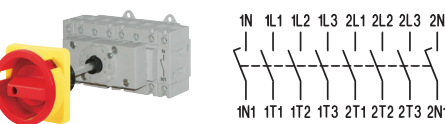
	max. Schösser	AC21 690V	AC23 3x400V	Schild	Typ	VPE Stk.	Gewicht kg/Stk.
8-polig, Sperrvorrichtung SV4 							
		20A	7,5kW	64 □	LTS20 VZVHN4 A8	1	0,34
		25A	10kW	64 □	LTS25 VZVHN4 A8	1	0,34
		32A	12,5kW	64 □	LTS32 VZVHN4 A8	1	0,34
		40A	16kW	64 □	LTS40 VZVHN4 A8	1	0,34
		63A	22kW	64 □	LTS63 VZVHN4 A8	1	0,45
		80A	22kW	64 □	LTS80 VZVHN4 A8	1	0,45

Einbautiefe
 Zentralbefestigung Ø22mm
 LTS.. VZV..

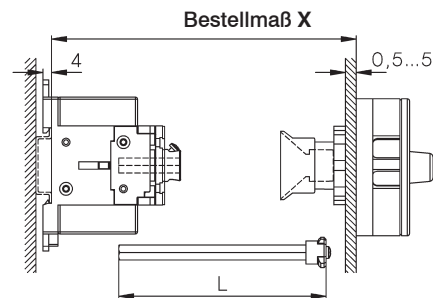

Typ		X min	X max	L
LTS20-80 VZV..	3, 4-polig	91 -	190	X - 40±3
LTS20-80 VZV..	6, 8-polig	111 -	190	X - 60±3
LTS85-125 VZV..	3, 4-polig	95-	190	X - 44±3

4-Lochbefestigung
 LTS.. V(HN).. (3, 4-polig)

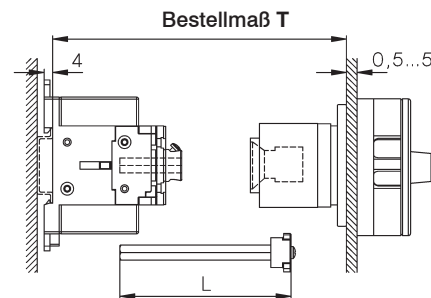

Typ		T min	T max	L	Typ	T min	T max
LTS20-80 VH..		111 -	190	T - 60±3	LTS160 VH..	120 -	450
LTS85-125 VH..		115 -	190	T - 64±3			

Größere X- und T-Maße (max. 380mm für LTS..) auf Anfrage

Hauptschalter-Not-Aus, Bodenmontage mit Türkupplung für 4-Lochbefestigung Einbautiefe nachträglich einstellbar (Lieferlänge, T_{max} siehe Seite 282) IP66, cUL_{us} Type 4X

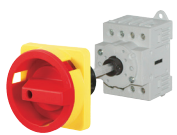
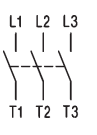
	max. Schösser	AC21 690V	AC23 3x400V	Schild	Typ	VPE Stk.	Gewicht kg/Stk.
3-polig, Sperrvorrichtung SV4(34) $\square\square\square$							
 	20A	7,5kW		64 \square 1)	LTS20 VHN4 A3	1	0,20
	25A	10kW		64 \square 1)	LTS25 VHN4 A3	1	0,20
	32A	12,5kW		64 \square 1)	LTS32 VHN4 A3	1	0,20
	40A	16kW		64 \square 1)	LTS40 VHN4 A3	1	0,20
	63A	22kW		64 \square 1)	LTS63 VHN4 A3	1	0,24
	80A	22kW		64 \square 1)	LTS80 VHN4 A3	1	0,24
	85A	30kW		64 \square 1)	LTS85 VHN4 A3	1	0,40
	100A	37kW		64 \square 1)	LTS100 VHN4 A3	1	0,40
	125A	45kW		64 \square 1)	LTS125 VHN4 A3	1	0,40
	160A	55kW		88 \square	LT160 VHN34 T300	1	1,38

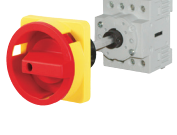
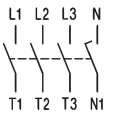
4-polig, Sperrvorrichtung SV4(34) $\square\square\square$							
 	20A	7,5kW		64 \square 1)	LTS20 VHN4 A4	1	0,21
	25A	10kW		64 \square 1)	LTS25 VHN4 A4	1	0,21
	32A	12,5kW		64 \square 1)	LTS32 VHN4 A4	1	0,21
	40A	16kW		64 \square 1)	LTS40 VHN4 A4	1	0,21
	63A	22kW		64 \square 1)	LTS63 VHN4 A4	1	0,28
	80A	22kW		64 \square 1)	LTS80 VHN4 A4	1	0,28
	85A	30kW		64 \square 1)	LTS85 VHN4 A4	1	0,45
	100A	37kW		64 \square 1)	LTS100 VHN4 A4	1	0,45
	125A	45kW		64 \square 1)	LTS125 VHN4 A4	1	0,45
	160A	55kW		88 \square	LT160 VHN34 T400	1	1,77

Hauptschalter-Not-Aus, Bodenmontage mit Stecktürkupplung für Zentralbefestigung $\varnothing 22\text{mm}$ Einbautiefe nicht einstellbar, Maß X bei Bestellung angeben IP66, cUL_{us} Type 4X

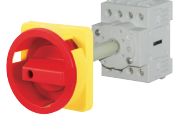
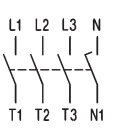
4-polig, Sperrvorrichtung SV4 $\square\square\square$							
 	20A	7,5kW		64 \square	LTS20 VZHN4 A4 X..	1	0,18
	25A	10kW		64 \square	LTS25 VZHN4 A4 X..	1	0,18
	32A	12,5kW		64 \square	LTS32 VZHN4 A4 X..	1	0,18
	40A	16kW		64 \square	LTS40 VZHN4 A4 X..	1	0,18
	63A	22kW		64 \square	LTS63 VZHN4 A4 X..	1	0,25
	80A	22kW		64 \square	LTS80 VZHN4 A4 X..	1	0,25

Einbautiefe Maß X unbedingt angeben

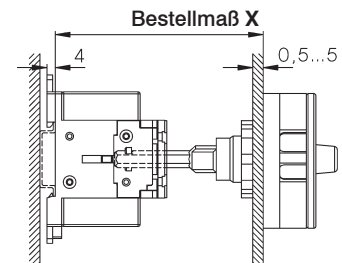

Typ	Vorzugswerte für X
LTS.. VZHN..	80, 85, 104, 129 (Toleranz -3, +1,5)







Zusatzmodule siehe Seite 297



1) Auf Anfrage auch in Schildgröße 88 \square erhältlich Typenzusatz **88** z. B: LTS32 VHN**488** A3

Hauptschalter-Not-Aus, für Reiheneinbau, absperrbar IP40, Open Type

	max. Schlösser	AC21 690V	AC23 3x400V	Schild	Typ	VPE Stk.	Gewicht kg/Stk.	
3-polig, Sperrvorrichtung SV1 								
		20A	7,5kW	52x45	LTS20 SMAHN1 A3 ²⁾	1	0,15	
		25A	10kW	52x45	LTS25 SMAHN1 A3 ²⁾	1	0,15	
		32A	12,5kW	52x45	LTS32 SMAHN1 A3 ²⁾	1	0,15	
			40A	16kW	52x45	LTS40 SMAHN1 A3 ²⁾	1	0,15
			63A	22kW	52x45	LTS63 SMAHN1 A3 ²⁾	1	0,18
			80A	22kW	52x45	LTS80 SMAHN1 A3 ²⁾	1	0,18
			85A	30kW	78x45	LTS85 SMAHN1 A3	1	0,37
			100A	37kW	78x45	LTS100 SMAHN1 A3	1	0,37
		125A	45kW	78x45	LTS125 SMAHN1 A3	1	0,37	

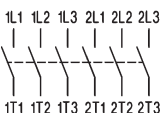
4-polig, Sperrvorrichtung SV1 								
		20A	7,5kW	52x45	LTS20 SMAHN1 A4 ²⁾	1	0,16	
		25A	10kW	52x45	LTS25 SMAHN1 A4 ²⁾	1	0,16	
		32A	12,5kW	52x45	LTS32 SMAHN1 A4 ²⁾	1	0,16	
			40A	16kW	52x45	LTS40 SMAHN1 A4 ²⁾	1	0,16
			63A	22kW	52x45	LTS63 SMAHN1 A4 ²⁾	1	0,21
			80A	22kW	52x45	LTS80 SMAHN1 A4 ²⁾	1	0,21
			85A	30kW	78x45	LTS85 SMAHN1 A4	1	0,42
			100A	37kW	78x45	LTS100 SMAHN1 A4	1	0,42
		125A	45kW	78x45	LTS125 SMAHN1 A4	1	0,42	

6-polig, Sperrvorrichtung SV1(64) 								
		20A	7,5kW	52x45	LTS20 SMAHN1 A6	1	0,29	
		25A	10kW	52x45	LTS25 SMAHN1 A6	1	0,29	
		32A	12,5kW	52x45	LTS32 SMAHN1 A6	1	0,29	
			40A	16kW	52x45	LTS40 SMAHN1 A6	1	0,29
			63A	22kW	97x45	LTS63 SMAHN1 A6 ¹⁾	1	0,34
			80A	22kW	97x45	LTS80 SMAHN1 A6 ¹⁾	1	0,34

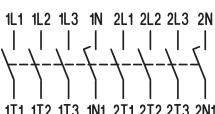
8-polig, Sperrvorrichtung SV164 								
		20A	7,5kW	97x45	LTS20 SMAHN1 A8	1	0,31	
		25A	10kW	97x45	LTS25 SMAHN1 A8	1	0,31	
		32A	12,5kW	97x45	LTS32 SMAHN1 A8	1	0,31	
			40A	16kW	97x45	LTS40 SMAHN1 A8	1	0,31
			63A	22kW	126x45	LTS63 SMAHN1 A8	1	0,42
			80A	22kW	126x45	LTS80 SMAHN1 A8	1	0,42

Umschalter mit Sperrvorrichtung für Reiheneinbau, absperrbar

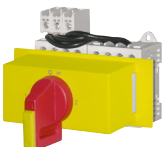
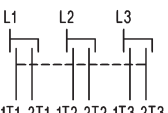
3-polig, Sperrvorrichtung SV164 								
		20A	7,5kW	97x45	LTS20 SMAHN1 U3	1	0,29	
		25A	10kW	97x45	LTS25 SMAHN1 U3	1	0,29	
		32A	12,5kW	97x45	LTS32 SMAHN1 U3	1	0,29	
			40A	16kW	97x45	LTS40 SMAHN1 U3	1	0,29
			63A	22kW	97x45	LTS63 SMAHN1 U3	1	0,34

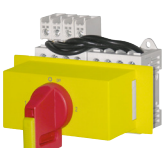
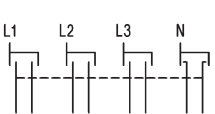











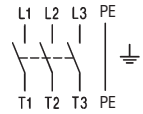













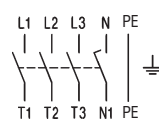













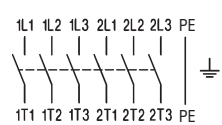









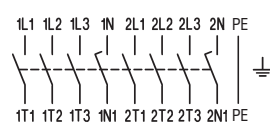









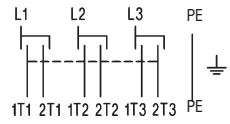



4-polig, Sperrvorrichtung SV164 								
		20A	7,5kW	97x45	LTS20 SMAHN1 U4	1	0,31	
		25A	10kW	97x45	LTS25 SMAHN1 U4	1	0,31	
		32A	12,5kW	97x45	LTS32 SMAHN1 U4	1	0,31	
			40A	16kW	97x45	LTS40 SMAHN1 U4	1	0,31
			63A	22kW	126x45	LTS63 SMAHN1 U4	1	0,42

1) mit Sperrvorrichtung SV164

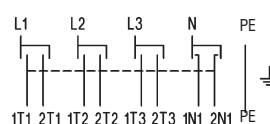
2) Hauptschalter-Not-Aus, für Reiheneinbau, absperrbar mit **niedrigem Griff**, IP40









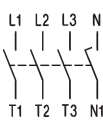

Typ mit Typenzusatz „+SV1RN“ z.B.: **LTS40 SMAHN1 A3 +SV1RN**

Reparaturschalter-Not-Aus isolierstoffgekapselt, absperrbar IP66, Type 4X

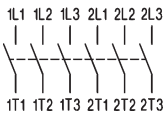

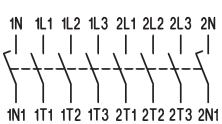
	max. Schösser	AC21 690V	AC23 3x400V	Schild	Typ	VPE Stk.	Gewicht kg/Stk.	
3-polig, Sperrvorrichtung SV4(34)  								
 		20A	7,5kW	64 	LTS20 PF(L ¹)HN4 A3	1	0,32	
		25A	10kW	64 	LTS25 PF(L ¹)HN4 A3	1	0,32	
		32A	12,5kW	64 	LTS32 PF(L ¹)HN4 A3	1	0,32	
		40A	16kW	64 	LTS40 PF(L ¹)HN4 A3	1	0,32	
		63A	22kW	64 	LTS63 PFLHN4 A3	1	0,60	
		80A	22kW	64 	LTS80 PFLHN4 A3	1	0,60	
		85A	30kW	64 	LTS85 PFLHN4 A3	1	0,78	
		100A	37kW	64 	LTS100 PFLHN4 A3	1	0,78	
		125A	45kW	64 	LTS125 PFLHN4 A3	1	0,78	
		160A	55kW	88 	LT160 PFHN34 T300	1	2,09	
Größeres Gehäuse Typ: ..PFL..	auf Anfrage							
4-polig, Sperrvorrichtung SV4(34)  								
 		20A	7,5kW	64 	LTS20 PF(L ¹)HN4 A4	1	0,33	
		25A	10kW	64 	LTS25 PF(L ¹)HN4 A4	1	0,33	
		32A	12,5kW	64 	LTS32 PF(L ¹)HN4 A4	1	0,33	
		40A	16kW	64 	LTS40 PF(L ¹)HN4 A4	1	0,33	
		63A	22kW	64 	LTS63 PFLHN4 A4	1	0,64	
		80A	22kW	64 	LTS80 PFLHN4 A4	1	0,64	
		85A	30kW	64 	LTS85 PFLHN4 A4	1	0,83	
		100A	37kW	64 	LTS100 PFLHN4 A4	1	0,83	
		125A	45kW	64 	LTS125 PFLHN4 A4	1	0,83	
		160A	55kW	88 	LT160 PFHN34 T400	1	2,47	
Größeres Gehäuse Typenzusatz +PF3	auf Anfrage							
+PF3/M50	auf Anfrage							
6-polig, Sperrvorrichtung SV4  								
 		20A	7,5kW	64 	LTS20 PFLHN4 A6	1	1,39	
		25A	10kW	64 	LTS25 PFLHN4 A6	1	1,39	
		32A	12,5kW	64 	LTS32 PFLHN4 A6	1	1,39	
		40A	16kW	64 	LTS40 PFLHN4 A6	1	1,39	
		63A	22kW	64 	LTS63 PFLHN4 A6	1	1,42	
		80A	22kW	64 	LTS80 PFLHN4 A6	1	1,42	
	Anbauerschraubung M50/40	auf Anfrage						
	+PF3/M50	auf Anfrage						
	8-polig, Sperrvorrichtung SV4  							
	 		20A	7,5kW	64 	LTS20 PFLHN4 A8	1	1,44
		25A	10kW	64 	LTS25 PFLHN4 A8	1	1,44	
		32A	12,5kW	64 	LTS32 PFLHN4 A8	1	1,44	
		40A	16kW	64 	LTS40 PFLHN4 A8	1	1,44	
		63A	22kW	64 	LTS63 PFLHN4 A8	1	1,50	
		80A	22kW	64 	LTS80 PFLHN4 A8	1	1,50	
Anbauerschraubung M50/40		auf Anfrage						
+PF3/M50		auf Anfrage						
Umschalter mit Sperrvorrichtung, absperrbar								
3-polig, Sperrvorrichtung SV4  								
 		20A	7,5kW	64 	LTS20 PFLHN4 U3	1	1,39	
		25A	10kW	64 	LTS25 PFLHN4 U3	1	1,39	
		32A	12,5kW	64 	LTS32 PFLHN4 U3	1	1,39	
		40A	16kW	64 	LTS40 PFLHN4 U3	1	1,39	
		63A	22kW	64 	LTS63 PFLHN4 U3	1	1,42	
4-polig, Sperrvorrichtung SV4  								
 		20A	7,5kW	64 	LTS20 PFLHN4 U4	1	1,44	
		25A	10kW	64 	LTS25 PFLHN4 U4	1	1,44	
		32A	12,5kW	64 	LTS32 PFLHN4 U4	1	1,44	
		40A	16kW	64 	LTS40 PFLHN4 U4	1	1,44	
		63A	22kW	64 	LTS63 PFLHN4 U4	1	1,50	

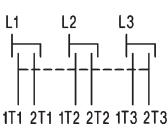
1) PFL..... größerer Anschlußraum

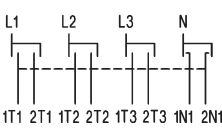

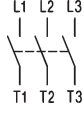

Lasttrennschalter für Einbau, IP66,  Type 3R

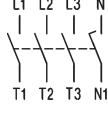
	AC21 690V	AC23 3x400V	Schild	Typ	VPE Stk.	Gewicht kg/Stk.
Ein-Ausschalter 3-polig						
 	20A	7,5kW	48 □	LTS20 E A3	1	0,15
	25A	10kW	48 □	LTS25 E A3	1	0,15
	32A	12,5kW	48 □	LTS32 E A3	1	0,15
	40A	16kW	48 □	LTS40 E A3	1	0,15
	63A	22kW	48 □	LTS63 E A3	1	0,17
	80A	22kW	48 □	LTS80 E A3	1	0,17
	85A	30kW	64 □	LTS85 E A3	1	0,39
	100A	37kW	64 □	LTS100 E A3	1	0,39
	125A	45kW	64 □	LTS125 E A3	1	0,39
	160A	55kW	88 □	LT160 E T300	1	1,10
Ein-Ausschalter 4-polig						
 	20A	7,5kW	48 □	LTS20 E A4	1	0,18
	25A	10kW	48 □	LTS25 E A4	1	0,18
	32A	12,5kW	48 □	LTS32 E A4	1	0,18
	40A	16kW	48 □	LTS40 E A4	1	0,18
	63A	22kW	48 □	LTS63 E A4	1	0,21
	80A	22kW	48 □	LTS80 E A4	1	0,21
	85A	30kW	64 □	LTS85 E A4	1	0,44
	100A	37kW	64 □	LTS100 E A4	1	0,44
	125A	45kW	64 □	LTS125 E A4	1	0,44
	160A	55kW	88 □	LT160 E T400	1	1,50
Ein-Ausschalter 6-polig						
 	20A	7,5kW	64 □	LTS20 E A6	1	0,30
	25A	10kW	64 □	LTS25 E A6	1	0,30
	32A	12,5kW	64 □	LTS32 E A6	1	0,30
	40A	16kW	64 □	LTS40 E A6	1	0,30
	63A	22kW	64 □	LTS63 E A6	1	0,36
	80A	22kW	64 □	LTS80 E A6	1	0,36
Ein-Ausschalter 8-polig						
 	20A	7,5kW	64 □	LTS20 E A8	1	0,32
	25A	10kW	64 □	LTS25 E A8	1	0,32
	32A	12,5kW	64 □	LTS32 E A8	1	0,32
	40A	16kW	64 □	LTS40 E A8	1	0,32
	63A	22kW	64 □	LTS63 E A8	1	0,43
	80A	22kW	64 □	LTS80 E A8	1	0,43
Umschalter 3-polig						
 	20A	7,5kW	64 □	LTS20 E U3	1	0,31
	25A	10kW	64 □	LTS25 E U3	1	0,31
	32A	12,5kW	64 □	LTS32 E U3	1	0,31
	40A	16kW	64 □	LTS40 E U3	1	0,31
	63A	22kW	64 □	LTS63 E U3	1	0,37
	Umschalter 4-polig					
 	20A	7,5kW	64 □	LTS20 E U4	1	0,33
	25A	10kW	64 □	LTS25 E U4	1	0,33
	32A	12,5kW	64 □	LTS32 E U4	1	0,33
	40A	16kW	64 □	LTS40 E U4	1	0,33
	63A	22kW	64 □	LTS63 E U4	1	0,44

Lasttrennschalter für Zentralbefestigung, absperrrbar IP66, Type 4X

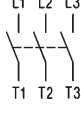
		max. Schlösser	AC21 690V	AC23 3x400V	Schild	Typ	VPE Stk.	Gewicht kg/Stk.
Ein-Ausschalter 3-polig								
 			20A	7,5kW	48 □	LTS20 Z A3	1	0,16
			25A	10kW	48 □	LTS25 Z A3	1	0,16
			32A	12,5kW	48 □	LTS32 Z A3	1	0,16
			40A	16kW	48 □	LTS40 Z A3	1	0,16
	Ein-Ausschalter 4-polig							
 			20A	7,5kW	48 □	LTS20 Z A4	1	0,20
			25A	10kW	48 □	LTS25 Z A4	1	0,20
			32A	12,5kW	48 □	LTS32 Z A4	1	0,20
			40A	16kW	48 □	LTS40 Z A4	1	0,20

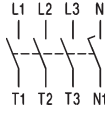
Lasttrennschalter, Bodenmontage mit Türkupplung für Zentralbefestigung Ø22mm Einbautiefe nachträglich einstellbar (Lieferlänge, X_{max} siehe Seite 294) IP66, Type 4X

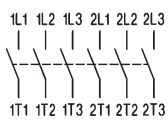
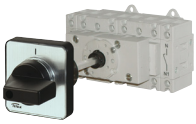
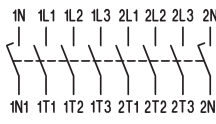
		max. Schlösser	AC21 690V	AC23 3x400V	Schild	Typ	VPE Stk.	Gewicht kg/Stk.
Ein-Ausschalter 3-polig								
 			20A	7,5kW	64 □	LTS20 VZV A3	1	0,19
			25A	10kW	64 □	LTS25 VZV A3	1	0,19
			32A	12,5kW	64 □	LTS32 VZV A3	1	0,19
			40A	16kW	64 □	LTS40 VZV A3	1	0,19
			63A	22kW	64 □	LTS63 VZV A3	1	0,22
			80A	22kW	64 □	LTS80 VZV A3	1	0,22
			85A	30kW	64 □	LTS85 VZV A3	1	0,40
			100A	37kW	64 □	LTS100 VZV A3	1	0,40
			125A	45kW	64 □	LTS125 VZV A3	1	0,40
	Ein-Ausschalter 4-polig							
 			20A	7,5kW	64 □	LTS20 VZV A4	1	0,20
			25A	10kW	64 □	LTS25 VZV A4	1	0,20
			32A	12,5kW	64 □	LTS32 VZV A4	1	0,20
			40A	16kW	64 □	LTS40 VZV A4	1	0,20
			63A	22kW	64 □	LTS63 VZV A4	1	0,26
			80A	22kW	64 □	LTS80 VZV A4	1	0,26
			85A	30kW	64 □	LTS85 VZV A4	1	0,45
			100A	37kW	64 □	LTS100 VZV A4	1	0,45
			125A	45kW	64 □	LTS125 VZV A4	1	0,45
	Ein-Ausschalter 6-polig							
 			20A	7,5kW	64 □	LTS20 VZV A6	1	0,32
			25A	10kW	64 □	LTS25 VZV A6	1	0,32
			32A	12,5kW	64 □	LTS32 VZV A6	1	0,32
			40A	16kW	64 □	LTS40 VZV A6	1	0,32
			63A	22kW	64 □	LTS63 VZV A6	1	0,37
			80A	22kW	64 □	LTS80 VZV A6	1	0,37
	Ein-Ausschalter 8-polig							
 			20A	7,5kW	64 □	LTS20 VZV A8	1	0,34
			25A	10kW	64 □	LTS25 VZV A8	1	0,34
			32A	12,5kW	64 □	LTS32 VZV A8	1	0,34
			40A	16kW	64 □	LTS40 VZV A8	1	0,34
			63A	22kW	64 □	LTS63 VZV A8	1	0,45
			80A	22kW	64 □	LTS80 VZV A8	1	0,45

Lasttrennschalter, Bodenmontage mit Türkupplung für Zentralbefestigung Ø22mm
 Einbautiefe nachträglich einstellbar (Lieferlänge, X_{max} siehe unten) IP66, cUL_{us} Type 4X

Einbautiefe
Zentralbefestigung Ø22mm
LTS.. VZV..

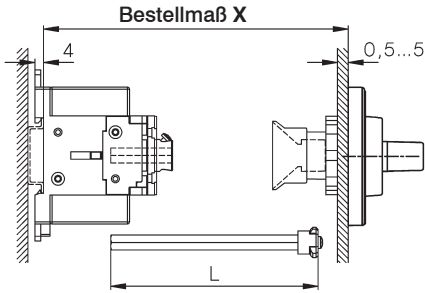

Typ	X min	X max	L
LTS20-80 VZV..	3, 4-polig	91 - 190	X - 40±3
LTS20-80 VZV..	6, 8-polig	111 - 190	X - 60±3
LTS85-125 VZV..	3, 4-polig	95- 190	X - 44±3

4-Lochbefestigung
LTS.. V.. (3, 4-polig)

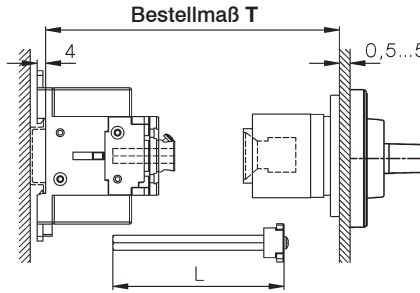

Typ	T min	T max	L	Typ	T min	T max
LTS20-80 V..	111 - 190		T - 60±3	LT160 V..	120 - 450	
LTS85-125 V..	115 - 190		T - 64±3			

größere X- und T-Maße (max. 380mm für LTS..) auf Anfrage

Lasttrennschalter, Bodenmontage mit Türkupplung für 4-Lochbefestigung
 Einbautiefe nachträglich einstellbar (Lieferlänge, T_{max} siehe oben) IP66, cUL_{us} Type 4X

	max. Schösser	AC21 690V	AC23 3x400V	Schild	Typ	VPE Stk.	Gewicht kg/Stk.
--	---------------	-----------	-------------	--------	-----	----------	-----------------

Ein-Ausschalter 3-polig



20A	7,5kW	64 □ ¹⁾	LTS20 V A3	1	0,20
25A	10kW	64 □ ¹⁾	LTS25 V A3	1	0,20
32A	12,5kW	64 □ ¹⁾	LTS32 V A3	1	0,20
40A	16kW	64 □ ¹⁾	LTS40 V A3	1	0,20
63A	22kW	64 □ ¹⁾	LTS63 V A3	1	0,24
80A	22kW	64 □ ¹⁾	LTS80 V A3	1	0,24
85A	30kW	64 □ ¹⁾	LTS85 V A3	1	0,40
100A	37kW	64 □ ¹⁾	LTS100 V A3	1	0,40
125A	45kW	64 □ ¹⁾	LTS125 V A3	1	0,40
160A	55kW	88 □	LT160 V T300	1	1,38

Ein-Ausschalter 4-polig



20A	7,5kW	64 □ ¹⁾	LTS20 V A4	1	0,21
25A	10kW	64 □ ¹⁾	LTS25 V A4	1	0,21
32A	12,5kW	64 □ ¹⁾	LTS32 V A4	1	0,21
40A	16kW	64 □ ¹⁾	LTS40 V A4	1	0,21
63A	22kW	64 □ ¹⁾	LTS63 V A4	1	0,28
80A	22kW	64 □ ¹⁾	LTS80 V A4	1	0,28
85A	30kW	64 □ ¹⁾	LTS85 V A4	1	0,45
100A	37kW	64 □ ¹⁾	LTS100 V A4	1	0,45
125A	45kW	64 □ ¹⁾	LTS125 V A4	1	0,45
160A	55kW	88 □	LT160 V T400	1	1,77

Zusatzmodule siehe Seite 297

1) Auf Anfrage auch in Schildgröße 88 □ erhältlich Typenzusatz **88** z. B: LTS32 VHN**488** A3

Lasttrennschalter, Bodenmontage mit Stecktürkupplung für Zentralbefestigung Ø22mm
Einbautiefe nicht einstellbar, Maß X bei Bestellung angeben IP66,  us Type 4X

	max. Schösser	AC21 690V	AC23 3x400V	Schild	Typ	VPE Stk.	Gewicht kg/Stk.
Ein-Ausschalter 4-polig 		20A	7,5kW	64 □	LTS20 VZ A4 X..	1	0,18
		25A	10kW	64 □	LTS25 VZ A4 X..	1	0,18
		32A	12,5kW	64 □	LTS32 VZ A4 X..	1	0,18
		40A	16kW	64 □	LTS40 VZ A4 X..	1	0,18
		63A	22kW	64 □	LTS63 VZ A4 X..	1	0,25
		80A	22kW	64 □	LTS80 VZ A4 X..	1	0,25

Einbautiefe Maß X unbedingt angeben

Typ **LTS.. VZ..**
Vorzugswerte für X 80, 85, 104, 129 (Toleranz -3, +1,5)

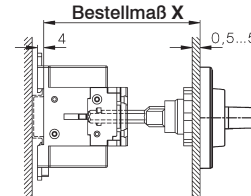



Zusatzmodule siehe Seite 297

Lasttrennschalter für Reiheneinbau IP40,  us Open Type

Ein-Ausschalter 3-polig 	20A	7,5kW	52x45	LTS20 SMA A3	1	0,15
	25A	10kW	52x45	LTS25 SMA A3	1	0,15
	32A	12,5kW	52x45	LTS32 SMA A3	1	0,15
	40A	16kW	52x45	LTS40 SMA A3	1	0,15
	63A	22kW	52x45	LTS63 SMA A3	1	0,17
	80A	22kW	52x45	LTS80 SMA A3	1	0,17

Ein-Ausschalter 4-polig 	20A	7,5kW	52x45	LTS20 SMA A4	1	0,16
	25A	10kW	52x45	LTS25 SMA A4	1	0,16
	32A	12,5kW	52x45	LTS32 SMA A4	1	0,16
	40A	16kW	52x45	LTS40 SMA A4	1	0,16
	63A	22kW	52x45	LTS63 SMA A4	1	0,21
	80A	22kW	52x45	LTS80 SMA A4	1	0,21









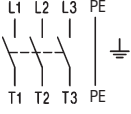

Ein-Ausschalter 6-polig 	20A	7,5kW	52x45	LTS20 SMA A6	1	0,29
	25A	10kW	52x45	LTS25 SMA A6	1	0,29
	32A	12,5kW	52x45	LTS32 SMA A6	1	0,29
	40A	16kW	52x45	LTS40 SMA A6	1	0,29
	63A	22kW	97x45	LTS63 SMA A6	1	0,34
	80A	22kW	97x45	LTS80 SMA A6	1	0,34

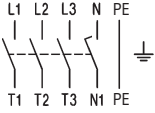
Ein-Ausschalter 8-polig 	20A	7,5kW	97x45	LTS20 SMA A8	1	0,31
	25A	10kW	97x45	LTS25 SMA A8	1	0,31
	32A	12,5kW	97x45	LTS32 SMA A8	1	0,31
	40A	16kW	97x45	LTS40 SMA A8	1	0,31
	63A	22kW	126x45	LTS63 SMA A8	1	0,42
	80A	22kW	126x45	LTS80 SMA A8	1	0,42

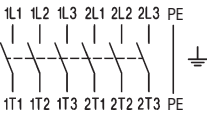
Umschalter 3-polig 	20A	7,5kW	97x45	LTS20 SMA U3	1	0,30
	25A	10kW	97x45	LTS25 SMA U3	1	0,30
	32A	12,5kW	97x45	LTS32 SMA U3	1	0,30
	40A	16kW	97x45	LTS40 SMA U3	1	0,30
	63A	22kW	97x45	LTS63 SMA U3	1	0,35

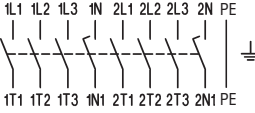

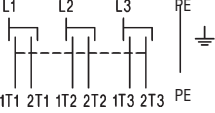

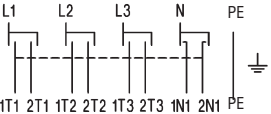









Umschalter 4-polig 	20A	7,5kW	97x45	LTS20 SMA U4	1	0,32
	25A	10kW	97x45	LTS25 SMA U4	1	0,32
	32A	12,5kW	97x45	LTS32 SMA U4	1	0,32
	40A	16kW	97x45	LTS40 SMA U4	1	0,32
	63A	22kW	126x45	LTS63 SMA U4	1	0,43

Lasttrennschalter isolierstoffgekapselt IP66, c(UL)us Type 4X

	AC21 690V	AC23 3x400V	Schild	Typ	VPE Stk.	Gewicht kg/Stk.	
Ein-Ausschalter 3-polig  	20A	7,5kW	64 □	LTS20 PF(L ¹⁾) A3	1	0,30	
	25A	10kW	64 □	LTS25 PF(L ¹⁾) A3	1	0,30	
	32A	12,5kW	64 □	LTS32 PF(L ¹⁾) A3	1	0,30	
	40A	16kW	64 □	LTS40 PF(L ¹⁾) A3	1	0,30	
	63A	22kW	64 □	LTS63 PFL A3	1	0,58	
	80A	22kW	64 □	LTS80 PFL A3	1	0,58	
	Ein-Ausschalter 4-polig  	20A	7,5kW	64 □	LTS20 PF(L ¹⁾) A4	1	0,31
25A		10kW	64 □	LTS25 PF(L ¹⁾) A4	1	0,31	
32A		12,5kW	64 □	LTS32 PF(L ¹⁾) A4	1	0,31	
40A		16kW	64 □	LTS40 PF(L ¹⁾) A4	1	0,31	
63A		22kW	64 □	LTS63 PFL A4	1	0,62	
80A		22kW	64 □	LTS80 PFL A4	1	0,62	
Ein-Ausschalter 6-polig  		20A	7,5kW	64 □	LTS20 PFL A6	1	1,39
	25A	10kW	64 □	LTS25 PFL A6	1	1,39	
	32A	12,5kW	64 □	LTS32 PFL A6	1	1,39	
	40A	16kW	64 □	LTS40 PFL A6	1	1,39	
	63A	22kW	64 □	LTS63 PFL A6	1	1,42	
	80A	22kW	64 □	LTS80 PFL A6	1	1,42	
	Anbauerschraubung M50/40 +PF3/M50 auf Anfrage						
Ein-Ausschalter 8-polig  	20A	7,5kW	64 □	LTS20 PFL A8	1	1,44	
	25A	10kW	64 □	LTS25 PFL A8	1	1,44	
	32A	12,5kW	64 □	LTS32 PFL A8	1	1,44	
	40A	16kW	64 □	LTS40 PFL A8	1	1,44	
	63A	22kW	64 □	LTS63 PFL A8	1	1,50	
	80A	22kW	64 □	LTS80 PFL A8	1	1,50	
	Anbauerschraubung M50/40 +PF3/M50 auf Anfrage						
Umschalter 3-polig  	20A	7,5kW	64 □	LTS20 PFL U3	1	1,39	
	25A	10kW	64 □	LTS25 PFL U3	1	1,39	
	32A	12,5kW	64 □	LTS32 PFL U3	1	1,39	
	40A	16kW	64 □	LTS40 PFL U3	1	1,39	
	63A	22kW	64 □	LTS63 PFL U3	1	1,42	
	Umschalter 4-polig  	20A	7,5kW	64 □	LTS20 PFL U4	1	1,44
		25A	10kW	64 □	LTS25 PFL U4	1	1,44
32A		12,5kW	64 □	LTS32 PFL U4	1	1,44	
40A		16kW	64 □	LTS40 PFL U4	1	1,44	
63A		22kW	64 □	LTS63 PFL U4	1	1,50	

1) PFL.... größerer Anschlußraum











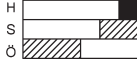

Zusatzmodule zum Anbau an Hauptschalter für Einbau und Zentralbefestigung

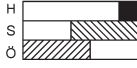
	für Schalter	Typ	VPE Stk.	Gewicht kg/Stk.
	4.Pol für 3-polige Hauptschalter			
		LTS20 ... bis LTS40 ... LTS63 ... , LTS80 ...	N40E N80E	1 1
	Hilfskontaktblock 1S + 1Ö			
		LTS20 ... bis LTS125 ...	LH11	1
	Hilfskontaktblock 1S + 1Ö überlappend			
		LTS20 ... bis LTS125 ...	LH11X	1
	Hilfskontaktblock 2Ö			
		LTS20 ... bis LTS125 ...	LH20V/02E	1
	PE-Klemme			
		LTS20 ... bis LTS80 ... LT125 E.. bis LT160 E..	PE80E LTXX-E/E	1 1
	N-Klemme			
		LTS20 ... bis LTS80 ... LT125 E.. bis LT160 E..	PEN80E LTXX-N/E	1 1
	Klemmenabdeckung 3-polig			
	LTS20 ... bis LTS80 ...	KLAD70	1	0,005
	LTS85.. bis LTS125. LT125.. bis LT160..	KLAD125 XX-KLAD3	1 1	0,01 0,02
	Netzseitige Klemmenabdeckung für 4. Pol			
	Netzseitig Verbraucherseitig	LTS20 ... bis LTS80.. LTS20 ... bis LTS80..	KLAD70N KLAD70NI	1 1
	Klemmenabdeckung 4-polig			
	LTS85.. bis LTS125. LT125.. bis LT160..	KLAD125 XX-KLAD4	1 1	0,01 0,02

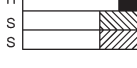
Zubehör zum Anbau an Hauptschalter für Einbau, Zentralbefestigung und Bodenmontage

	für Schalter	Typ	VPE Stk.	Gewicht kg/Stk.
	Zusatzschild gelb mit Aufschrift: HAUPTSCHALTER			
	für Schild 48 ^r für Schild 64 ^r	LTS.. .HN1.. LTS.. .HN4..	A91501 E91501	1 1
	Zusatzschild gelb mit Aufschrift: MAIN SWITCH			
	für Schild 48 ^r für Schild 64 ^r	LTS.. .HN1.. LTS.. .HN4..	A91524 E91524	1 1
	Flachsteckzunge 6,3 x 0,8mm für nachträglichen Anbau			
	LTS20 ... bis LTS40 ...	LG11073	10	0,001

Zusatzmodule zum Anbau an Hauptschalter für Bodenmontage und Reiheneinbau

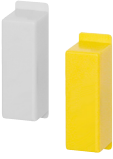
	für Schalter		Typ	VPE Stk.	Gewicht kg/Stk.	
	 N N1	LTS20 ... , LTS40 ...	N40V	1	0,035	
		LTS63 ... , LTS80 ...	N80V	1	0,042	
	 H 13 21 S 14 22 Ö	LTS20 ... bis LTS125 ...	LH11	1	0,02	
	 H 47 35 S 48 36 Ö	LTS20 ... bis LTS125 ...	LH11X	1	0,02	
	 H 13 23 S 14 24 S	LTS20 ... bis LTS80 ...	LH20V/02E	1	0,02	
	 PE PE	LTS20 ... bis LTS80 ...	PE80V	1	0,04	
		LT125 .. bis LT160 ..	LTXE-E/V	1	0,2	
	 N N	LTS20 ... bis LTS80 ...	PEN80V	1	0,04	
		LT125 .. bis LT160 ..	LTXE-N/V	1	0,2	
	Klemmenabdeckung 3-polig					
	LTS20 ... bis LTS40 ...	KLAD40	1	0,005		
	LTS63 ... bis LTS80 ...	KLAD70	1	0,005		
	LTS85.. bis LTS125. LT125.. bis LT160..	KLAD125 XX-KLAD3	1 1	0,01 0,02		
	Netzseitige Klemmenabdeckung für 4. Pol					
	Netzseitig	LTS63.., LTS80..	KLAD70N	1	0,002	
	Verbraucherseitig	LTS63.., LTS80..	KLAD70NI	1	0,002	
	Klemmenabdeckung 4-polig					
	LTS20 ... bis LTS40 ...	KLAD40	1	0,005		
	LTS85.. bis LTS125.	KLAD125	1	0,01		
	LT125.. bis LT160..	XX-KLAD4	1	0,02		
	Zusatzabdeckung SMA für					
	4. Pol	N40V, N80V	grau	LG8628-2	1	0,047
	Hilfskontakt PE und N-Klemme	LH.. PE80V, PEN80V	gelb	LG8628-7	1	0,047

Technische Daten

Daten nach IEC 947-3, IEC 947-5-1, VDE 0660, EN 60947-3, EN 60947-5-1

Typ	LTS20	LTS25	LTS32	LTS40	LTS63	LTS80	LTS85	LTS100	LTS125	LT160	
Hauptkontakte											
Thermischer Bemessungsbetriebsstrom I_{th} offen	A	20	25	32	40	63	80	85	100	125	160
Therm. Bemessungsbetriebsstrom I_{the} gekapselt	A	20	25	32	40	63	80	85	100	110	160
Bemessungsisolationsspannung U_i ¹⁾	V	690	690	690	690	690	690	1000 ³⁾	1000 ³⁾	1000 ³⁾	1000 ³⁾
Bemessungsbetriebsstrom I_e AC21A	A	20	25	32	40	63	80	85	100	125	160
Bemessungsbetriebsspannung U_e max. AC21A	V	690	690	690	690	690	690	1000	1000	1000	690
Einschaltvermögen I_{eff} 3x380-440V	A	160	190	220	300	370	440	600	725	850	1050
Ausschaltvermögen 3x220-240V	A	160	180	200	250	330	380	480	580	680	900
3x380-440V	A	160	180	200	250	330	380	480	580	680	850
3x660-690V	A	80	110	140	170	190	220	250	330	420	340
Trennerbedingungen erfüllt bis	V	690	690	690	690	690	690	1000	1000	1000	1000
Motorschalter AC3 3x400V	A	12	16	23	30	37	37	45	60	72	85
Motorschalter AC3 3x220-240V	kW	3	4	5,5	7,5	11	11	15	18,5	22	30
für betriebsmäßiges Schalten 3x380-440V	kW	5,5	7,5	11	15	18,5	18,5	22	30	37	45
3x660-690V	kW	5,5	7,5	11	15	18,5	18,5	22	30	37	37
Hauptschalter AC23 3x400V	A	16	20	25	32	45	45	60	72	85	110
Motorschalter, AC23A, 3x220-240V	kW	4	5,5	7,5	9	15	15	18,5	22	30	30
Hauptschalter, AC23B 3x380-440V	kW	7,5	10	12,5	16	22	22	30	37	45	55
Reparaturschalter 3x660-690V	kW	5,5	7,5	11	15	18,5	18,5	22	30	37	37
Bedingter Bemessungskurzschlußstrom 400V	kA _{eff}	10	10	10	10	10	10	10	10	5	30
Maximale Vorsicherung gL (gG) 400V	A	25	35	40	40	63	80	100	100	125	160
Bedingter Bemessungskurzschlußstrom 690V	kA _{eff}	10	5	3	1	5	1,5	10	10	5	30
Maximale Vorsicherung gL (gG) 690V	A	20	25	32	40	63	80	85	100	125	-
Mechanische Lebensdauer	x10 ³	200	200	200	200	100	100	100	100	100	100
Elektrische Lebensdauer	x10 ³	5	5	5	5	4	4	3	3	3	2
Bemessungskurzzeitstromfestigkeit (1s-Strom)	A	250	300	400	500	600	850	1000	1200	1500	3000
Verlustleistung pro Pol P/Pol [W]	E, Z	0,322	0,503	0,824	1,288	2,739	4,416	3,851	5,330	8,328	-
bei AC21 = I_{th}	V, SMA, PF	0,364	0,569	0,933	1,458	2,739	4,416	3,851	5,330	8,328	-
	R/Pol [mOhm]	E, Z	0,805	0,805	0,805	0,805	0,690	0,690	0,533	0,533	-
	V, SMA, PF	0,911	0,911	0,911	0,911	0,690	0,690	0,533	0,533	0,533	-
Zulässige Umgebungstemperatur Betrieb offen	-40°C bis +60°C (90°C) ⁵⁾										
gekapselt	-40°C bis +40°C										
Lagerung	-50°C bis +90°C ⁶⁾										
Anschlußquerschnitte	mm ²	0,5 - 10				1 - 25 ⁴⁾		4 - 50		max.95	
ein- oder mehrdrähtig	AWG	20 - 8 (10)				16 - 3 (10)		10 - 00 (10)		max.3/0	
feindrähtig	mm ²	0,5 - 6				4 - 16 ⁴⁾		10 - 35		max.70	
	AWG	20 - 10				16 - 6		8 - 2		max.2/0	
feindrähtig mit Aderendhülse	mm ²	0,5 - 6				0,75 - 16 ⁴⁾		6 - 35		max.50	
	AWG	20 - 10				16 - 6		8 - 2		max.1/0	
Klemmschraube		M3,5				M5		M6		M10	
Anzugsdrehmoment	Nm	1 - 1,7				2,8 - 4		1,7 - 4,5		14	
Hilfskontakte											
Bemessungsisolationsspannung U_i ¹⁾	V	690				690		690		690	
Thermischer Bemessungsbetriebsstrom I_{th} , I_{the}	A	10				10		10		16	
Schaltvermögen AC15 380-450V	A	2,5/1,5				2,5/1,5		2,5/1,5		6/4	
DC13 60-110V	A	2/0,4				2/0,4		2/0,4		-	
Bedingter Bemessungskurzschlußstrom	kA _{eff}	3				3		3		3	
Maximale Vorsicherung gL (gG)	A	10				10		10		16	
Anschlußquerschnitte	mm ²	0,75 - 2,5				0,75 - 2,5		0,75 - 2,5		max.4	
ein- oder mehrdrähtig	AWG	14 - 12				14 - 12		14 - 12		max.12	
feindrähtig (+ Aderendhülse)	mm ²	0,75 - 2,5 (1,5)				0,75 - 2,5 (1,5)		0,75 - 2,5 (1,5)		max.2,5	
	AWG	18 - 14				18 - 14		18 - 14		max.14	
Daten nach UL und cUL											
Typ	LTS20	LTS25	LTS32	LTS40	LTS63	LTS80	LTS85	LTS100	LTS125	LT160	
Bemessungsbetriebsspannung	V	600	600	600	600	600	600	600	600	600	
Ampere-Rating "General use"	A	20	25	32	40	63	80	85	100	125	
DOL-Rating 3-phase 110-120V	HP	1	1,5	2	2	3	5	7,5	10	15	
220-240V	HP	3	5	5	5	10	10	20	25	30	
440-480V	HP	7,5	10	10	10	20	20	40	50	60	
550-600V	HP	10	10	15	15	25	25	50	60	60	
DOL-Rating 1-phase 110-120V	HP	1	1	1	1	2	2	3	5	7,5	
200-208V	HP	1	2	2	2	3	3	7,5	10	10	
220-240V	HP	2	2	3	3	5	5	10	15	15	
Fuse size (RK5) Manual Motor Controller	A	40	50	50	70	90	110	125	125	125	
5kA / 600V Motor Disconnect	A	40	50	50	50	70	70	125	125	125	
Tightening torque	Nm	1,7	1,7	1,7	1,7	2,8-4	2,8-4	1,7-4,5	1,7-4,5	1,7-4,5	

1) gilt für: Netze mit geerdetem Sternpunkt, Überspannungskategorie I bis III, Verschmutzungsgrad 3 (Norm-Industrie): $U_{mp} = 6kV$.
 2) Fuse RK1 / 10kA / 600V
 3) $U_{mp} = 8kV$
 4) LTS63...U. mehrdrähtig 16mm², eindrähtig 10mm²
 5) Stromreduktion entsprechend Anschlußkabel
 6) für Schalter mit transparenten Schildern 48 □ max. 65°C

Maße in mm

Hauptschalter, Lasttrennschalter LT(S)..

Einbau LT.. E(HN)..
Ein-Aus-Schalter 3-polig, 4-polig

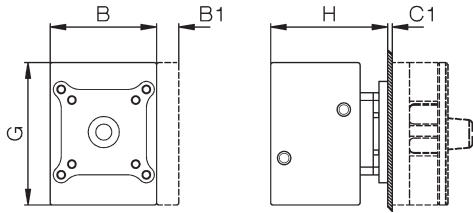

Ein-Aus-Schalter 6-polig, 8-polig
Umschalter 3-polig, 4-polig

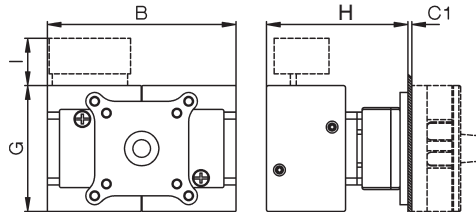

Bohrplan

Montageschraube: J3631N M=1,2-1,4 Nm

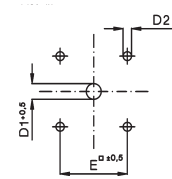

Zentralbefestigung LTS.. Z(HN)..
Ein-Aus-Schalter 3-polig, 4-polig

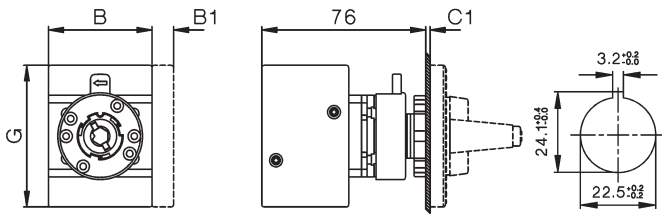

Bohrplan

Montage der Zusatzmodule LTS20 - LTS80
Einbau, Zentralbefestigung

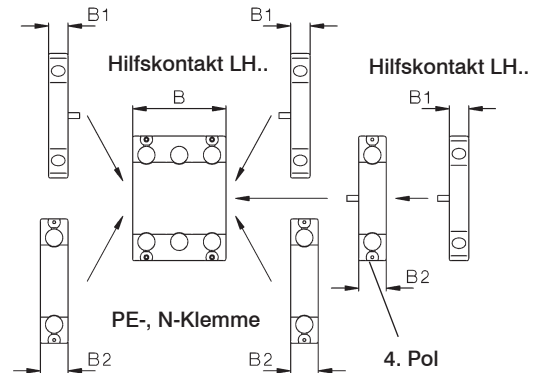

Typ	Schild	Sperrvorrichtung	Umschalter		3-polig		4-polig		Hilfskontakte	4.Pol PE				3,4-polig		3,4-polig		
			Ausschalter	A	B	B	B	B		B1	B2	C1	D1	D2	E	F	G	H
LTS20-80..	48 □, SV1		48	48	62,5	-	-	10	14,5	1-5	9	5	36	-	64	49	74	24
LTS20-80..	64 □, SV4, SV164		64	48	62,5	97	126	10	14,5	1-5	9	5	48	-	64	49	74	24
LTS85-125..	64 □, SV4		64	78	78	-	-	10	-	1-5	9	5	48	-	85	55	-	-
LTS85-125..	88 □, SV488		88	78	78	-	-	10	-	1-5	9	6	68	-	85	55	-	-
LT160	88 □, SV34		88	112	150	224	-	-	-	1-4	13-17	6	68	49,3	108	96	98	-

Schild
48 □

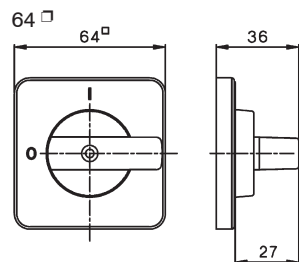
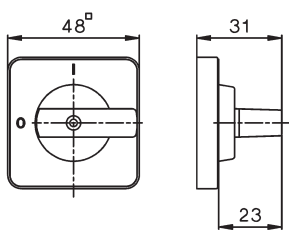

Sperrvorrichtungen
SV1

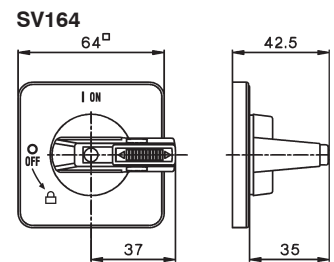
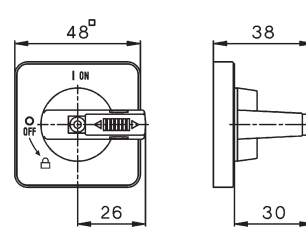

Sperrvorrichtungen
SV4

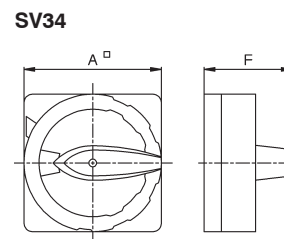
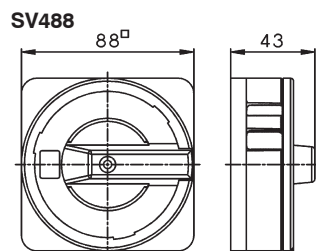
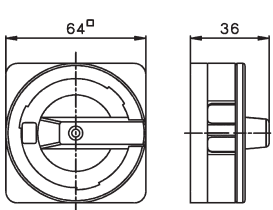

Verlängerte Schalterwelle + VW"x"

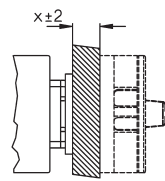

Maße in mm

Hauptschalter, Lasttrennschalter LT(S)..

Bodenmontage LTS.. VZV(HN)..

Ein-Aus-Schalter 3-polig, 4-polig

L = X - 40 ± 3 für LTS20 - 80

L = X - 44 ± 3 für LTS85 - 125

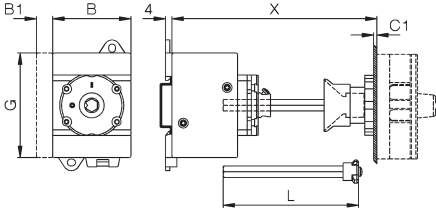

6-polig
nur für LTS20 - 40
L = X - 40 ± 3

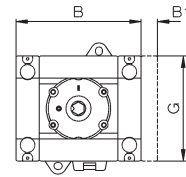

Ein-Aus-Schalter 6-polig, 8-polig
Umschalter 3-polig, 4-polig
L = X - 60 ± 3

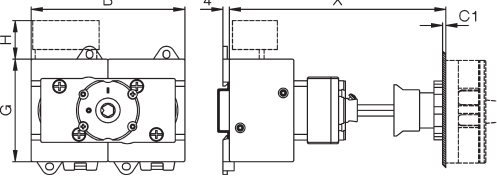

Bohrplan

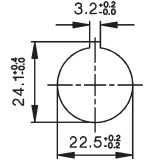

Bodenmontage LT(S).. V(HN)..

Ein-Aus-Schalter 3-polig, 4-polig

L = T - 60 ± 3 für LTS20 - 80

L = T - 64 ± 3 für LTS85 - 125

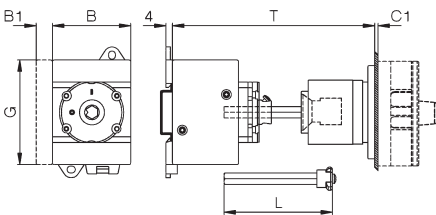

6-polig
nur für LTS20 - 40
L = T - 60 ± 3

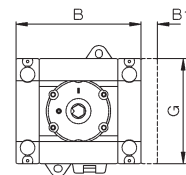

Ein-Aus-Schalter 6-polig, 8-polig
Umschalter 3-polig, 4-polig
L = T - 80 ± 3 gilt nur für Schalter LTS..

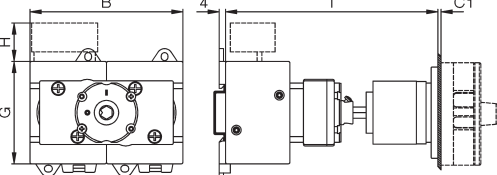

Bohrplan

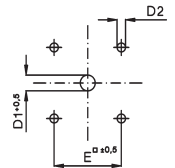

Bodenmontage LTS.. VZ(HN)..

Ein-Aus-Schalter 3-polig, 4-polig

Vorzugswerte für X: 80, 85, 104, 129

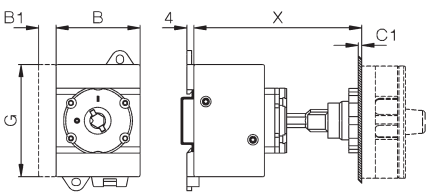

6-polig
nur für LTS20 - 40

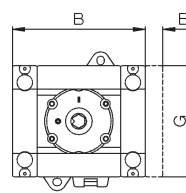

Ein-Aus-Schalter 6-polig, 8-polig
Umschalter 3-polig, 4-polig

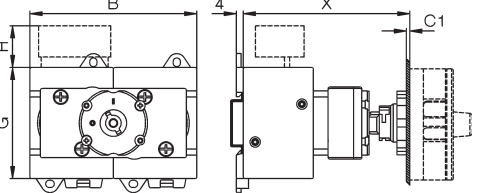

Bohrplan

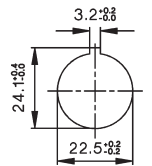

Typ	Umschalter Ausschalter Schild oder Sperrvorrichtung	3,4-polig					Hilfs- kontakte PE			C1	D1	D2	D3	E	G	K	K1	J
		3-polig	4-polig	6-polig	8-polig	4.Pol	B1	B2	H									
LTS20 -40	64 □, SV4, SV164	64	48	48	77	97	10	14,5	24	1-5	9	5	M4	48	64	25	48	70
LTS63, 80	64 □, SV4, SV164	64	48	62,5	97	126	10	14,5	24	1-5	9	5	M4	48	64	25	48	70
LTS85-125..	64 □, SV4	64	78	78	-	-	10	-	-	1-5	9	5	M4	48	85	38	-	90
LT125/160	88 □, SV34	88	112	150	224	-	-	-	-	1-4	13/27 ²⁾	6	M6	68	108	36	-	120

Bodenmontage Ein-Aus-Schalter LTS20 - LTS80

3-polig, 4-polig
6-polig LTS20 -40

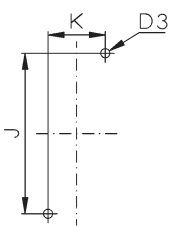

6-polig, 8-polig
Umschalter

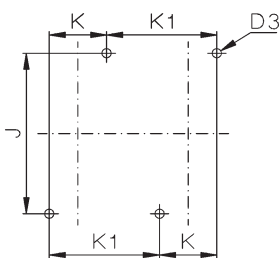

LTS85-125, LT160

3-polig, 4-polig

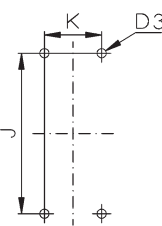

Montage der Zusatzmodule LTS20 - LTS80

Bodenmontage, Reiheneinbau

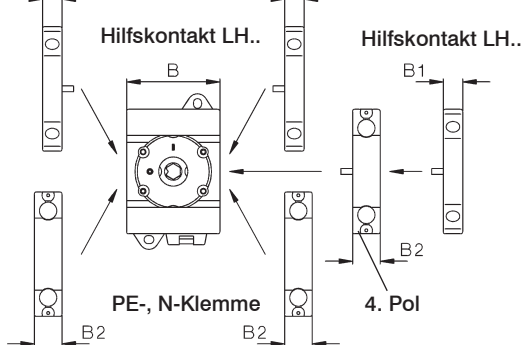

1) Ø 22-25 nur für LT80(100) VH(N)34 ..
2) Ø 26-30 nur für LT125(160) VH(N)34 ..

Maße in mm

Hauptschalter, Lasttrennschalter LT(S)..

Reiheneinbau LT(S).. SMA(HN)..

Ein-Aus-Schalter 3-polig, 4-polig

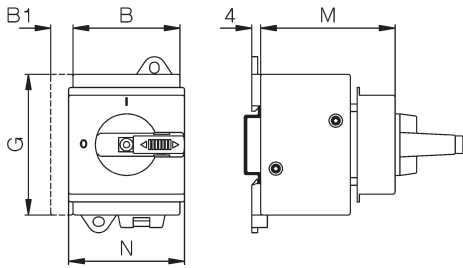

Ein-Aus-Schalter 6-polig
nur für LTS20 - LTS40

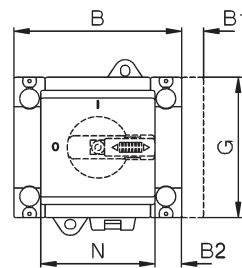

Ein-Aus-Schalter 6-polig, 8-polig
Umschalter 3-polig, 4-polig

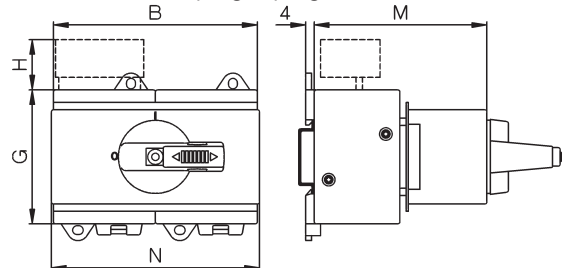

Typ	Sperrvorrichtung	Umschalter Ausschalter								G	U3/U4				H				
		A3	A4	A6	A8	U3	U4	Hilfskontakt	4.Pol PE		A3	A6	A8	U3		U4			
LTS20 - 40	SV1, SV164	48	48	77	96	96	96	10	14,5	64	60	60	74	52	52	97 ²⁾	97 ²⁾	97 ²⁾	24
LTS63, 80	SV1, SV164	48	62,5	96	125	96	125	10	14,5	64	60	79	79	52	97 ²⁾	126 ¹⁾	97 ²⁾	126 ¹⁾	-
LTS85-125..	SV164	78	78	-	-	-	-	10	-	85	60	-	-	78	-	-	-	-	-

Reiheneinbau mit niedrigem Griff LTS SMAHN1.. +SV1N

Hauptschalter 3-polig, 4-polig LTS20 - LTS80

Sperrvorrichtung SV1

Sperrvorrichtung SV164

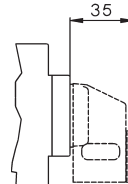
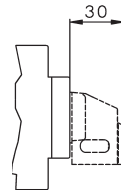
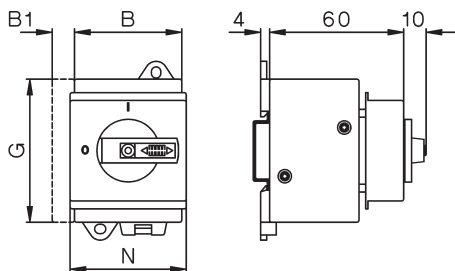

1) original Abdeckung

2) abbrechbare Laschen

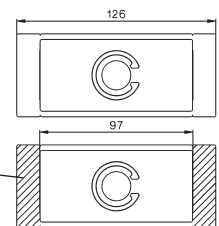

Reparaturschalter isolierstoffgekapselt LT(S)..PF..

Typ	Pole	Größe	A	B	C	D1	D2	E	F	H
LTS20 PFH.. A. - LTS40 PFH.. A. ³⁾	3, 4	PF1	130	98	120	2x25,5/20,5	-	75	100	76
LTS20 PFLH.. A., LTS40 PFLH A. ³⁾	3, 4	PFL	180	98	170	2x25,5/20,5 / 16,5/12,5-	-	75	150	76
LTS20 PFLH.. A. - LTS40 PFLH.. A. ⁴⁾	6	PFL2	200	140	188,5	40,5/32,5+16,5+12,5	-	100	160	86
LTS63 PFLH.. A. - LTS80 PFLH.. A. ⁴⁾	3, 4	PFL2	200	140	188,5	40,5/32,5+16,5+12,5	-	100	160	86
LTS85 PFLH.. A. - LTS125 PFLH.. A. ⁵⁾	3, 4	PFL2	200	140	188,5	40,5/32,5+16,5+12,5	-	100	160	86
Suffix + PF3	3, 4	PFL3	240	176	228,5	2x40,5/32,5	-	120	200	120
Suffix + PF3/M50	3, 4	PFL3	240	176	228,5	50,5/40,5	-	120	200	120
LTS20 PFLH.. A. - LTS40 PFLH.. A. ⁵⁾	8	PFL3	240	176	228,5	2x40,5/32,5	-	120	200	120
LTS63 PFLH.. A. - LTS80 PFLH.. A. ⁵⁾	6, 8	PFL3	240	176	228,5	2x40,5/32,5	-	120	200	120
Suffix + M50	6, 8	PFL3	240	176	228,5	50,5/40,5	-	120	200	120
LT160 PF..	3	PF4	300	200	-	2x50,5	25,5	172	272	172
LT160 PF..	4	PF5	300	280	-	2x50,5	-	254	254	180

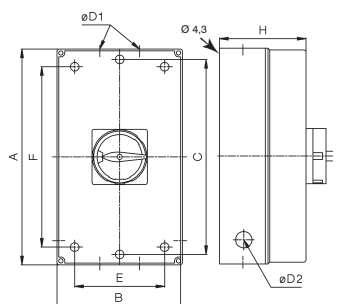

Lasttrennschalter isolierstoffgekapselt LTS..PF..

Typ	Pole	Größe	A	B	C	D1	E	F	H
LTS20 PF A., LTS40 PF A. ³⁾	3, 4	PF1	130	98	121	2x25,5/20,5	75	100	76
LTS20 PFL A., LTS40 PFL A. ³⁾	3, 4	PFL	180	98	170	2x25,5/20,5 / 16,5/12,5	75	150	76
LTS63 PFL A., LTS80 PFL A. ⁴⁾	3, 4	PFL2	200	140	188,5	40,5/32,5+16,5+12,5	100	160	86
Suffix + PF3	3, 4	PFL3	240	176	228,5	2x40,5/32,5	120	200	120
Suffix + PF3/M50	3, 4	PFL3	240	176	228,5	50,5/40,5	120	200	120

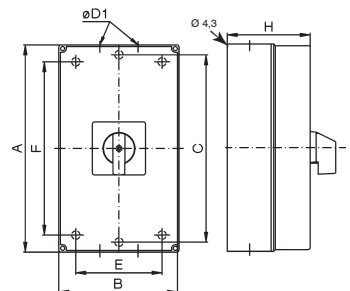

Maximale Bestückung in diesem Gehäuse:

3) LTS40 PF. A5 + LH11

4) LTS40 PFL.. A6, LTS80 PFL.. A5 + LH11, LTS125 PFL.. A4 + LH11

5) LTS40 PFL.. A10, LTS40 PFL.. U4 + LH11, LTS80 PFL.. A8, LTS80 PFL..; A6 + LH11,

LTS40 PFL.. U3 + LH11; LTS125 PFL.. A4+LH11